

# UVD6361DP

## Universal 36" Telescopic Downdraft System

### DIMENSIONS AND INSTALLATION INFORMATION (IN INCHES)

**NOTE:** Telescopic downdraft vents are not recommended to be installed with cooktops that are flush mounted.

Approved for use with the following Monogram, GE Profile™ Series and GE® Series cooktops—36" electric models, 36" gas-sealed burner models and 36" induction models.

### NOT APPROVED FOR USE WITH STANDARD BURNER GAS COOKTOPS.

**NOTE:** The countertop must be at least 26" deep with a flat surface area of 23-1/2" or more, front to back. In addition, other clearances to the front edge of the countertop must be considered.

**NOTE:** Dimensions shown are for reference only. Before cutting out countertop, refer to instructions packed with downdraft and cooktop.

**NOTE:** Installation on cabinets/countertops against the wall will not be possible in most applications. Against the wall installations are limited to dimension requirements. Refer to installation instructions packed with product for further details.

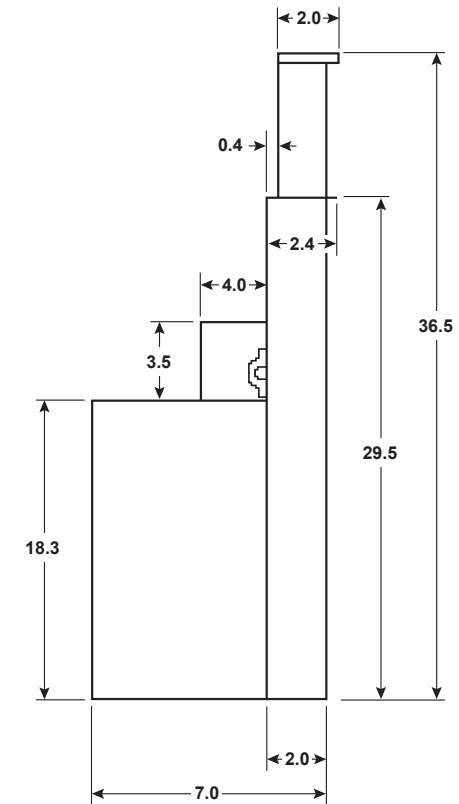
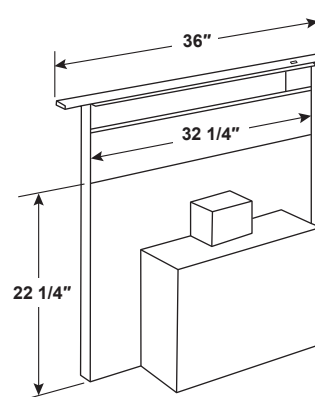

Open Chimney View













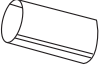



For answers to your Monogram, GE Café™, GE Profile™ or GE Appliances product questions, visit our website at [geappliances.com](http://geappliances.com) or call GE Answer Center® Service, 800.626.2000.

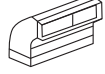

# UVD6361DP

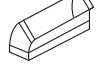
## Universal 36" Telescopic Downdraft System

### VENTING DUCT INFORMATION

| DUCT PIECES  | EQUIVALENT LENGTH*      | DUCT PIECES   | EQUIVALENT LENGTH* |
|--|-------------------------|---|--------------------|
|  6" ROUND STRAIGHT                    | 1 ft. (per foot length) |  3-1/4" X 10" TO 6" ROUND TRANSITION   | 2 ft.              |
|  3-1/4" X 10" STRAIGHT                | 1 ft. (per foot length) |  6" ROUND TO 3-1/4 X 10" TRANSITION 90° ELBOW  | 4 ft.              |
|  6" 90° ELBOW                         | 12 ft.                  |  3-1/4" X 10" TO 6" ROUND TRANSITION 90° ELBOW   | 4 ft.              |
|  6" 45° ELBOW                         | 7 ft.                   |  6" ROUND WALL CAP WITH DAMPER   | 24 ft.             |
|  3-1/4" X 10" 90° ELBOW               | 14 ft.                  |  3-1/4" X 10" WALL CAP WITH DAMPER   | 24 ft.             |
|  3-1/4" X 10" 45° ELBOW               | 12 ft.                  |  6" ROUND ROOF CAP   | 33 ft.             |
|  3-1/4" X 10" 45° ELBOW               | 33 ft.                  | <b>SHOULD NOT EXCEED 100 EQUIVALENT FT.</b><br>*Equivalent length of duct pieces is based on actual test conducted by GE Evaluation Engineering and reflects requirements for good venting performance. |                    |
|  6" ROUND TO 3-1/4 X 10" TRANSITION | 2 ft.                   |   |                    |

### PLAN THE DUCTWORK

1. This downdraft blower system is designed for use with 3-1/4" x 10" ductwork (can be transitioned to 6" round). Two different discharge directions are available with side-to-side adjustment for the accurate alignment of ductwork.
2. For best performance: choose the ducting option which allows the shortest length of ductwork and a minimum number of elbows and transitions. Check location of floor joists, wall joists, wall studs, electrical wiring or plumbing for possible interference.

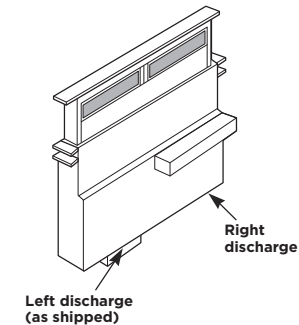

### STEPS TO DETERMINE FLEXIBLE DUCTING'S EQUIVALENT LENGTH

1. Measure the actual amount of offset (Maximum 3" recommended). The effect upon airflow is dependent upon the amount of offset.
2. Calculate the equivalent ducting allowances using:  
 $(\text{__in. offset}) \times (14 \text{ ft. per inch}) = \text{__ft. equivalent length.}$
3. Total equivalent length of ducting should not exceed the maximum recommendation of 100 feet for optional venting performance.



For answers to your Monogram, GE Cafe™, GE Profile™ or GE Appliances product questions, visit our website at [geappliances.com](http://geappliances.com) or call GE Answer Center® Service, 800.626.2000.

# UVD6361DP

## *Universal 36" Telescopic Downdraft System*

### **FEATURES AND BENEFITS**

500 CFM – Make sure everyone is focused only on your food with a 500-CFM venting system that removes smoke, grease, odors and moisture from the air.

Adjustable fan speed – Adjust your vents to match your cooking techniques with infinite fan control that removes grease, odors and moisture.

Grease filters – Keep your clean-up to a minimum with a removable grease filter that helps eliminate hand scrubbing.

Aluminum mesh filters – Easy to remove, dishwasher safe.

Hides into countertop – Raises over cooktop surface and retracts when not in use.

Model UVD6361DPBB – Black

