

Use & Care MANUAL

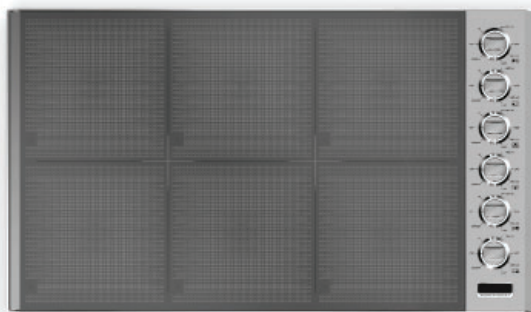
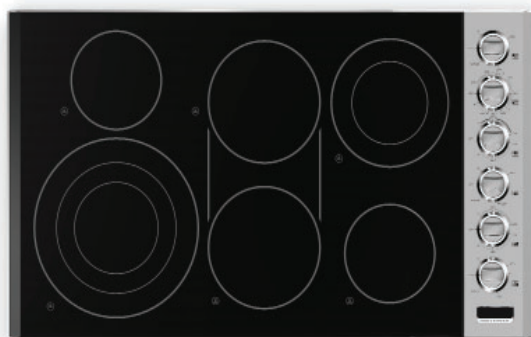

5 SERIES

Built-In Electric Cooktops
Built-In Induction Cooktops

VECU530(1) / VECU536(1)

VICU530(1) / VICU536(1)

Congratulations

Congratulations and welcome to the elite world of Viking ownership. We hope you will enjoy and appreciate the care and attention we have put into every detail of your new, state-of-the-art cooktop.

Your cooktop is designed to offer years of reliable service. This Use and Care Manual will provide you with the information you need to become familiar with your cooktop's care and operation.

Your complete satisfaction is our ultimate goal. If you have any questions or comments about this product, please contact the dealer from whom you purchased it, or contact our Consumer Support Center at 1-888-845-4641.

We appreciate your choice of a our product and hope that you will again select our products for your other major appliance needs.

For more information about the complete and growing selection of appliances, visit us online at vikingrange.com

Table of Contents

Getting Started

Warnings and Important Information	3
Before Using Cooktop	6

Product Controls

Cooktop Features	7
------------------------	---

Operation

Surface Operation	8
-------------------------	---

Product Care

Cleaning and Maintenance	12
Service Information	14
Warranty	15

Important – Please Read and Follow

Warning and Important Safety Instructions appearing in this manual are not meant to cover all possible conditions and situations that may occur. Common sense, caution, and care must be exercised when installing, maintaining, or operating this appliance.

ALWAYS contact the manufacturer about problems or conditions you do not understand.

Recognize Safety Symbols, Words, Labels

 **DANGER**

Hazards or unsafe practices which **WILL** result in severe personal injury or death

 **WARNING**

Hazards or unsafe practices which **COULD** result in death or severe personal injury

 **CAUTION**

Hazards or unsafe practices which **COULD** result in minor personal injury or property damage.

All safety messages will identify the hazard, tell you how to reduce the chance of injury, and tell you what can happen if the instructions are not followed.

Read and follow all instructions before using this appliance

to prevent the potential risk of fire, electric shock, personal injury or damage to the appliance as a result of improper usage of the appliance. Use appliance only for its intended purpose as described in this manual.

To ensure proper and safe operation: Appliance must be properly installed and grounded by a qualified technician. **DO NOT** attempt to adjust, repair, service, or replace any part of your appliance unless it is specifically recommended in this manual. All other servicing should be referred to a qualified servicer. For proper and safe operation, this unit is not intended to be operated by an external timer or separate remote control system.

 **WARNING**

 To avoid risk of property damage, personal injury or death; follow information in this manual exactly to prevent a fire or explosion.

 **WARNING**

 **DO NOT** store or use gasoline or other flammable vapors and liquids in the vicinity of this or any appliance.

To Prevent Fire or Smoke Damage

- Be sure all packing materials are removed from the appliance before operating it.
- Keep area around appliance clear and free from combustible materials, gasoline, and other flammable vapors and materials.
- If appliance is installed near a window, proper precautions should be taken to prevent curtains from blowing over burners.
- **NEVER** leave any items on the cooktop. The hot air from the vent may ignite flammable items and may increase pressure in closed containers which may cause them to burst.
- Many aerosol-type spray cans are **EXPLOSIVE** when exposed to heat and may be highly flammable. Avoid their use or storage near an appliance.
- Many plastics are vulnerable to heat. Keep plastics away from parts of the appliance that may become warm or hot. **DO NOT** leave plastic items on the cooktop as they may melt or soften if left too close to the vent or a surface element.
- Combustible items (paper, plastic, etc.) may ignite and metallic items may become hot and cause burns. **DO NOT** pour spirits over hot foods.

Important – Please Read and Follow

In Case of Fire

Turn off appliance and ventilating hood to avoid spreading the flame. Extinguish flame, then turn on hood to remove smoke and odor.

- Smother fire or flame in a pan with a lid or cookie sheet.
- **NEVER** pick up or move a flaming pan.
- **DO NOT** use water on grease fires. Use baking soda, a dry chemical or foam-type extinguisher to smother fire or flame.

Cooking Safety

- **ALWAYS** place a pan on a surface element before turning it on. Be sure you know which knob controls which surface element. Make sure the correct element is turned on. When cooking is completed, turn element off before removing pan.
- **NEVER** leave a surface cooking operation unattended, especially when using a high heat setting or when deep fat frying. Boil overs cause smoking and greasy spillovers may ignite. Clean up greasy spills as soon as possible. **DO NOT** use high heat for extended cooking operations.
- **NEVER** heat an unopened container on the surface element. Pressure build-up may cause container to burst resulting in serious personal injury or damage to the appliance.
- Use dry, sturdy pot holders. Damp pot holders may cause burns from steam. Dishtowels or other substitutes should **NEVER** be used as pot holders because they can trail across hot surface elements and ignite or get caught on appliance parts.
- **ALWAYS** let quantities of hot fat used for deep fat frying cool before attempting to move or handle.
- **DO NOT** let cooking grease or other flammable materials accumulate in or near the appliance, hood, or vent fan. Clean hood frequently to prevent grease from accumulating on hood or filter. When flaming foods under the hood, turn the fan off.
- **NEVER** wear garments made of flammable material or loose fitting or long-sleeved apparel while cooking. Clothing may ignite or catch on cookware handles.
- **PREPARED FOOD WARNING:** Follow food manufacturer's instructions. If a plastic frozen food container and/or its cover distorts, warps, or is otherwise damaged during cooking, immediately discard the food and its container. The food could be contaminated.
- If you are "flaming" liquor or other spirits under an exhaust, **TURN THE FAN OFF**. The draft could cause the flames to spread out of control.
- This appliance is not intended for use by persons (including children) with reduced physical, sensory or mental capabilities, or lack of experience and knowledge, unless they have been given supervision or instruction concerning use of the appliance. Children should be supervised to ensure that they do not play with the appliance.
- Use pans with flat bottoms and handles that are easily grasped and stay cool. Avoid using unstable, warped, easily tipped or loose-handled pans. Pans with heavy handles (especially small pans) could be unstable and tip easily. Pans that are heavy to move when filled with food may also be hazardous.
- Be sure cookware is large enough to properly contain food and avoid boil overs. Pan size is particularly important in deep fat frying. Pan should accommodate the volume of food that is to be added as well as the bubble action of fat.
- To minimize burns, ignition of flammable materials and spillage due to unintentional contact with the cookware, **DO NOT** extend handles over adjacent burners. **ALWAYS** turn pan handles toward the side or back of the appliance, not out into the room where they are easily hit or reached by children.
- **NEVER** let a pan boil dry as this could damage the cookware and the appliance.
- This appliance has been tested for safe performance using conventional cookware. **DO NOT** use any devices or accessories that are not specifically recommended in this guide. **DO NOT** use eyelid covers for the surface units. The use of devices or accessories that are not expressly recommended in this manual can create serious safety hazards, result in performance problems, and reduce the life of the components of the appliance.
- Use proper pan material. Refer to "Before Using Cooktop" section for recommended cookware. Proper relationship of cookware to surface unit will also improve efficiency.

WARNING

The appliance and its accessible parts become hot during use. Care should be taken to avoid touching heating elements. To avoid burns and scalds children should be kept away. Children less than 8 years of age shall be kept away unless continuously supervised.

CAUTION

DO NOT store items of interest to children over the unit. They could be seriously injured when climbing to reach these items. Children should be supervised to ensure that they do not play with the appliance.

Important – Please Read and Follow

Heating Elements and Glass Ceramic Cooking Surfaces

- **NEVER** touch the glass surface areas directly on or adjacent to the heating elements when the cooktop is in use.
- Heating elements may be hot even though they are dark in color. Areas near elements may be hot enough to cause burns.
- During and after use, **DO NOT** touch or let clothing or other flammable material contact surface of cooktop or areas near heating elements, until they have had sufficient time to cool.
- **DO NOT COOK ON BROKEN COOKING SURFACE.** If cooking surface should break, cleaning solutions and spillovers may penetrate the broken cooking surface and create a risk of electric shock. Contact a qualified technician immediately.

Cleaning Safety

- Turn off all controls and wait for appliance parts to cool before touching or cleaning them. **DO NOT** touch the surface elements or surrounding areas until they have had sufficient time to cool.
- Clean appliance with caution. Use care to avoid steam burns if a wet sponge or cloth is used to wipe spills on a hot surface. Some cleaners can produce noxious fumes if applied to a hot surface.
- A steam cleaner is not to be used for cleaning this appliance.

Induction Cooktops – Radio Interference

This unit generates, uses, and can radiate radio frequency energy and, if not installed and used in accordance with the instructions, may cause harmful interference to radio communications. However, there is no guarantee that interference will not occur in a particular installation. If this unit does cause harmful interference to radio or television reception, which can be determined by turning the unit off and on, the user is encouraged to try to correct the interference by one or more of the following measures:

- Reorient or relocate the receiving antenna
- Increase the distance between the unit and receiver
- Connect the unit into an outlet on a circuit different from that to which the receiver is connected.

KEEP THESE INSTRUCTIONS FOR FUTURE REFERENCE.

⚠ WARNING

 **BURN HAZARD**
To avoid risk of injury or death, make sure all controls are OFF and surface is COOL before cleaning. Failure to do so can result in burns

⚠ WARNING

 **BURN HAZARD**
To avoid risk of injury, **DO NOT** touch the electric cooktop glass during usage. Surface will be hot when in use.

⚠ WARNING

 **ELECTRIC SHOCK HAZARD**
If the surface is cracked, switch off the appliance to avoid the possibility of electric shock.

Before Using Cooktop

Ceramic Glass Cooktop

All products are wiped clean with solvents at the factory to remove any visible signs of dirt, oil, and grease which may have remained from the manufacturing process. **Clean your glass top before the first time you use it.** A thorough cleaning with a glass top cleaner is recommended.

Cooking Utensils

Each cook has his or her own preference for the particular cooking utensils that are most appropriate for the type of cooking being done. For best results, refer to table below. This is a matter of personal choice. As with any cookware, yours should be in good condition and free from excessive dents on the bottom to provide maximum performance and convenience.

Electric Cooktop Cooking Utensil Guidelines

Type	Responses to Temperature Changes	Recommended Usage
Aluminum	Heats and cools quickly.	Frying, braising, roasting. May leave metal markings on glass.
Cast Iron	Heats and cools slowly.	Not recommended. Retains excessive heat and may damage cooktop.
Copper, Tin lined	Heats and cools quickly.	Gourmet cooking, wine sauces, egg dishes.
Enamel Ware	Response depends on base metal.	Not recommended. Imperfections in enamel may scratch cooktop.
Glass Ceramic	Heats and cools slowly.	Not recommended. Heats too slowly. Imperfections in enamel may scratch cooktop.
Stainless Steel	Heats and cools at moderate rate.	Soups, sauces, vegetables, general cooking.

Cooktop Features

30"W. Electric Cooktop

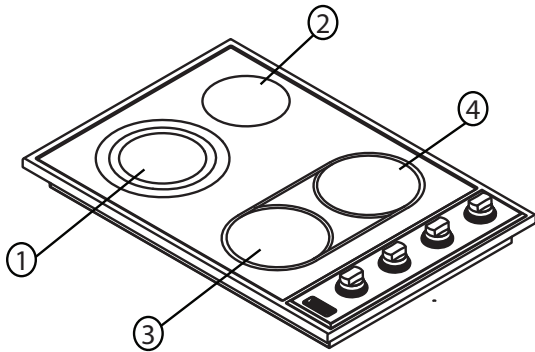

- 1. LF - 12" triple element - 1100 W / 1000 W / 1100 W
- 2. LR - 6" element - 1200 W
- 3. RF - 8-1/2" element - 1800 W
- 4. RR - 8-1/2" dual element - 1000 W / 1000 W
Bridge element - 800 W

36"W. Electric Cooktop

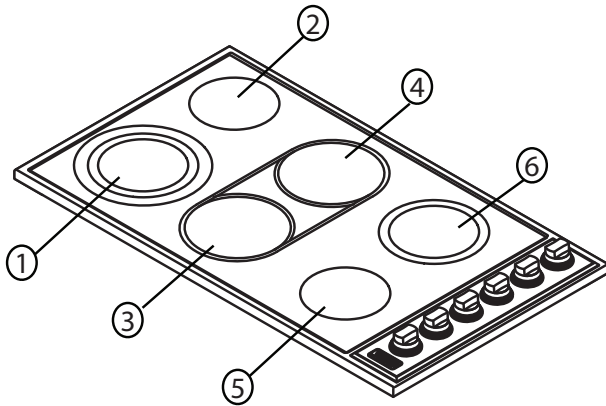

- 1. LF - 12" triple element - 1100 W / 1000 W / 1100 W
- 2. LR - 6" element - 1200 W
- 3. CF - 8-1/2" element - 1800 W
- 4. CR - 8-1/2" element - 1800 W
Bridge element - 800 W
- 5. RF - 6" element - 1200 W
- 6. RR - 8-1/2" dual element - 1000 W / 1000 W

30"W. Induction Cooktop

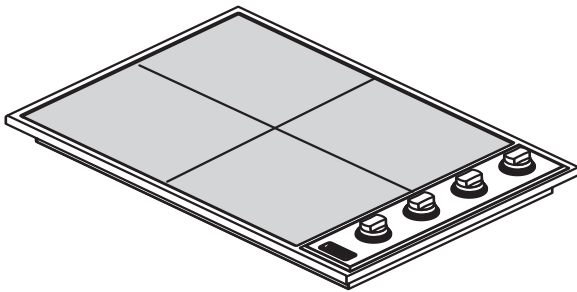

All Induction elements 2300 W / 3700 W

36"W. Induction Cooktop

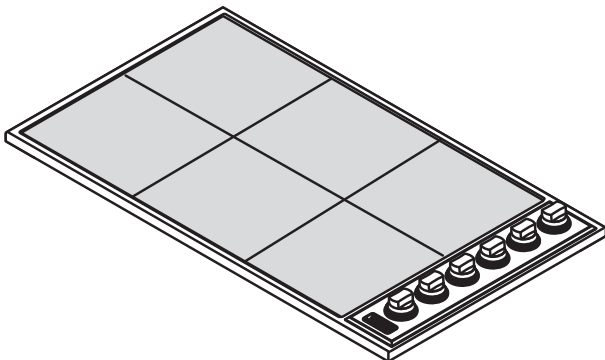

All Induction elements 2300 W / 3700 W

Surface Operation

⚠ CAUTION

Metallic objects such as knives, forks, spoons, and lids should not be placed on the cooktop surface since they can get hot.

⚠ WARNING

Unattended cooking with fat or oil can be dangerous and may result in fire. **NEVER** try to extinguish a fire with water, but switch off the appliance and then cover flame e.g. with a lid or a fire blanket.

⚠ CAUTION

DO NOT heat empty cookware or let cookware boil dry. The cookware can absorb an excessive amount of heat very quickly, resulting in possible damage to the cookware and ceramic glass.

⚠ CAUTION

After use, switch the element to the "OFF" position. Do not rely on the pan detector.

Electric Cooktop Controls

Operating Single Elements

All burners have variable controls. Push and turn the knob to desired setting.

Operating Double Elements

Dual elements are controlled by a single knob which can activate the inner element for smaller pots or both the inner and outer element for larger pots.

Push and turn the knob to either the single line settings for the inner element only or to the double line settings for the inner and outer element.

Operating Triple Elements

Triple elements are controlled by single knob which can activate the inner element for smaller pots, inner and center elements or inner, center and outer elements for larger pots.

Push and turn the knob to either the single line settings for the inner element only, double line settings for the inner and center element or to the triple line settings for inner, center, and outer setting.

Rear / Bridge Element

The control knob can activate the rear single element for use with a single pot or the rear element and the center bridge for use with a large rectangular pot or griddle application. For griddle applications, use front element along with the rear/bridge element.

Push in and turn the control knob counterclockwise to the desired setting to operate the single element. Push and turn the control knob clockwise to activate the rear and bridge element. Both elements will cycle on and off to maintain the desired heat setting.

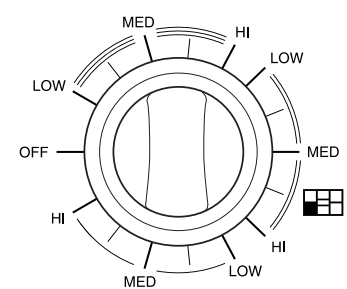
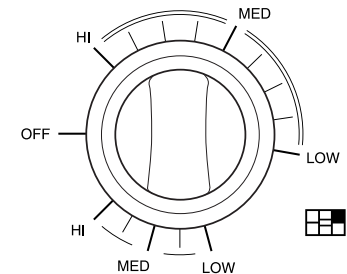
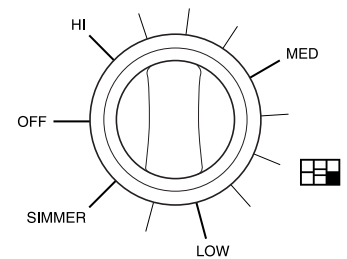

Surface Operation

Induction Cooktop Controls

Induction Cookware

Induction cooking utilizes magnetic power which reacts with iron in the base of cookware, instantly transforming the pot or pan into the heat source. The heat stops when the cookware is removed. Your cookware **MUST** have a magnetic layer of steel for your induction cooktop to operate properly. The cookware should have a flat, heavy magnetic bottom and straight sides with a diameter of 5" (13 cm) to 12" (31 cm). The induction cookware should be in good condition and free from excessive dents on the bottom to provide maximum performance and convenience.

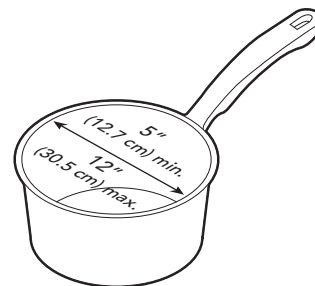

All Viking cookware is induction friendly, as are most other high-end brands of stainless steel and enamel cookware. Most cookware will be suitable for your induction cooktop if a magnet adheres to the bottom surface.

Cookware that is **NOT** suitable for your induction cooktop includes pottery, glass, aluminum, copper, bronze, and any type of cookware with a footed base.

Hot Surface Indicator Lights

The cooktop has hot surface indicator lights. They are located to the bottom left of each burner. When the corresponding element is turned to SIMMER, LOW, MED, or HI, the indicator light will flash blue if there is no pot or will remain solid blue while cooking. When the corresponding element is turned to BOOST, the indicator light will flash white if there is no pot and will remain solid white while cooking. After turning the element off, the indicator light will continue to flash alternating between blue and white until the surface has cooled.



Operating Elements

All burners have variable heat settings. Turn the knob clockwise SIMMER, LOW, MED, or HI Settings.

The final setting once you have turned the knob clockwise to its max is the BOOST setting. Boost mode can be activated by over-rotating the knob and holding until you hear the beep. The indicator light will turn white indicating that boost mode is active. Boost mode temporarily increases the power to the element allowing for faster heat up times. It is recommended to use this function for boiling water or other liquids. You can only boost on element per zone at the same time. (Refer to Power Sharing for zones.) Boost only operates for 10 minutes then automatically reduces to the high setting indicated by the indicator light turning blue.

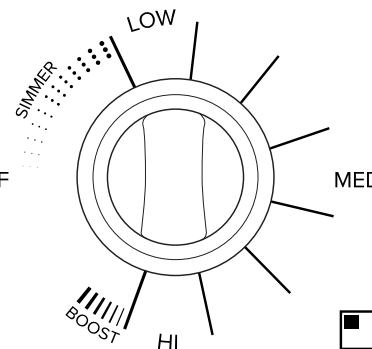

If you boost an element while using an element within the same power zone, the element not in boost (indicated by blue indicator light) will have the power reduced automatically.

Surface Operation

Surface Cooking Tips

- The minimum pot or pan diameter recommended is 5" (13 cm).

Note: If ALL elements are turned to HI for a long period of time, the internal temperature inside the cooktop may rise, causing the cooktop to turn off. Prior to shutting off, the indicator lights will flash faster and the power will be backed down on the element that is overheating.

Induction Power Sharing

The induction cooktop has 2 or 3 cooking zones based on the model consisting of 2 elements each. If using more than one cooking element on high power in the same zone, the maximum cooking power may be reduced. For best performance results, start cooking on only one element per shared zone. Once it has reached cooking temperature, start cooking on the second cooking zone.

Power sharing tips: Remember to select the power setting last for the cooking element you want to maintain at a full setting heat. To maintain full setting for two items, place items in non-shared zones.

Shared Zones

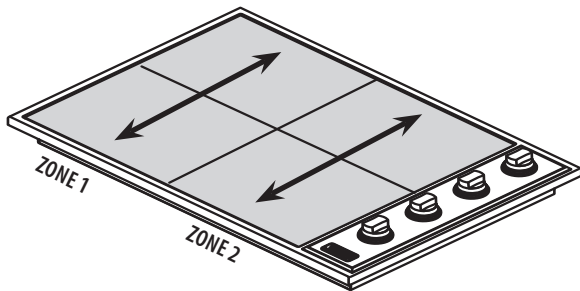

30" W. MODELS
2 SHARED COOKING ZONES

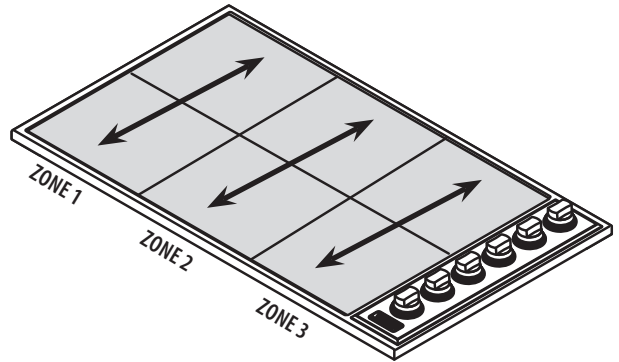

36" W. MODELS
3 SHARED COOKING ZONES

Surface Operation

Surface Cooking Guide - Suggested Heat Setting

Food	Start at Setting	Complete at Setting
Rice	Hi - cover, bring water to a boil	Lo - cover, finish timing according to directions
Chocolate	Lo - until melted	
Candy	Lo - cook	
Pudding, pie filling	Lo - cook according to directions	
Eggs - in shell fried poached	Hi - cover, bring to boil Hi - until pan is hot Hi - bring water to boil	OFF - let set to desired doneness Lo - Med, cook to desired doneness Lo - finish cooking
Sauces	Hi - melt fat	Lo-Med, finish cooking
Soups, stews	Hi - heat up liquid	Lo-Med, finish cooking
Vegetables	Hi - preheat skillet	Lo-Med, finish cooking until desired tenderness is reached
Breads - french toast, pancakes	Med-Hi, preheat skillet	Lo - cook to desired brownness
Cooked cereals, grits, oatmeal	Hi - cover, bring water to a boil	Lo-Med, add cereal and cook according to directions
Bacon, sausages	Hi - preheat skillet	Med - cook to desired doneness
Swiss steaks	Hi - melt fat, Med-Hi - to brown meat	Lo - add liquid, cover, simmer until tender
Chicken, fried	Hi - melt fat Med-Hi - to brown crust	Lo - cook until tender
Hamburgers, pork chops	Hi - preheat skillet	Med - to brown meat and cook to desired brownness
Pasta	Hi - bring salted water to a boil, add pasta slowly	Med - maintain boil until tender

Remember that induction cooking is instantaneous and boiling time is decreased when using the proper induction cookware.

Cleaning & Maintenance

Any piece of equipment works better and lasts longer when maintained properly and kept clean. Cooking equipment is no exception. Your cooktop must be kept clean. Make sure all controls are in the "OFF" position.

Glass Ceramic Top

Cleaning of glass ceramic tops is different from cleaning a standard porcelain finish. To maintain and protect the surface of your new glass ceramic top, follow these basic steps:

For normal, light soil:

1. Rub a few drops of a glass ceramic cleaning cream to the cool soiled area using a damp paper towel.
2. Wipe until all soil and cream are removed. Frequent cleaning leaves a protective coating which is essential in preventing scratches and abrasions.

For heavy, burned soil:

1. Rub a few drops of glass ceramic cleaning cream to the cool soiled area using a damp paper towel.
2. Carefully scrape remaining soil with a single-edged razor blade. Hold the blade at a 30° angle against the ceramic surface.
3. If any soil remains, repeat the steps above. For additional protection, after all soil has been removed, polish the entire surface with the cleaning cream.
4. Buff with a dry paper towel. As the cleaning cream cleans, it leaves a protective coating on the glass surface. This coating helps to prevent build-up of mineral deposits (water spots) and will make future cleaning easier.

Note: Dishwashing detergents remove this protective coating and therefore, make the glass ceramic top more susceptible to staining.

Cleaning Problems on Glass Ceramic Top

Problem	Cause	To Prevent	To Remove
Brown streaks and specks	Cleaning with sponge or cloth containing soil laden detergent water.	Use cleaning cream with clean damp paper towel.	Use a light application of cleaning cream with a clean damp paper towel.
Blackened burned on spots	Spatters or spillovers onto a hot cooking area or accidental melting of a plastic film, such as a bread bag.	Wipe all spillovers as soon as it is safe and DO NOT put plastic items on a warm cooking area.	Clean area with cleaning cream and a damp paper towel, non-abrasive nylon pad or scouring brush. If burn-on is not removed, cool cooktop, and carefully scrape area with a single-edged razor blade held at a 30° angle.
Fine brown/gray lines, fine scratches, or abrasions which have collected soil	Coarse particles (salt, sugar) can get caught on the bottom of cookware and become embedded into top. Use of abrasive cleaning materials. Scratches from rough ceramic glass, or ceramic coated cookware.	Wipe the bottom of cookware before cooking. Clean top daily with cleaning cream. DO NOT use ceramic or ceramic coated cookware.	Fine scratches are not removable but can be minimized by daily use of cleaning cream.
Smearing or streaking	Use of too much cleaning cream or use of a soiled dishcloth.	Use a small amount of cream. Rinse thoroughly before drying. Use only paper towels or nylon scrub pad or brush.	Dampen paper towel with a mixture of vinegar and water and wipe surface. Wipe area with damp paper towel or lint free cloth.

Cleaning & Maintenance

Cleaning Problems on Glass Ceramic Top (cont.)

Problem	Cause	To Prevent	To Remove
Metal markings (silver/gray marks)	Sliding or scraping metal cookware on glass top.	DO NOT slide metal objects across top.	Remove metal marks before the glass top is used again. Apply cleaning cream with a damp paper towel and scrub with a nylon scrub pad or brush. Rinse thoroughly and dry.
Metal markings (silver/gray marks)	Condensation from cooking may cause minerals found in water and acids to drip on to glass top and cause gray deposits (the spots are often so thin they appear to be in the glass top).	Make sure the bottom of cookware is dry before cooking. Daily use of cleaning cream will help keep top free from hard water mineral deposits and food discoloration.	Mix cleaning cream with water and apply a thick paste to stained area. Scrub vigorously. If stain is not removed, reapply cleaner and repeat process. Also try cleaning procedure for smearing and streaking.
Pitting or flaking	Boil over of sugar syrup on glass top. This can cause pitting if not removed immediately.	Watch sugar and syrups carefully to avoid boil overs.	Turn element to Off ; use several paper towels to wipe the spill immediately. Let glass top cool and carefully scrape off remainder of burn-off with a single-edged razor blade held at a 30° angle.

WARNING

A steam cleaner is not to be used for cleaning appliance.

Cooktop Surfaces

Several different finishes have been used in your cooktop. Cleaning instructions for each surface are given below. **NEVER USE AMMONIA, STEEL WOOL PADS OR ANY ABRASIVE CLOTHS AND MATERIALS SUCH AS CLEANSERS, OVEN CLEANERS, OR ABRASIVE POWDERS. THEY CAN PERMANENTLY DAMAGE YOUR COOKTOP.**

Control Panel

DO NOT use any cleaners containing ammonia, abrasives or stainless steel cleaners on any surface that contains graphics. These products could remove the graphics from the control panel. Apply hot, soapy water to a soft clean cloth. **DO NOT** spray liquids directly onto the control panel.

Control Knobs

MAKE SURE ALL CONTROL KNOBS POINT TO THE "OFF" POSITION BEFORE REMOVING. Pull the knobs straight off. Wash in detergent and warm water. Dry completely and replace by pushing firmly onto stem.

Stainless Steel Parts

All stainless steel body parts should be wiped regularly with hot, soapy water at the end of each cooling period and with a liquid cleaner designed for that material when soapy water will not do the job. **DO NOT** use steel wool, abrasive cloths, cleansers, or powders. If necessary, scrape stainless steel to remove encrusted materials, soak the area with hot towels to loosen the material, then use a wooden or nylon spatula or scraper. **DO NOT** use a metal knife, metal spatula, or any other metal tool to scrape stainless steel. **DO NOT** permit citrus or tomato juice to remain on stainless steel surface, as citric acid will permanently discolor stainless steel. Wipe up any spills immediately.

Service Information

If service is required, call your authorized service agency.

Have the following information readily available:

- Model number
- Serial number
- Date purchased
- Name of dealer from whom purchased

Clearly describe the problem that you are having. If you are unable to obtain the name of an authorized service agency, or if you continue to have service problems, contact Viking Range at (888) 845-4641 or write to:

**VIKING RANGE, LLC
PREFERRED SERVICE
111 Front Street
Greenwood, Mississippi 38930 USA**

The serial number and model number for your oven is located on the identification plate mounted on the top left side of the oven door opening under the control panel.

Record the information indicated below. You will need it if service is ever required. The model and serial number for your cooktop can be found by looking under the unit.

Model No. Serial No. _____

Date of Purchase _____ Date Installed _____

Dealer's Name _____

Address _____

If service requires installation of parts, use only authorized parts to insure protection under the warranty.

Keep this manual for future reference.

Warranty

BUILT-IN ELECTRIC COOKTOP WARRANTY TWO YEAR FULL WARRANTY

Built-in electric cooktops and all of their component parts, except as detailed below*, are warranted to be free from defective materials or workmanship in residential household use for a period of two (2) years from the date of original retail purchase. Viking Range, warrantor, agrees to repair or replace at its option, any part which fails or is found to be defective during the warranty period. Warranty service must be performed by a Viking Range LLC authorized service agency or representative.

***90 Day Cosmetic Warranty:** Products are warranted to be free from cosmetic defects in material or workmanship for a period of 90 days from the date of original retail purchase. This warranty covers manufacturing based defects only and does not cover issues resulting from handling or installation. Inspection of the product should be made at time of delivery. Any defects must be reported to the selling dealer within the 90 day period. Viking Range LLC uses the most up to date processes and the best materials available to produce all color finishes. However, slight color variation may be noticed because of the inherent differences in painted parts and porcelain parts as well as differences in product location and natural or artificial lighting. Warranty service must be performed by a Viking Range LLC authorized service agency or representative.

***90 Day Residential Plus:** Viking products are designed and certified for residential use only. They are not intended for use in commercial applications. Viking products should only be used in accordance to national and local codes. Viking is not responsible for property damage or injury resulting from use in a commercial application. To support the manufacturing quality of its appliance's Viking will provide a full 90 day warranty for products used in "Residential Plus" applications. This "Residential Plus" warranty applies to applications where use of the product extends beyond residential use but is in compliance with national and local code. In some jurisdictions these applications are zoned as residential. Examples of, but not limited to, such applications covered by this warranty are bed and breakfasts, fire stations, private clubs, churches, condominium/apartment common areas etc. Under this "Residential Plus" warranty, the product, its components and accessories are warranted to be free from defective material or workmanship for a period of ninety (90) days from the date of original retail purchase. Viking Range, LLC, warrantor, agrees to repair or replace, at its option, any part which fails or is found to be defective during the warranty period. This warranty covers parts and labor. This warranty excludes use of the product in all commercial locations such as restaurants, food service locations and institutional food service locations.

FIVE YEAR LIMITED WARRANTY

Any surface element or induction coil which fails due to defective materials or workmanship in normal residential use during the third thru the fifth year from the date of original retail purchase will be repaired or replaced free of charge for the part itself, with the owner paying all other costs, shipping, handling and labor. Aesthetic conditions such as corrosion, scratching, discoloration, carbon/food build up or similar blemishes due to normal wear and tear or improper use or lack of maintenance is excluded from this warranty.

WARRANTY TERMS

This warranty extends to the original retail purchaser of the product warranted hereunder and to each transferee owner of the product during the term of the original purchaser's warranty. The warranty is transferable by the original retail purchaser via home sale only. If a transferee owner is unable to provide proof of purchase from the original purchaser and the product has not been previously registered, the production date of the product, located in the serial number on the product, will serve as the effective warranty start date.

The activation date of the warranty begins from the date of original retail purchase. In the case of new product purchase via building development sales, activation begins from the earlier date of either certificate of occupancy or 24 months from date of manufacture. Note date of manufacture is identified by serial tag on product.

This warranty does not cover units purchased as b-stock, liquidation, salvage, seconds, refurbished, as-is, used products. This warranty shall apply to products purchased in the United States and Canada. Products must be purchased in the country where service is requested. Warranty service must be performed by a Viking Range LLC authorized service agency or representative. Warranty shall not apply to damage resulting from abuse, accident, natural disaster, loss of electrical power to the product for any reason, alteration, improper installation, improper operation, or repair service of the product by anyone other than a Viking Range LLC authorized service agency or representative. This warranty does not apply to commercial usage. Warrantor is not responsible for consequential or incidental damage whether arising out of breach of warranty, breach of contract or otherwise. Some jurisdictions do not allow the exclusion or limitation of incidental or consequential damages, so the above limitations do not apply to you. Owner shall be responsible for proper installation, providing normal care and maintenance, providing proof of purchase upon request, and making the product reasonably accessible for service. If the product or one of its component parts contains a defect or malfunction during the warranty period, after a reasonable number of attempts by the warrantor to remedy the defects or malfunctions, the owner is entitled to either a refund or replacement, at the warrantor's discretion of the product or its component part or parts. Warrantor's liability on any claim of any kind, with respect to the goods or services covered hereunder, shall in no case exceed the price of the goods or service or part thereof which gives rise to the claim.

WARRANTY SERVICE

Under the terms of this warranty, service must be performed by a Viking Range LLC authorized service agent or representative. Service will be provided during normal business hours. Labor performed at overtime or premium rates shall not be covered by the warranty. To obtain warranty service contact Viking Range LLC Customer Care at 1-888-845-4641. Please have model number, serial number, and date of original purchase available when calling. **IMPORTANT:** retain proof of original purchase to establish warranty period.

The return of the owner registration card is not a condition of warranty coverage. You should, however, return the owner registration card so Viking Range LLC can contact you should any question of safety arise which could affect you.

Any implied warranties of merchantability and fitness applicable to the above described burner assemblies, infrared rotisserie burners, grill grates, and stainless steel parts are limited in duration to the period of coverage of the applicable express written limited warranties set forth above. Some jurisdictions do not allow limitations on how long an implied warranty lasts, so the above limitations may not apply to you. This warranty gives you specific legal rights, and you may also have other rights which may vary from jurisdiction to jurisdiction.

Specifications subject to change without notice.

Viking Range, LLC
111 Front Street
Greenwood, Mississippi 38930 USA
(662) 455-1200

For product information, call 1-888-(845-4641)
or visit the Viking Web site at vikingrange.com