



# MICROWAVE OVEN HOOD COMBINATION USER INSTRUCTION

THANK YOU for purchasing this high-quality product. Register your microwave oven at [www.whirlpool.com](http://www.whirlpool.com).

For future reference, please make a note of your product model and serial number. These can be found on the label located on the microwave oven frame behind the top right side of the microwave oven door.

Model Number \_\_\_\_\_ Serial Number \_\_\_\_\_

## Table of Contents

<b>MICROWAVE OVEN SAFETY</b> .....	<b>2</b>
Electrical Requirements .....	4
<b>FEATURES</b> .....	<b>5</b>
Standby Mode.....	8
Auto Vent Fan.....	8
Control Lock.....	8
<b>MICROWAVE OVEN USE</b> .....	<b>9</b>
Food Characteristics.....	9
Cooking Guidelines.....	9
Cookware and Dinnerware .....	10
Aluminum Foil and Metal .....	10
Microwave Cooking Power.....	10
Defrost.....	11
Reheat .....	11
Cook.....	12
Popcorn.....	12
Soften/Melt.....	12
<b>MICROWAVE OVEN CARE</b> .....	<b>13</b>
General Cleaning.....	13
Installing / Replacing Grease Filter or Charcoal Filter .....	13
Replacing The Grease Filter For Recirculation Ventilation .....	14
Replacing The Charcoal Filter For Recirculation Ventilation .....	14
Replacing The Grease Filter For Wall and Roof Ventilation .....	14
Replacing The Cooktop Light .....	15
Replacing The Cavity Light .....	15
<b>TROUBLESHOOTING</b> .....	<b>16</b>
<b>ACCESSORIES/REPLACEMENT PARTS</b> .....	<b>16</b>



W11332391B

# MICROWAVE OVEN SAFETY

## Your safety and the safety of others are very important.

We have provided many important safety messages in this manual and on your appliance. Always read and obey all safety messages.



This is the safety alert symbol.

This symbol alerts you to potential hazards that can kill or hurt you and others.

All safety messages will follow the safety alert symbol and either the word "DANGER" or "WARNING."

These words mean:

**! DANGER**

You can be killed or seriously injured if you don't immediately follow instructions.

**! WARNING**

You can be killed or seriously injured if you don't follow instructions.

All safety messages will tell you what the potential hazard is, tell you how to reduce the chance of injury, and tell you what can happen if the instructions are not followed.

## IMPORTANT SAFETY INSTRUCTIONS

When using electrical appliances basic safety precautions should be followed, including the following:

**WARNING:** To reduce the risk of burns, electric shock, fire, injury to persons, or exposure to excessive microwave energy:

- Read all instructions before using the microwave oven.
- Read and follow the specific "PRECAUTIONS TO AVOID POSSIBLE EXPOSURE TO EXCESSIVE MICROWAVE ENERGY" found in this section.
- The microwave oven must be grounded. Connect only to properly grounded outlet. See "GROUNDING INSTRUCTIONS" found in this section and in the provided Installation Instructions.
- Install or locate the microwave oven only in accordance with the provided Installation Instructions.
- Some products such as whole eggs in the shell and sealed containers - for example, closed glass jars - are able to explode and should not be heated in the microwave oven.

## SAVE THESE INSTRUCTIONS

# IMPORTANT SAFETY INSTRUCTIONS

- Use the microwave oven only for its intended use as described in the manual. Do not use corrosive chemicals or vapors in the microwave oven. This type of oven is specifically designed to heat, cook, or dry food. It is not designed for industrial or laboratory use.
- As with any appliance, close supervision is necessary when used by children.
- Do not operate the microwave oven if it has a damaged cord or plug, if it is not working properly, or if it has been damaged or dropped.
- The microwave oven should be serviced only by qualified service personnel. Call an authorized service company for examination, repair, or adjustment.
- Do not cover or block any openings on the microwave oven.
- Do not store this microwave oven outdoors. Do not use the microwave oven near water - for example, near a kitchen sink, in a wet basement, near a swimming pool, or similar locations.
- Do not immerse cord or plug in water.
- Keep cord away from heated surfaces.
- Do not let cord hang over edge of table or counter.
- See door surface cleaning instructions in the "Microwave Oven Care" section.
- To reduce the risk of fire in the oven cavity:
  - Do not overcook food. Carefully attend the microwave oven when paper, plastic, or other combustible materials are placed inside the oven to facilitate cooking.
  - Remove wire twist-ties from paper or plastic bags before placing bags in oven.
  - If materials inside the oven ignite, keep oven door closed, turn oven off, and disconnect the power cord, or shut off power at the fuse or circuit breaker panel.
  - Do not use the cavity for storage purposes. Do not leave paper products, cooking utensils, or food in the cavity when not in use.
- Liquids, such as water, coffee, or tea are able to be overheated beyond the boiling point without appearing to be boiling. Visible bubbling or boiling when the container is removed from the microwave oven is not always present. THIS COULD RESULT IN VERY HOT LIQUIDS SUDDENLY BOILING OVER WHEN THE CONTAINER IS DISTURBED OR A SPOON OR OTHER UTENSIL IS INSERTED INTO THE LIQUID.
  - To reduce the risk of injury to persons:
    - Do not overheat the liquid.
    - Stir the liquid both before and halfway through heating it.
    - Do not use straight-sided containers with narrow necks.
    - After heating, allow the container to stand in the microwave oven for a short time before removing the container.
    - Use extreme care when inserting a spoon or other utensil into the container.
- Do not mount over a sink.
- Do not store anything directly on top of the microwave oven when the microwave oven is in operation.
- Clean Ventilating Hoods Frequently - Grease should not be allowed to accumulate on hood or filter.
- When flaming foods under the hood, turn the fan on.
- Suitable for use above both gas and electric cooking equipment.
- Intended to be used above ranges with maximum width of 36" (91.44 cm).
- Use care when cleaning the vent-hood filter. Corrosive cleaning agents, such as lye-based oven cleaners, may damage the filter.

## SAVE THESE INSTRUCTIONS

# PRECAUTIONS TO AVOID POSSIBLE EXPOSURE TO EXCESSIVE MICROWAVE ENERGY

- (a) Do not attempt to operate this oven with the door open since open-door operation can result in harmful exposure to microwave energy. It is important not to defeat or tamper with the safety interlocks.
- (b) Do not place any object between the oven front face and the door or allow soil or cleaner residue to accumulate on sealing surfaces.
- (c) Do not operate the oven if it is damaged. It is particularly important that the oven door close properly and that there is no damage to the:
  - (1) Door (bent),
  - (2) Hinges and latches (broken or loosened),
  - (3) Door seals and sealing surfaces.
- (d) The oven should not be adjusted or repaired by anyone except properly qualified service personnel.

## Electrical Requirements

### **⚠ WARNING**



#### **Electrical Shock Hazard**

**Plug into a grounded 3 prong outlet.**

**Do not remove ground prong.**

**Do not use an adapter.**

**Do not use an extension cord.**

**Failure to follow these instructions can result in death, fire, or electrical shock.**

Observe all governing codes and ordinances.

#### **Required:**

- A 120 V, 60 Hz, AC-only, 15 or 20 A electrical supply with a fuse or circuit breaker.

#### **Recommended:**

- A time-delay fuse or time-delay circuit breaker.
- A separate circuit serving only this microwave oven.

### **GROUNDING INSTRUCTIONS**

#### ■ **For all cord connected appliances:**

The microwave oven must be grounded. In the event of an electrical short circuit, grounding reduces the risk of electric shock by providing an escape wire for the electric current. The microwave oven is equipped with a cord having a grounding wire with a grounding plug. The plug must be plugged into an outlet that is properly installed and grounded.

**WARNING:** Improper use of the grounding plug can result in a risk of electric shock. Consult a qualified electrician or serviceman if the grounding instructions are not completely understood, or if doubt exists as to whether the microwave oven is properly grounded.

Do not use an extension cord. If the power supply cord is too short, have a qualified electrician or serviceman install an outlet near the microwave oven.

### **SAVE THESE INSTRUCTIONS**

This device complies with Part 18 of the FCC Rules.









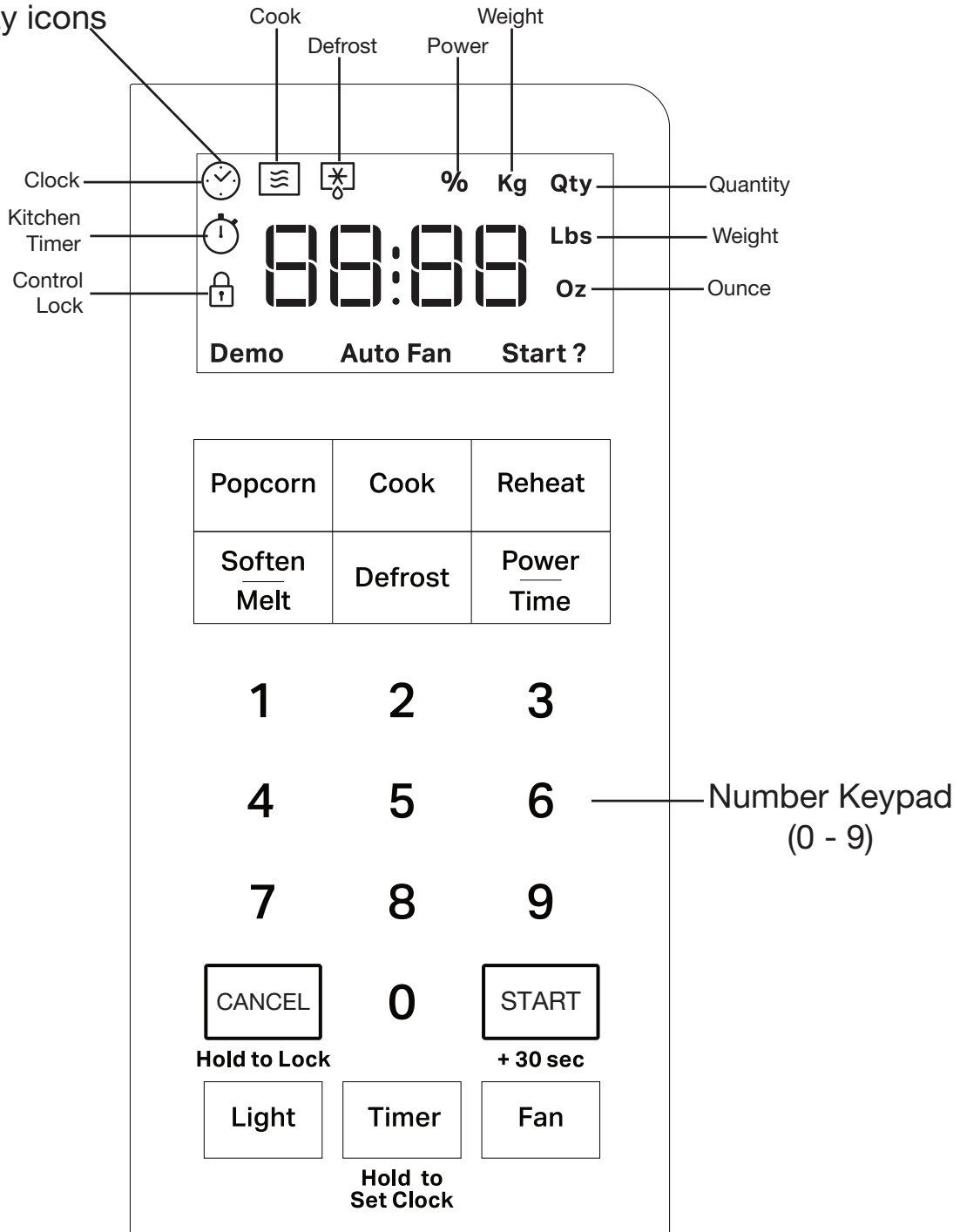

# FEATURES





## Feature Guide



This manual covers several models. Your model may have some or all of the items listed. Refer to this manual or the Product Help section of our website at [www.whirlpool.com](http://www.whirlpool.com) for more detailed instructions.

Display icons



Keypad	Feature	Instructions
 Timer Hold to Set Clock	Hold to Set the Clock	This microwave uses a 12 hour (1:00 - 12:59). To set the clock, following the instructions below: <ol style="list-style-type: none"> <li>1. Hold the TIMER button for about 3 seconds.</li> <li>2. A tone will sound and the 🕒 icon will appear on the display.</li> <li>3. Use the number keypads to set the clock.</li> <li>4. Press the START or the TIMER button to save the time.</li> </ol> <b>NOTE:</b> After power loss, it may be necessary to reset the clock.
 Timer Hold to Set Clock	Set Kitchen Timer	The kitchen timer functions independently of the microwave cooking functions, similar to a stop watch. To set the kitchen timer, following the instructions below: <ol style="list-style-type: none"> <li>1. Press TIMER button, the 🕒 icon will appear on the display.</li> <li>2. Press the number button to enter time up to 99 minutes and 59 seconds. The “Start?” icon will flash on the display.</li> <li>3. Press START button.</li> </ol> <b>NOTE:</b> When Kitchen Timer is running: The Add 30 Sec will not work. To reset the timer, press the number button, e.g. press the number button 1000, and the kitchen timer will reset to “10:00”. Press START button to start. To run manual cooking mode, press POWER/TIME button. To run an auto cooking mode, press POPCORN / COOK / REHEAT / DEFROST / SOFTEN or MELT button.
 START + 30 sec	Add 30 Seconds	The button  can be used in two ways: <ol style="list-style-type: none"> <li>1. To start the microwave by cooking for 30 seconds using the most recent power setting.</li> <li>2. To increase a cooking time using increments of 30 seconds. Each press adds 30 seconds or pressing and holding the START button will add more time automatically.</li> </ol> For example: To add 30 seconds of cook time, press the  button once. To add 1 minute of cooking time, press the  button twice. To add more time, press and hold  button until your preferred cook time is reached. <b>NOTE:</b> Holding the  button will add up to 10 minutes to the current time countdown. When 10 minutes has been added or the max time has been reached, invalid/retry tones will sound and the display will show the final time setting. If you want more time, you can release the keypad, then press and hold the START button again to add up to another 10 minutes.
 START + 30 sec	Start Function	Press the START button to start any cooking function. If cooking is interrupted by opening the door, touch the START button after the door is closed again to resume the cycle.
 CANCEL Hold to Lock	Microwave Oven Cancel	The CANCEL button stops any microwave oven function except for the clock and control lock. The microwave oven will also turn off when the door is opened. When the door is opened, the element(s) will turn off, but the microwave oven light will remain on. Close the door and touch the Start button to resume the preset cycle.
 CANCEL Hold to Lock	Activate Control Lock	Activate Control Lock to avoid an unintended start. To activate, press and hold the CANCEL button for 3 seconds until tone sounds and the CONTROL LOCKED icon appears on the display. Repeat to unlock control.
LIGHT	Turn on Hood Light	Press the LIGHT button to turn on the cooktop light. Press LIGHT repeatedly to adjust the light setting among HIGH-> LOW->OFF. The display will show “Hi”, “Lo” and “Off”. <b>NOTE:</b> The cooktop light can be operated independently from any cooking functions or the control lock status.
FAN	Turn on the Fan	Press the FAN button to turn the fan on or off. Press FAN repeatedly to change the fan setting among HIGH-> LOW->OFF. The display will show “Hi”, “Lo” and “Off”. <b>NOTE:</b> The hood fan can be operated independently from any cooking functions or the control lock status.

Keypad	Feature	Instructions
Number Key “4”	Set the Key Sound (Tones) On/Off	To enable or disable, press and hold number key “4” for about 5 seconds to disable key tones. Repeat to turn key tones back on. <b>NOTE:</b> <ul style="list-style-type: none"> <li>■ Only key entry tones are turned off. Other tones such as end of cycle tones are not affected.</li> <li>■ Tones can only be activated or deactivated when the microwave is idle.</li> </ul>
Number Key “3”	Activate Demo Mode	Demo mode shows the display and controls, including lights and fans, without using the magnetron, thus preventing microwave functions. To activate or deactivate Demo Mode in idle state. <b>To Activate/Deactivate:</b> Press and hold number key “3” for about 5 seconds.
Number Key “9”	Factory Reset	The microwave can be reset back to default state. To activate factory reset mode, press and hold number key “9” for about 10 seconds. <b>NOTE:</b> The microwave must be idle for factory reset.
Power/Time	Set Manual Cooking Power and Time	Press POWER/TIME to set manual power and cooking time. The default power level is 100%. Press any number keypad to change the power level. For example, to set the time to 2:30 in 90% power level. <ol style="list-style-type: none"> <li>1. Press POWER/TIME. The  icon will show on the display.</li> <li>2. Press keypad 9 to set the power level at 90%.</li> <li>3. Press POWER/TIME again. The  icon will show on the display.</li> <li>4. Use the number keypads to enter the cooking time length 2:30. The “Start?” icon will flash on the display.</li> <li>5. Press Start button. When the stop time is reached, the microwave oven will shut off automatically, and the end tone will sound.</li> </ol>
DEFROST	Automatic Defrost	The defrost function helps thaw frozen food. To defrost, follow the instructions below: <ol style="list-style-type: none"> <li>1. Press DEFROST. The icon  will show on the display.</li> <li>2. Use the number keypads to select a food category. See the DEFROST section in this guide for the food category or reference the sticker on the door of the microwave.</li> <li>3. Use the number keypads to enter the weight.</li> <li>4. Press Start button. The display will count down the defrost time. For better results, a preset standing time is included in the defrosting time. This may make the defrosting time seem longer than expected. When the stop time is reached, the microwave oven will shut off automatically, and the end tone will sound.</li> </ol>
REHEAT	Automatic Reheat	To reheat using preset functions, follow the instructions below: <ol style="list-style-type: none"> <li>1. Press REHEAT. The icon  will show on the display.</li> <li>2. Use the number keypads to select a food category. See the REHEAT section in this guide for the food category or reference the sticker on the door of the microwave.</li> <li>3. Use the number keypads to enter the quantity.</li> <li>4. Press START button. When the stop time is reached, the microwave oven will shut off automatically, and the end tone will sound.</li> </ol>
POPCORN	Popcorn	To use the popcorn preset, follow the instructions below: <ol style="list-style-type: none"> <li>1. Press POPCORN repeatedly to select the bag size. 3.0 oz is the default bag size. “Start?” will flash on the display.</li> <li>2. Press the START button. When the stop time is reached, the microwave oven will shut off automatically, and the end tone will sound.</li> </ol>

Keypad	Feature	Instructions
<b>SOFTEN/MELT</b>	Soften/Melt	<p>The SOFTEN/MELT function is used to soften or melt food. To use:</p> <ol style="list-style-type: none"> <li>1. Press SOFTEN/MELT. The  icon will show on the display.</li> <li>2. Use the number keypads to select a food category, see the SOFTEN/MELT section in this guide for the food category or reference the sticker on the door of the microwave.</li> <li>3. Use the number keypads to enter the quantity. "Start?" will flash on the display.</li> <li>4. Press START button. When the stop time is reached, the microwave oven will shut off automatically, and the end tone will sound.</li> </ol>
<b>COOK</b>	Auto Cook	<p>To use the auto cook presets, follow the instructions below:</p> <ol style="list-style-type: none"> <li>1. Press COOK. The  icon will show on the display.</li> <li>2. Use the number keypads to select a food category. See the COOK section in this guide for the food category or reference the sticker on the door of the microwave.</li> <li>3. Use the number keypads to enter the quantity. "Start?" will flash on the display.</li> <li>4. Press Start button. When the stop time is reached, the microwave oven will shut off automatically, and the end tone will sound.</li> </ol>

## Standby Mode

When no functions are being used, the microwave oven will switch to Standby Power mode and slightly dim the display brightness after about 2 minutes. Touch any key or open/close the door, and the display will return to the normal brightness.

## Auto Vent Fan

To keep the microwave oven from overheating, the auto vent fan will automatically turn on if the temperature from the range or cooktop below exceeds a certain temperature. When this occurs, the vent fan cannot be turned off and the fan speed cannot be changed. "AUTO FAN" will stay lit until the microwave oven cools.

## Control Lock

The Control Lock shuts down the control panel keypad to avoid unintended use of the microwave oven.

When the control is locked, only the fan and light will function.

**To Lock Control:** Touch CANCEL for approximately 3 seconds, until a tone sounds and a  icon appears on the display.

**To Unlock Control:** Repeat to unlock. A tone will sound and the  icon will be removed.



---

# MICROWAVE OVEN USE

A magnetron in the microwave oven produces microwaves which reflect off the metal floor, walls, and ceiling and pass through the turntable and appropriate cookware to the food. Microwaves are attracted to and absorbed by fat, sugar, and water molecules in the food, causing them to move, producing friction and heat which cooks the food.

- To avoid damage to the microwave oven, do not lean on or allow children to swing on the microwave oven door.
- To avoid damage to the microwave oven, do not operate microwave oven when it is empty, even with an empty container.
- The turntable must be in place and correct side up when the microwave oven is in use. Do not use if the turntable is chipped or broken.
- Baby bottles and baby food jars should not be heated in the microwave oven.
- Clothes, flowers, fruit, herbs, wood, gourds, and paper, including brown paper bags and newspaper, should not be dried in the microwave oven.
- Paraffin wax will not melt in the microwave oven because it does not absorb microwaves.
- Use oven mitts or pot holders when removing containers from the microwave oven.
- Do not overcook potatoes. At the end of the recommended cook time, potatoes should be slightly firm. Let potatoes stand for 5 minutes. They will finish cooking while standing.
- Do not cook or reheat whole eggs inside the shell. Steam buildup in whole eggs may cause them to burst. Cover poached eggs and allow a standing time.

---

## Food Characteristics

When the microwave oven is cooking, the amount, size and shape, starting temperature, composition and density of the food will affect the cooking results.

### Amount of Food

The more food that is heated at once, the longer the cook time that is needed. Check for doneness and add small increments of time, if necessary.

### Size and Shape

Smaller pieces of food will cook more quickly than larger pieces, and uniformly shaped food cooks more evenly than irregularly shaped food.

### Starting Temperature

Room temperature foods will heat faster than refrigerated foods, and refrigerated foods will heat faster than frozen foods.

### Composition and Density

Foods high in fat and sugar will reach a higher temperature and will heat faster than other foods. Heavy, dense foods, such as meat and potatoes, require a longer cook time than the same size of a light, porous food, such as cake.

---

## Cooking Guidelines

### Covering

Covering food helps retain moisture, shorten cook time, and reduce spattering. Use the lid supplied with cookware. If a lid is not available, wax paper, paper towels, or plastic wrap approved for microwave ovens may be used. Plastic wrap should be turned back at one corner to provide an opening to vent steam. Condensation on the door and cavity surfaces is normal during heavy cooking.

### Stirring and Turning

Stirring and turning redistributes heat evenly to avoid overcooking the outer edges of food. Stir from outside to center. If possible, turn food over from bottom to top.

### Arranging

If heating irregularly shaped or different-sized foods, arrange the thinner parts and smaller-sized items toward the center. If cooking several items of the same size and shape, place them in a ring pattern, leaving the center of the ring empty.

### Piercing

Before heating, use a fork or small knife to pierce or prick foods that have a skin or membrane, such as potatoes, egg yolks, chicken livers, hot dogs, and sausage. Prick in several places to allow steam to vent.

## Shielding

Use small, flat pieces of aluminum foil to shield the thin pieces of irregularly shaped foods, bones, and foods such as chicken wings, leg tips, and fish tails. See the “Aluminum Foil and Metal” section first.

## Standing Time

Food will continue to cook by the natural conduction of heat, even after the microwave cooking cycle ends. The length of standing time depends on the volume and density of the food.

## Cookware and Dinnerware

Cookware and dinnerware must fit on the turntable. Always use oven mitts or pot holders when handling because any dish may become hot from heat transferred from the food. Do not use cookware and dinnerware with gold or silver trim. Use the following chart as a guide, then test before using.

Material	Recommendations
<b>Aluminum Foil, Metal</b>	See the “Aluminum Foil and Metal” section.
<b>Browning Dish</b>	Bottom must be at least 3/16" (5 mm) above the turntable. Follow manufacturer’s recommendations.
<b>Ceramic Glass, Glass</b>	Acceptable for use.
<b>China, Earthenware</b>	Follow manufacturer’s recommendations.
<b>Melamine</b>	Follow manufacturer’s recommendations.
<b>Paper:</b> Towels, Dinnerware, Napkins	Use non-recycled and those approved by the manufacturer for microwave oven use.
<b>Plastic:</b> Wraps, Bags, Covers, Dinnerware, Containers	Use those approved by the manufacturer for microwave oven use.
<b>Pottery and Clay</b>	Follow manufacturer’s recommendations.
<b>Silicone Bakeware</b>	Follow manufacturer’s recommendations.
<b>Straw, Wicker, Wooden Containers</b>	Do not use in microwave oven.
<b>Styrofoam®†</b>	Do not use in microwave oven.
<b>Wax Paper</b>	Acceptable for use.

### To Test Cookware or Dinnerware for Microwave Use:

1. Place cookware or dinnerware in microwave oven with 1 cup (250 mL) of water beside it.
2. Cook at 100% cooking power for 1 minute.

Do not use cookware or dinnerware if it becomes hot and the water stays cool.

## Aluminum Foil and Metal

Always use oven mitts or pot holders when removing dishes from the microwave oven.

Aluminum foil and some metal can be used in the microwave oven. If not used properly, arcing (a blue flash of light) can occur and cause damage to the microwave oven.

## OK for Use

Racks and bakeware supplied with the microwave oven (on some models), aluminum foil for shielding, and approved meat thermometers may be used with the following guidelines:

- To avoid damage to the microwave oven, do not allow aluminum foil or metal to touch the inside cavity walls, ceiling, or floor.
- Always use the turntable.
- To avoid damage to the microwave oven, do not allow contact with another metal object during microwave cooking.

## Do Not Use

Metal cookware and bakeware, gold, silver, pewter, non-approved meat thermometers, skewers, twist ties, foil liners, such as sandwich wrappers, staples, and objects with gold or silver trim or a metallic glaze, should not be used in the microwave oven.

Metal bakeware may be used only during convection (bake) cycles. Use ovenproof, microwave-safe cookware for all other convection and combination cooking.

## Microwave Cooking Power

Many recipes for microwave cooking specify which cooking power to use by percent, name, or number. For example, 70%=Medium-High=7.

Use the following chart as a general guide for the suggested cooking power of specific foods.

### MICROWAVE COOKING POWER CHART

Percent/ Name	Number	Use
<b>100%, High (default setting)</b>	10	Quick-heating convenience foods and foods with high water content, such as soups, beverages, and most vegetables.
<b>90%</b>	9	Cooking small, tender pieces of meat, ground meat, poultry pieces, and fish fillets. Heating cream soups.
<b>80%</b>	8	Heating rice, pasta, or casseroles. Cooking and heating foods that need a cook power lower than high, for example, whole fish and meat loaf.
<b>70%, Medium-High</b>	7	Reheating a single serving of food.
<b>60%</b>	6	Cooking sensitive foods such as cheese and egg dishes, pudding, and custards. Cooking non-stirtable casseroles, such as lasagna.
<b>50%, Medium</b>	5	Cooking ham, whole poultry, and pot roasts. Simmering stews.
<b>40%</b>	4	Melting chocolate. Heating bread, rolls, and pastries.
<b>30%, Medium-Low, Defrost</b>	3	Defrosting bread, fish, meats, poultry, and precooked foods.
<b>20%</b>	2	Softening butter, cheese, and ice cream.
<b>10%, Low</b>	1	Taking chill out of fruit.

†Styrofoam® is a registered trademark of The Dow Chemical Company.

## Defrost

- For optimal results, food should be 0°F (-18°C) or colder when defrosting.
- Unwrap foods and remove lids (from fruit juice) before defrosting.
- Shallow packages will defrost more quickly than deep blocks.
- Separate food pieces as soon as possible during or at the end of the cycle for more even defrosting.
- Foods left outside the freezer for more than 20 minutes or frozen ready-made food should not be defrosted using the Defrost feature but should be defrosted manually.
- Use small pieces of aluminum foil to shield parts of food such as chicken wings, leg tips, and fish tails. See the “Aluminum Foil and Metal” section first.
- Times and cooking powers have been preset for defrosting a number of food types.

Item	Food Category	Weight
1	<b>Meats*</b>	0.2 to 6.6 lbs (90 g to 3 kg)
2	<b>Poultry*</b>	0.2 to 6.6 lbs (90 g to 3 kg)
3	<b>Fish*</b>	0.2 to 4.4 lbs (90 g to 2 kg)
4	<b>Quick</b>	1.0 lb only (450 g)

\* See the Defrost Preparation Chart at end of the “Defrost” section for cuts, sizes, and instructions.

Use the following chart as a guide when defrosting meat, poultry, or fish.

### DEFROST PREPARATION CHART

#### MEAT

<b>Beef:</b> ground, steaks, roast, stew	The narrow or fatty areas of irregular-shaped cuts should be shielded with foil before defrosting.
<b>Lamb:</b> stew and chops	Do not defrost less than 1/4 lb (113 g) or two 4 oz (113 g) patties.
<b>Pork:</b> chops, ribs, roasts, sausage	Place all meats in a microwave-safe container.

#### POULTRY

<b>Chicken:</b> whole and cut up	Place in a microwave safe container, chicken breast side up.
<b>Cornish hens</b>	Remove giblets from whole chicken.
<b>Turkey:</b> breast	

#### FISH

<b>Fillets, Steaks, Whole, Shellfish</b>	Place in a microwave-safe container.
--	--------------------------------------

## Reheat

Times and cooking powers have been preset for reheating a number of food types.

Use the following chart as a guide.

Item	Food Category	Quantity
1	<b>Beverage</b> Do not cover.	1-2 cups (250 mL-500 mL)
2	<b>Casserole</b> Place in microwave-safe container. Cover with plastic wrap and vent. Stir and let stand 2-3 minutes after reheating.	1-4 cups (250 mL-1 L)
3	<b>Dinner plate</b> Place food on plate. Cover with plastic wrap and vent. Let stand 2-3 minutes after reheating.	1 plate, about 8-16 oz (227-454 g)
4	<b>Pizza</b> Place on paper towel lined microwave-safe plate.	1-3 slice, 4 oz (113 g) each
5	<b>Soup/Sauce</b> Place in microwave-safe container. Cover with plastic wrap and vent. Stir and let stand 2-3 minutes after reheating.	1-4 cups (250 mL-1 L)

## Cook

Item	Food Category	Quantity
1	<b>Bacon</b> Average thickness: Follow directions on package. For best results, place bacon on microwave-safe bacon rack.	1-6 slices
2	<b>Canned Vegetable</b> Place in microwave-safe container. Cover with plastic wrap, and vent. Stir and let stand 2-3 minutes after cooking.	1, 2, 3 or 4 cups (250, 500, 750 mL or 1 L)
3	<b>Fresh Vegetable</b> Place in microwave-safe container and add 2-4 tbs water. Cover with plastic wrap and vent. Stir and let stand 2-3 minutes after cooking.	1-4 cups (250 mL-1 L)
4	<b>Frozen Vegetable</b> Place in microwave-safe container and add 2-4 tbs water. Cover with plastic wrap and vent. Stir and let stand 2-3 minutes after cooking.	1-4 cups (250 mL-1 L)
5	<b>Small Potatoes</b> Pierce each potato several times with a fork. Place on paper towel, around turntable edges, at least 1" (2.5 cm) apart. Let stand 5 minutes after cooking.	1-4 pieces, 4-7 oz (113-198 g)
6	<b>Large Potatoes</b> Pierce each potato several times with a fork. Place on paper towel, around turntable edges, at least 1" (2.5 cm) apart. Let stand 5 minutes after cooking.	1-4 pieces, 8-10 oz (227-283 g)
7	<b>Rice</b> Follow measurements on package for ingredient amounts. Place rice and liquid in microwave-safe dish. Cover with loose fitting lid. Let stand 5 minutes after cooking, or until liquid is absorbed. Stir.	0.5, 1.0, 1.5, 2.0 cups (125, 250, 375, 500 mL) (dry, white long grain)

## Popcorn

3.0 or 3.5 oz bags.

- Do not use regular paper bags or glassware.
- Pop only one package of popcorn at a time.
- Follow manufacturer's instructions when using a microwave popcorn popper.
- Listen for popping to slow to one pop every 1 or 2 seconds, and then stop the cycle. Do not repop unpopped kernels.
- For best results, use fresh bags of popcorn.
- Cooking results may vary by brand and fat content.

**NOTE:** Follow the instructions provided by the microwave popcorn manufacturer.

## Soften/Melt

Soften and Melt functions may be used to soften or melt your food. Times and cooking powers have been preset for a number of food types. Use the following chart as a guide.

Item	Food Category	Quantity	Preparation
1	<b>Soften Butter</b>	0.5, 1.0, 1.5, 2.0 sticks	Unwrap and place in microwave-safe container.
2	<b>Soften Ice Cream</b>	16, 32, or 64 oz (473, 946 or 1893 mL)	Place ice cream container on turntable.
3	<b>Soften Cream Cheese</b>	8 oz (227 g)	Unwrap and place in microwave-safe container.
4	<b>Soften Frozen Juice</b>	12 oz (340 g)	Remove lid.
5	<b>Melt Butter</b>	0.5, 1.0, 1.5, 2.0 sticks	Unwrap and place in microwave-safe container.
6	<b>Melt Chocolate</b>	4, 6, 8 or 12 oz (113, 170, 227 or 340 g)	Cut squares into small pieces or use chips. Place in microwave-safe container.
7	<b>Melt Cheese</b>	8 or 16 oz (227 or 454 g)	Cut into small pieces and place in microwave-safe container.
8	<b>Melt Marshmallows</b>	5 or 10 oz (142 or 283 g)	Place in microwave-safe container.

# MICROWAVE OVEN CARE

## General Cleaning

**IMPORTANT:** Before cleaning, make sure all controls are off and the microwave oven is cool. Always follow label instructions on cleaning products.

Soap, water, and a soft cloth or sponge are suggested first, unless otherwise noted.

### STAINLESS STEEL (on some models)

**NOTE:** To avoid damage to stainless steel surfaces, do not use soap filled scouring pads, abrasive cleaners, cooktop polishing creme, steel-wool pads, gritty washcloths, or abrasive paper towels. Damage may occur to stainless steel surfaces, even with one-time or limited use.

Rub in direction of grain to avoid damaging.

#### Cleaning Method:

- Affresh® Stainless Steel Cleaners (not included): See the “Accessories” section.
- Vinegar for hard water spots.

### MICROWAVE OVEN DOOR EXTERIOR

#### Cleaning Method:

- Glass cleaner and a soft cloth or sponge: Apply glass cleaner to soft cloth or sponge, not directly on panel.

### MICROWAVE OVEN CAVITY

To avoid damage to microwave oven cavity, do not use soap-filled scouring pads, abrasive cleaners, steel-wool pads, gritty washcloths, or some paper towels.

On stainless steel models, rub in direction of grain to avoid damaging the unit.

The area where the microwave oven door and frame touch when closed should be kept clean.

#### Cleaning Method:

##### Average soil

- Mild, nonabrasive soaps and detergents: Rinse with clean water and dry with soft, lint-free cloth.

##### Heavy soil

- Mild, nonabrasive soaps and detergents: Heat 1 cup (250 mL) of water for 2 to 5 minutes in microwave oven. Steam will soften soil. Rinse with clean water and dry with soft, lint-free cloth.

##### Odors

- Lemon juice or vinegar: Heat 1 cup (250 mL) of water with 1 tbs (15 mL) of either lemon juice or vinegar for 2 to 5 minutes in microwave oven.

### TURNTABLE

Replace turntable immediately after cleaning. Do not operate the microwave oven without the turntable in place.

#### Cleaning Method:

- Mild soap and water
- Dishwasher

### GREASE FILTERS

- Mild soap, water, and dishwasher clean is not recommended.

### TURNTABLE SUPPORT AND ROLLERS, HUB

- Mild soap and water or dishwasher

### NONSTICK CAVITY COATING (on some models)

- To avoid damage to the microwave oven cavity, do not use metal or sharp utensils or scrapers or any type of abrasive cleanser or scrubbers.

## Installing / Replacing Grease Filter or Charcoal Filter

### For recirculation only:

Do not operate the microwave oven without the charcoal filter in place.

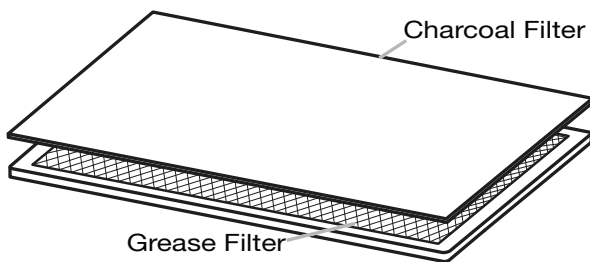

### For Wall and Roof Ventilation:

To ensure good performance of airflow, remove the Charcoal Filter from the bottom plate before operating the microwave oven.

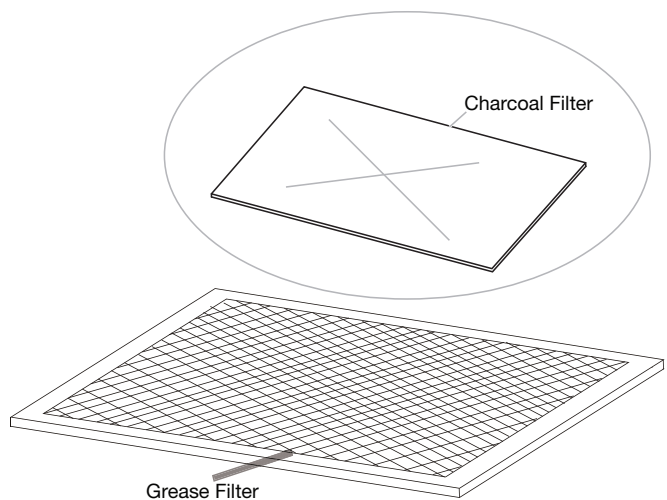

# MICROWAVE OVEN CARE

## Replacing The Grease Filter For Recirculation Ventilation

### Grease Filter:

The grease filter is located on the underside of the microwave oven. The grease filter should be removed and cleaned at least once a month.

1. To remove the grease filter, use a Phillips screwdriver to remove the screw on the grease filter.

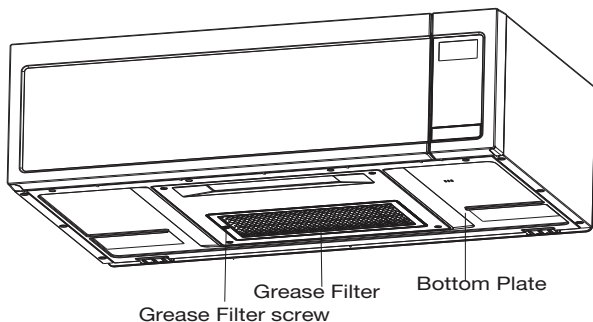

2. Hold the left side of the grease filter, swing it to the right position, and remove it from the slotted area.

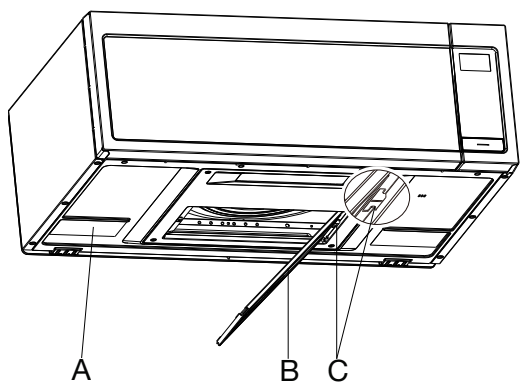

- A. Bottom Plate
- B. Grease Filter and Charcoal Filter
- C. Slotted-Area

3. Separate the grease filter from the charcoal filter.

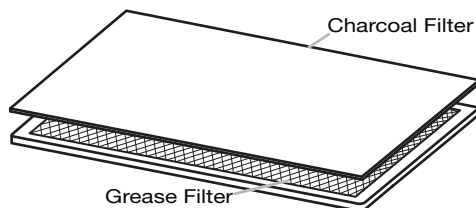

4. Clean the grease filter monthly, or replace with new grease filter if necessary.
5. Reattach the grease filter to the charcoal filter.
6. Put the grease filter and charcoal filter back to the bottom plate slotted area.
7. Secure the grease filter and charcoal filter back to the bottom plate with the grease filter screw.

## Replacing The Charcoal Filter For Recirculation Ventilation

### Charcoal Filter:

The charcoal filter is behind the grease filter at the bottom of the microwave oven. The charcoal filter cannot be cleaned and should be replaced about every 6 months.

Repeat steps 1 to 3 from the "Replacing Grease Filter For Recirculation Ventilation".

1. Replace the old charcoal filter with a new charcoal filter. Attach it to the grease filter.
2. Put the grease filter and the charcoal filter back to the bottom plate slotted area.
3. Secure the grease filter and the charcoal filter back to the bottom plate with the grease filter screw.

## Replacing The Grease Filter For Wall and Roof Ventilation

**Grease Filter:** The grease filter is located on the underside of the microwave oven. The grease filter should be removed and cleaned at least once a month.

1. To remove the grease filter. Use a Phillips screwdriver to remove the screw on the grease filter.

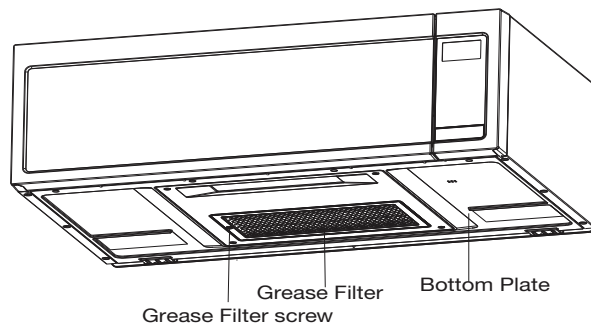

2. Hold the left side of the grease filter, swing it to the right position, and remove it from the slotted area.

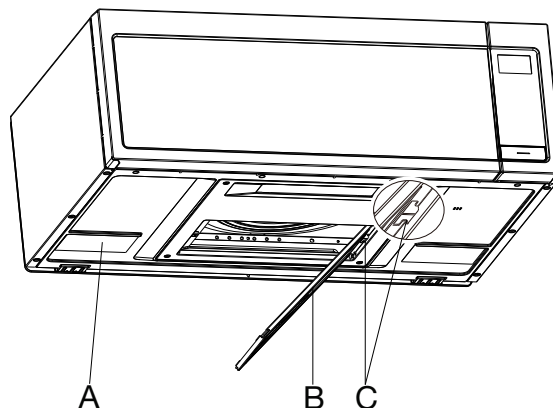

- A. Bottom Plate
- B. Grease Filter
- C. Slotted-Area

3. Clean the grease filter monthly, or replace it with new grease filter if necessary.
4. Reattach the grease filter to bottom plate.
5. Secure the grease filter back to the bottom plate with the grease filter screw.

# MICROWAVE OVEN CARE

## Replacing The Cooktop Light

**Cooktop Light:** The Cooktop Light is located on the underside of microwave oven, behind the bottom light cover. It is replaceable.

To replace the Cooktop Light refer the following steps:

1. Use a Phillips screwdriver to remove the 4 screws from the bottom light cover.

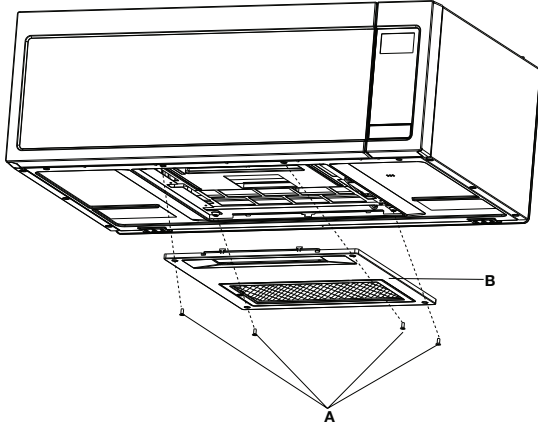

A. Screws  
B. Bottom Light Cover

2. Push the 2 hooks backward and remove the LED.

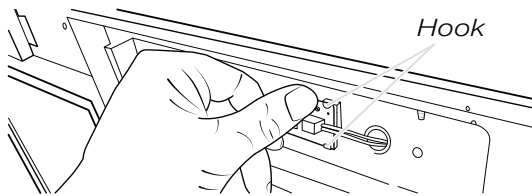

3. Unplug the terminal from the LED board.

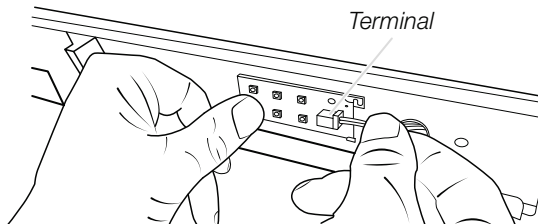

4. Replace the old LED with a new LED and press it back between two hooks and plug it into the terminal.

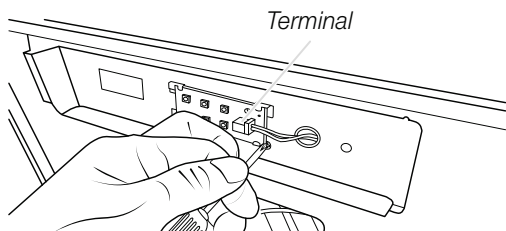

5. Use a Phillips screwdriver to reattach the 4 screws back to the bottom light cover.

## Replacing The Cavity Light

**Cavity Light:** The Cavity Light is located at the top front of the microwave oven, under the cover and is replaceable.

To replace the cavity light refer the following steps.

1. Use a Phillips screwdriver to remove the second left vent top cover screw from the top front of the microwave oven.

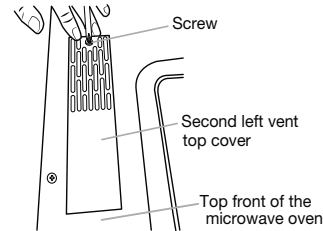

2. Remove the second left top cover.

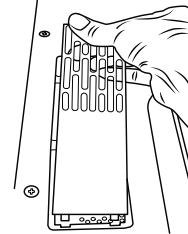

3. Pull out the halogen light from the light holder.
4. Insert the replacement halogen bulb.

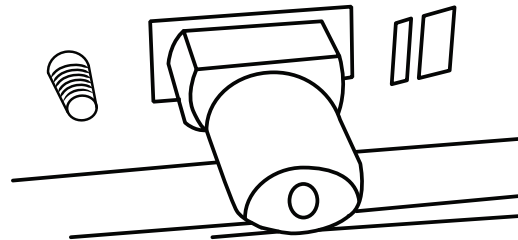

5. Reattach the second left top vent cover with the screw removed in step 1.

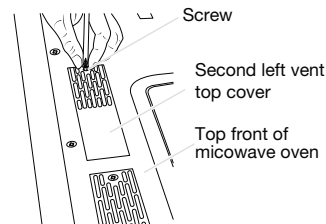

---

# TROUBLESHOOTING

First try the solutions suggested here. If you need further assistance or more recommendations that may help you avoid a service call, please visit the “Troubleshooting” section at <https://www.whirlpool.com/owners> for Troubleshooting help. In Canada, visit <https://www.whirlpool.ca/owners>. You can also reach us by phone or mail using the information below:

USA: 1-866-698-2538  
Canada: 1-800-807-6777  
Whirlpool Customer Service  
553 Benson Road  
Benton Harbor, MI 49022

---

If you experience	Recommended Solutions
<b>Microwave oven will not operate</b>	<p><b>Check the following:</b></p> <ul style="list-style-type: none"><li>■ <b>Household fuse or circuit breaker:</b> If a household fuse has blown or a circuit breaker has tripped, replace the fuse or reset the circuit breaker. If the problem continues, call an electrician.</li><li>■ <b>Magnetron:</b> Try to heat 1 cup (250 mL) of cold water for 2 minutes at 100% cooking power. If water does not heat, try the steps in the bullets below. If microwave oven still does not operate, call for service.</li><li>■ <b>Door:</b> Firmly close door. On some models, if a packaging spacer is attached to inside of the door, remove it, then firmly close door. If a message about the door appears in the display, the door has been closed for 5 minutes or more without the microwave oven being started. This occurs to avoid unintended starting of the microwave oven. Open and close the door, then start the cycle.</li><li>■ <b>Control:</b> Make sure control is set properly. Make sure Control Lock is off. Make sure Demo mode (on some models) is off.</li></ul>
<b>Arcing in the microwave oven.</b>	<p><b>Check the following:</b></p> <ul style="list-style-type: none"><li>■ <b>Soil buildup:</b> Soil buildup on cavity walls, microwave inlet cover, cooking rack supports, and area where the door touches the frame can cause arcing. See “General Cleaning” in the “Microwave Oven Care” section.</li></ul>
<b>Turntable alternates rotation directions</b>	<ul style="list-style-type: none"><li>■ This is normal and depends on motor rotation at the beginning of the cycle.</li></ul>
<b>Display shows messages</b>	<ul style="list-style-type: none"><li>■ “:.” means there has been a power failure. Reset the clock.</li><li>■ A letter followed by a number is an error indicator. Call for assistance.</li></ul>
<b>Fan running during cooktop usage</b>	<p>This is normal. The microwave oven’s vent fan automatically comes on during microwave oven operation to cool the microwave oven. It may also automatically come on and cycle on and off to cool the microwave oven’s controls while the cooktop below is being used.</p>
<b>Radio, TV, or cordless phone interference</b>	<p><b>Check the following:</b></p> <ul style="list-style-type: none"><li>■ <b>Proximity:</b> Move the receiver away from the microwave oven, or adjust the radio or TV antenna.</li><li>■ <b>Soil:</b> Make sure the microwave oven door and sealing surfaces are clean.</li><li>■ <b>Frequency:</b> Some 2.4 GHz based cordless phones and home wireless networks may experience static or noise while microwave oven is on. Use a corded phone, a different frequency cordless phone, or avoid using these items during microwave oven operation.</li></ul>

---

## ACCESSORIES/REPLACEMENT PARTS

For accessories in the U.S.A., you can visit our website at [www.whirlpool.com](http://www.whirlpool.com) or call us at **1-866-698-2538**. In Canada, visit <https://www.whirlpool.ca/owner> or call us at **1-800-807-6777**.

### Cleaning Supplies

- Affresh® Stainless Steel Cleaning Mousse
- Affresh® Stainless Steel Cleaning Brightener
- Affresh® Stainless Steel Cleaning Wipes
- Affresh® Stainless Steel Cleaning Spray
- Charcoal Filter  
Order Part Number W11330263
- Grease Filter  
Order Part Number W11371546
- Replacement Cooktop Light  
Order Part Number W11384716
- Replacement Cavity Light  
Order Part Number W10709921