

MICROWAVE OVEN HOOD COMBINATION BUMP OUT KIT INSTALLATION INSTRUCTIONS

If cabinets are deeper than 13" (33 cm) but no more than 16" (40.6 cm), use the bump out mounting kit to replace the mounting bracket that comes with your unit. These installation instructions are only for the Bump out mounting kit, for full microwave hood combination installation, please refer to the owner manual that came with the microwave hood combination.

MICROWAVE OVEN SAFETY

Your safety and the safety of others are very important.

We have provided many important safety messages in this manual and on your appliance. Always read and obey all safety messages.



This is the safety alert symbol.

This symbol alerts you to potential hazards that can kill or hurt you and others.

All safety messages will follow the safety alert symbol and either the word "DANGER" or "WARNING."

These words mean:

⚠ DANGER

You can be killed or seriously injured if you don't immediately follow instructions.

⚠ WARNING

You can be killed or seriously injured if you don't follow instructions.

All safety messages will tell you what the potential hazard is, tell you how to reduce the chance of injury, and tell you what can happen if the instructions are not followed.



W11646788B

INSTALLATION INSTRUCTIONS REQUIREMENTS

Tools and Parts







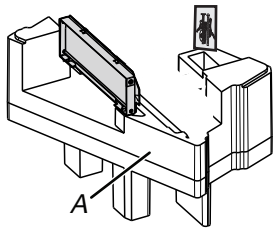

Tools Needed

- Measuring tape
- Pencil
- Scissors
- Masking tape or thumbtacks
- Drill
- No. 2 Phillips screwdriver
- Stud finder
- No. 3 Phillips screwdriver for 1/4 - 20 x 3" (76 mm) bolts
- 3/16" (5 mm), 3/8" (10 mm), 5/8" (16 mm) drill bits
- 3/4" (19 mm) hole saw
- Keyhole saw
- Diagonal wire cutting pliers
- 7/16" (11 mm) socket wrench (or box wrench) for 1/4" x 2" (6.4 mm x 51 mm) lag screws
- 1 1/2" (38 mm) diameter hole drill bit for wood or metal cabinet
- Caulking gun and weatherproof caulking compound
- Duct tape

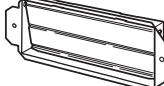

Materials Needed

- Standard fittings for wall or roof venting. See the "Venting Design Specifications" section.

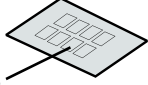
Parts Needed (Provided in the Microwave Oven)

Part	Drawing	Description	Quantity	Where can find?
Screw Pack		3/16 - 24 x 3" round-head bolts	2	 A. Inner Foam in the cavity
		1/4 - 20 x 3" flat-head bolts	2	
		Washers	2	
		3/16" toggle nuts	2	
		1/4" x 2" lag screws	4	
		#6 x 3/8" Sheet metal screws	2	
		Power supply cord bushing	1	
Damper		Damper for wall or roof venting	1	
Spacer		Spacer (L*W*T: 40*10*1.6 mm)	16	 B. Inside the Literature pack

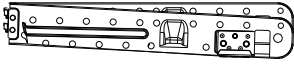
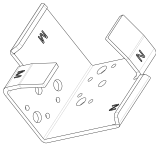
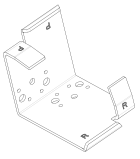
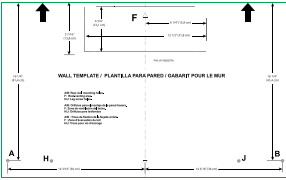
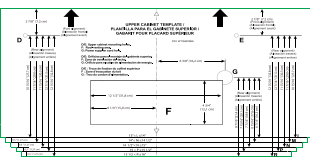
Parts Needed (Provided in the Bump Out Mounting Kit)

Part	Drawing	Description	Quantity	Where can find?
13" ~ 14" L Bracket Bump Out Mounting Plate Folded		Folded Mounting plate with L bracket unfold before installation	1	Bump out mounting kit
14" ~ 15" M and N Bracket		M side for 14" (35.6 cm) ~ 14½" (36.8 cm) depth N side for 14½" (36.8 cm) ~ 15" (38.1 cm) depth	2	
15" ~ 16" P and R Bracket		P side for 15" (38.1 cm) ~ 15½" (39.4 cm) depth R side for 15½" (39.4 cm) ~ 16" (40.6 cm) depth	2	
Wall Template		Wall Template	1	
Upper Cabinet Template		Upper cabinet template for 13" (33 cm) to 16" (40.6 cm) depth cabinet	1	
Bump Out Kit Installation Instruction		Installation Instruction	1	

Keep the mounting plate and cardboard template provided with the microwave oven for future use if necessary.

Location Requirements

Check the opening where the microwave oven will be installed. The location must provide:

- Minimum installation dimensions. See the "Installation Dimensions" illustration.
- Minimum one 2" x 4" (51 x 102 mm) wood wall stud and minimum 3/8" (10 mm) thickness drywall or plaster/lath within cabinet opening.
- Support for weight of 150 lbs (68 kg) which includes microwave oven and items placed inside the microwave oven and upper cabinet.
- Grounded electrical outlet inside upper cabinet. See the "Electrical Requirements" section.

NOTE: Some cabinet and building materials are not designed to withstand the heat produced by the microwave oven for cooking. Check with your builder or cabinet supplier to make sure that the materials used will not discolor, delaminate, or sustain other damages.

Special Requirements

For Wall Venting Installation Only:

- Cutout must be free of any obstructions so that the vent fit properly and the damper blade opens freely and fully.

For Roof Venting Installation Only:

- If you are using a rectangular-to-round transition piece, the 3" (76 mm) clearance needs to exist above the microwave oven so that the damper blade can open freely and fully. See "Rectangular to Round Transition" illustration in the "Venting Design Specifications" section on the Owner Manual on the product.

Installation Dimensions

NOTE: The grounded 3 prong outlet must be inside the upper cabinet. See the "Electrical Requirements" section on the Owner Manual on the product.

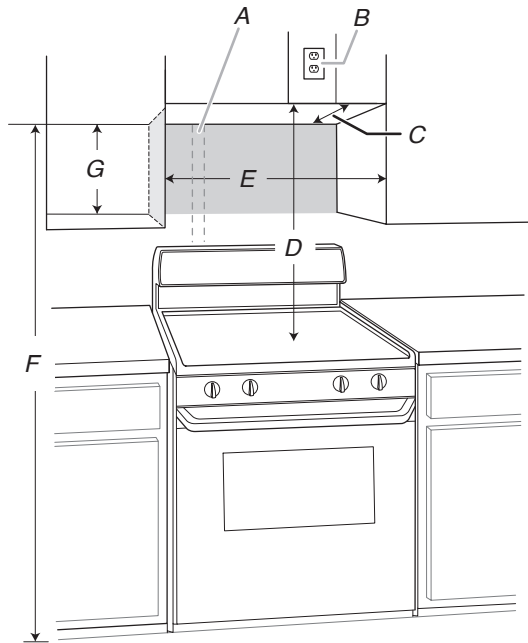

- A. 2" x 4" (51 mm x 102 mm) wall stud
- B. Grounded 3 prong outlet
- C. Upper cabinet depth (with door) 13" (33 cm) to 16" (40.6 cm)***
- D. 36" (91.4 cm) recommended* 30" (76.2 cm) typical**
- E. 30" (76.2 cm) minimum
- F. 72" (182.8 cm) recommended 66" (167.6 cm) minimum
- G. Flat back surface 18 1/4" (46.3 cm) minimum

Exact dimensions may vary depending on type of range/cooktop below.

*36" (91.4 cm) is recommended for 72" (182.8 cm) installation height.

**30" (76.2 cm) is typical for 66" (167.6 cm) installation height.

*** Variable depth for 13" (33 cm) to 16" (40.6 cm) cabinet, see below table, the sizes in left column are flush, the size in right column are stands out.

	Flush Depth (cabinet + door)	Stand-out Depth (cabinet + door)
	<p>A. (Cabinet + Door) B. Bump out Mounting plate</p>	<p>A. (Cabinet + Door) B. Bump out Mounting plate</p>
L	13 3/4" to 14" (35 cm to 35.6 cm)	13 to 13 3/4" (33 cm to 35 cm)
M	14 1/4" to 14 1/2" (36.2 cm to 36.8 cm)	14" to 14 1/4" (35.6 cm to 36.2 cm)
N	14 3/4" to 15" (37.5 cm to 38.1 cm)	14 1/2" to 14 3/4" (36.8 cm to 37.5 cm)
P	15 1/4" to 15 1/2" (38.7 cm to 39.4 cm)	15" to 15 1/4" (38.1 cm to 38.7 cm)
R	15 3/4" to 16" (40 cm to 40.6 cm)	15 1/2" to 15 3/4" (39.4 cm to 40 cm)

Product Dimensions

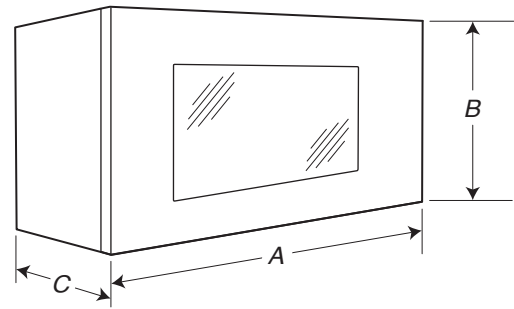

- A. 29 7/8" (76.1 cm)
- B. 17 7/8" (45.4 cm)
- C. 12 1/8" (31.3 cm)

Find the Wall Stud(s)

NOTE: If no wall studs exist within the cabinet opening, do not install the microwave oven.

See illustrations in "Possible Wall Stud Configurations."

1. Using a stud finder, locate the edges of the wall stud(s) within the opening.
2. Mark the center of each stud, and draw a plumb line down each stud center. See illustrations in "Possible Wall Stud Configurations."

Possible Wall Stud Configurations

These depictions show examples of preferred installation configurations with the mounting plate.

No Wall Studs at End Holes
Figure 1

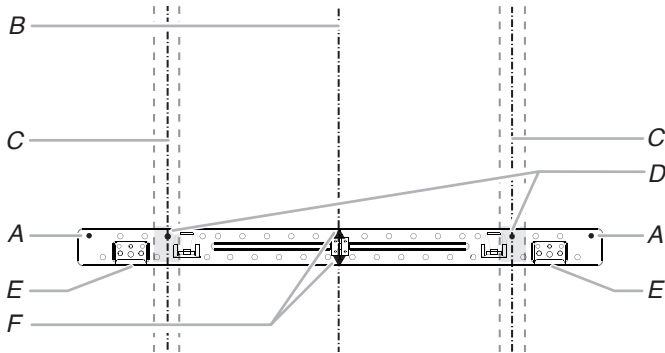

- | | |
|--|----------------------------------|
| A. End holes (on mounting plate) | D. Holes for lag screws |
| B. Cabinet opening vertical centerline | E. Support tabs |
| C. Wall stud centerlines | F. Mounting plate center markers |

No Wall Studs at End Holes
Figure 2

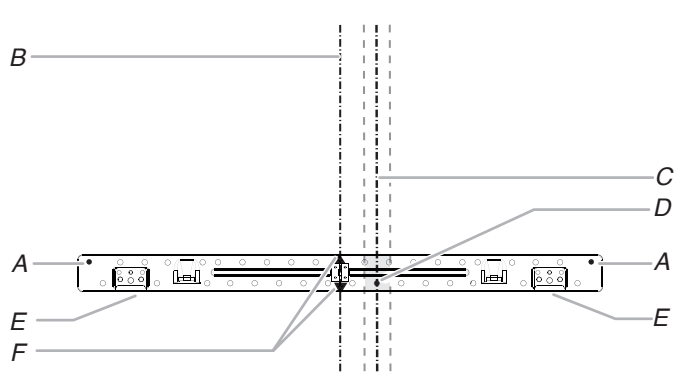

NOTE: If wall stud is within 6" (15.2 cm) of the vertical centerline, only recirculation or roof venting installation can be done.

- | | |
|--|----------------------------------|
| A. End holes (on mounting plate) | D. Holes for lag screws |
| B. Cabinet opening vertical centerline | E. Support tabs |
| C. Wall stud centerlines | F. Mounting plate center markers |

Wall Stud at End Holes
Figure 3

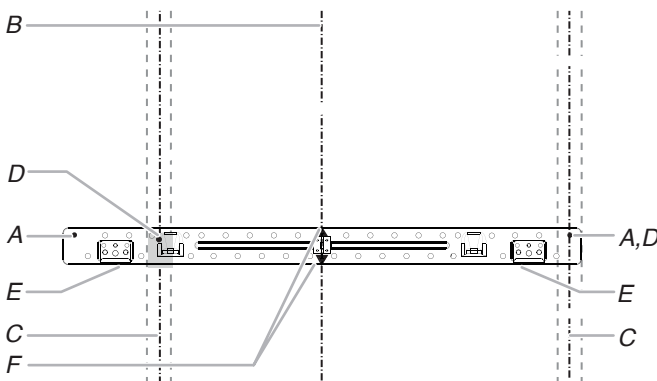

- | | |
|--|----------------------------------|
| A. End holes (on mounting plate) | D. Holes for lag screws |
| B. Cabinet opening vertical centerline | E. Support tabs |
| C. Wall stud centerlines | F. Mounting plate center markers |

Wall Stud at End Holes
Figure 4

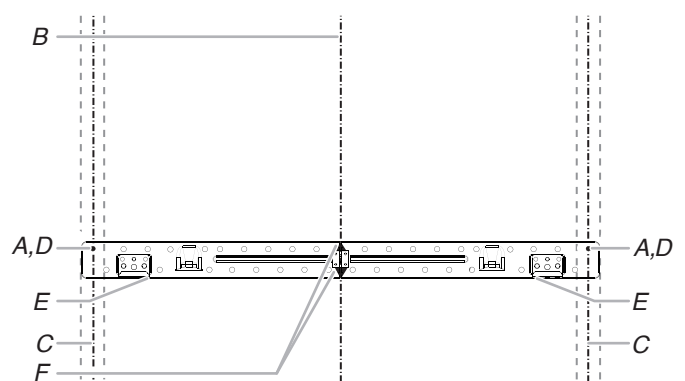

- | | |
|--|----------------------------------|
| A. End holes (on mounting plate) | D. Holes for lag screws |
| B. Cabinet opening vertical centerline | E. Support tabs |
| C. Wall stud centerlines | F. Mounting plate center markers |

Mark Upper Cabinet

- Using measuring tape, and clearly mark the vertical centerline of the opening. Make sure it is align with the vertical wall centerline.

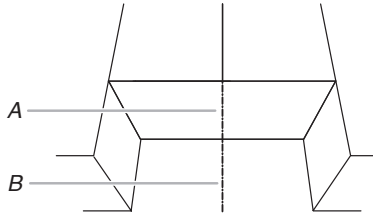

A. Upper Cabinet Centerline
B. Wall Centerline

The upper cabinet template is fit for depth of 13" (35 cm) to 16" (40.6 cm) cabinet installation, but need some adjustment for different depth. See the following steps.

- Using measuring tape, measure the depth of the cabinet. The upper cabinet template is for variable cabinet depth use, find a dimension of your cabinet in below table.

	Flush Depth (cabinet + door)	Stand-out Depth (cabinet + door)
L	13 ³ / ₄ " to 14" (35 cm to 35.6 cm)	13" to 13 ³ / ₄ " (33 cm to 35 cm)
M	14 ¹ / ₄ " to 14 ¹ / ₂ " (36.2 cm to 36.8 cm)	14" to 14 ¹ / ₄ " (35.6 cm to 36.2 cm)
N	14 ³ / ₄ " to 15" (37.5 cm to 38.1 cm)	14 ¹ / ₂ " to 14 ³ / ₄ " (36.8 cm to 37.5 cm)
P	15 ¹ / ₄ " to 15 ¹ / ₂ " (38.7 cm to 39.4 cm)	15" to 15 ¹ / ₄ " (38.1 cm to 38.7 cm)
R	15 ³ / ₄ " to 16" (40 cm to 40.6 cm)	15 ¹ / ₂ " to 15 ³ / ₄ " (39.4 cm to 40 cm)

NOTE: There are two install methods, one is flush to the cabinet door, another one is stand-out from the cabinet door. Find the dimension of your cabinet in above table, the dimensions in the left column are flush to the cabinet door, the dimensions in the right column are stand-out from the cabinet door.

Flush to the cabinet door, front alignment installation, follow below steps:

- For example, the cabinet depth is 14" (35.6 cm), you need to cut or fold the grey portion of the upper cabinet template.

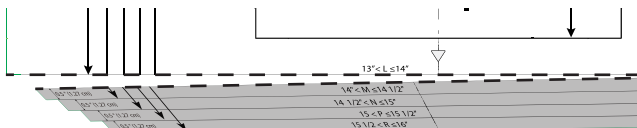

- Place and tape the upper cabinet template against the bottom of the upper cabinet.

NOTES:

- Make sure the front edge of the upper cabinet template align with the front edge of upper cabinet.
- Make sure the center marks on the upper cabinet template align with the upper cabinet centerline which draw in step 1.

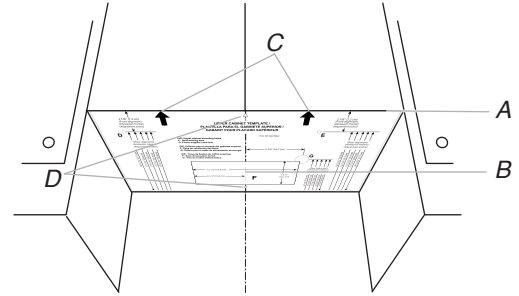

A. Front Edge of the Upper Cabinet Template and Front Edge of Upper Cabinet
B. Upper Cabinet Centerline
C. Arrows on Upper Cabinet Template
D. Center Marks on Upper Cabinet Template

NOTE: If the upper cabinet doors protrude from the upper cabinet, the template can be adjusted outward to be flush with the upper cabinet door.

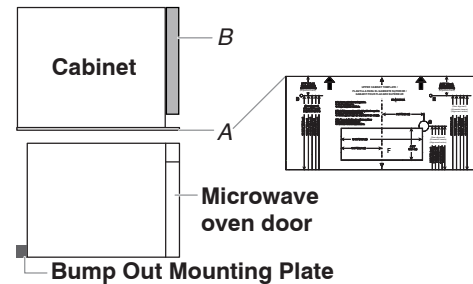

A. Front Edge of Template
B. Upper Cabinet Door

Stand-out from the cabinet door, back alignment installation, follow below steps:

- For example, the cabinet depth is 13¹/₂" (34.2 cm), you need to cut or fold the grey portion of the upper cabinet template.

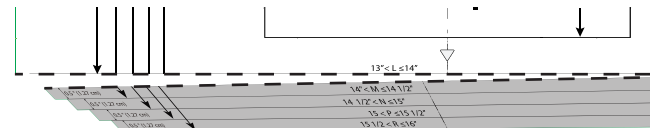

6. Place and tape the upper cabinet template against the bottom of the upper cabinet.

NOTES:

- Make sure the L line on the upper cabinet template align with the back edge of upper cabinet.
- Make sure the center marks on the upper cabinet template align with the upper cabinet centerline which draw in step 1.

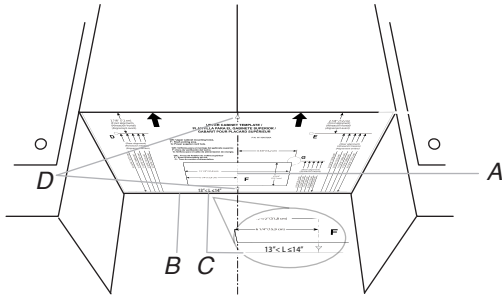

A. Upper Cabinet Centerline and Upper Cabinet Template Centerline
 B. Back edge of the Upper Cabinet
 C. L Line on Upper Cabinet Template
 D. Center Marks on Upper Cabinet Template

NOTE: If the front edge of the upper cabinet is lower than the back edge, lower the wall template so that its top is level with the front edge of the cabinet.

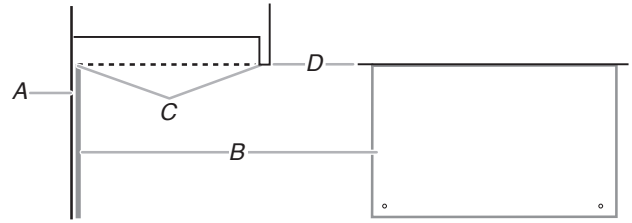

A. Rear wall
 B. Back edge of the Upper Cabinet
 C. Top of wall template must align with front edge of cabinet
 D. Front edge of upper cabinet

Drill Holes in Upper Cabinet

1. Using a 3/4" (1.9 cm) hole saw, cut out the power cord hole (A), which is "G" on the upper cabinet template.
2. Drill two mounting nut holes (B), which are 3/8" (10 mm) holes at points "D" and "E" on the upper cabinet template. These are for two 1/4-20 x 3" bolts and washers used to secure the microwave oven to the upper cabinet.

Mark Rear Wall

The microwave oven must be installed on a minimum of 1 wall stud, preferably 2, using a minimum of 1 lag screw, preferably 2. See "Find the Wall Stud(s)" section for find the wall studs.

1. Using measuring tape, find and clearly mark the vertical centerline of the opening.

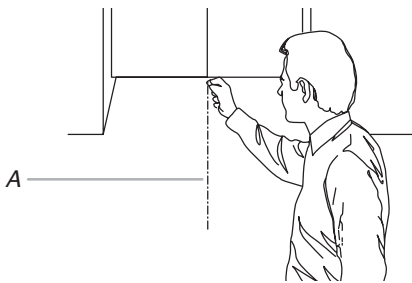

A. Centerline

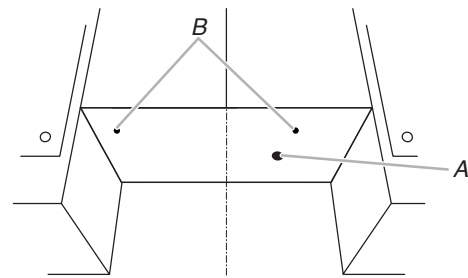

A. Power Cord Hole
 B. Mounting Nut Holes

2. Tape the Wall template in place. Align the center mark on the wall template over the vertical centerline draw in step 1. Make sure the wall template is level, and that the top of the wall template is butted up against the bottom edge of the upper cabinet.

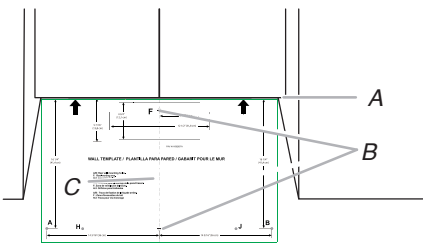

A. Bottom Edge of Upper Cabinet and Top of the Wall Template
 B. Center Marks on Wall Template
 C. Centerline

NOTE: If upper cabinet is metal, the supply cord bushing needs to be installed around the supply cord hole as shown.

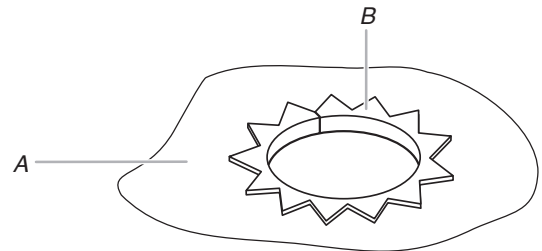

A. Metal cabinet
 B. Power supply cord bushing

Below steps are for roof venting installation only, skip this steps if for recirculation venting or wall venting installation

3. Cut 3/4 (1.9 cm) hole at one corner of the shaded rectangular area "F" on the upper cabinet template.
4. Using a keyhole saw, cut out the rectangular area.

NOTE: If the front edge of the upper cabinet is lower than the back edge, lower the wall template so that its top is level with the front edge of the cabinet.

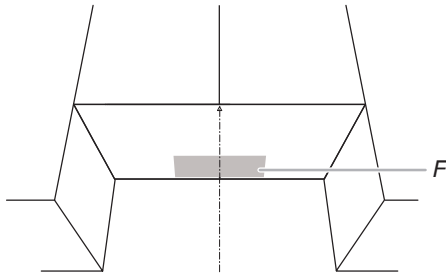

F. Roof Venting Cutout Area

Drill Holes in Rear Wall

In addition to being installed on at least one wall stud, the mounting plate must attach to the wall at both end holes. If the end holes are not over wall studs, use two 3/16-24 x 3" round head bolts with toggle nuts; if one end hole is over a wall stud, use one lag screw and one 3/16-24 x 3" round-head bolt with toggle nut; or if both end holes are over wall studs, use two lag screws. Following are four installation configurations.

Installation for No Wall Studs at End Holes (See figure 1 in the "Locate Wall Studs" section)

1. Drill two 5/8" (1.6 cm) holes through the wall at both end holes (A and B).
2. Drill four 3/16" (5 mm) lag screw hole(s), two into the wall studs at the holes (D and E), and two into the wall at the holes (H and J).

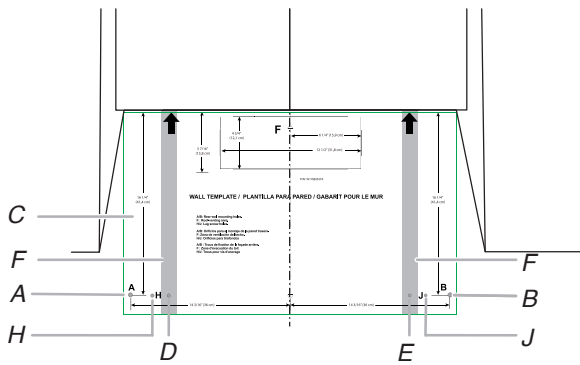

A and B. Two End Holes
C. Wall Template
D, E, H, and J. Four Lag Screw Holes
F. Wall Stud

Installation for No Wall Studs at End Holes (See figure 2 in the "Locate Wall Studs" section)

1. Drill two 5/8" (1.6 cm) holes through the wall at both end holes (A and B).
2. Drill four 3/16" (5 mm) lag screw hole(s), two into the wall studs at the holes (D and E), and two into the wall at the holes (H and J).

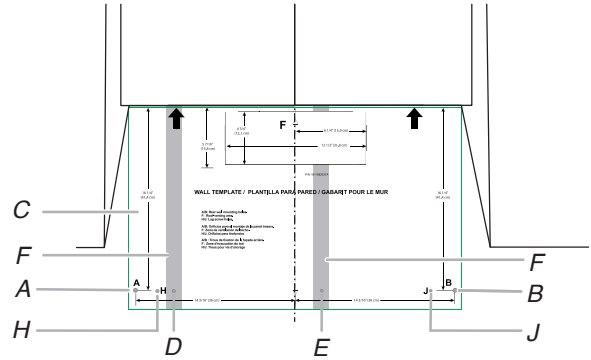

A and B. Two End Holes
C. Wall Template
D, E, H, and J. Four Lag Screw Holes
F. Wall Stud

Installation for No Wall Studs at End Holes (See figure 3 in the "Locate Wall Studs" section)

1. Drill one 5/8" (1.6 cm) hole through the wall at end holes (A).
2. Drill five 3/16" (5 mm) lag screw hole(s), one into the wall studs at the hole (D), and four into the wall at the holes (B, E, H, and, J).

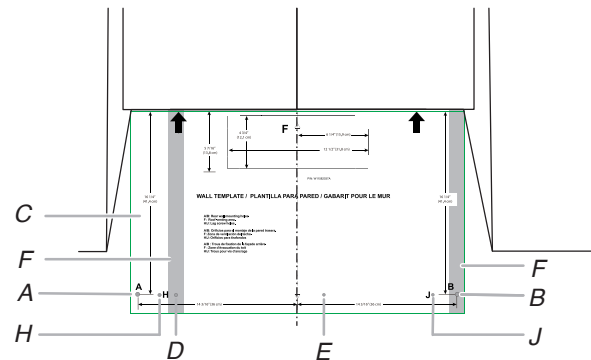

A. End Holes
B, E, H, and J. Five Lag Screw Holes
C. Wall Template
F. Wall Stud

Installation for Wall Studs at Both End Holes (See figure 4 in the "Locate Wall Studs" section)

1. Drill four 3/16" (5 mm) lag screw hole(s) into the wall studs and wall at the hole (A, B, H, and J).
2. Drill 5/8" (1.6 cm) holes through the wall at the hole (D and E).

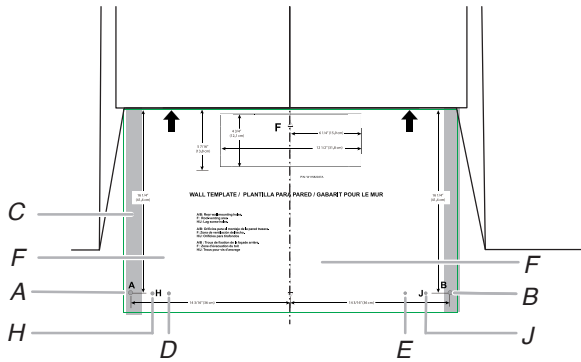

A and B. Two End Holes
 C. Wall Stud
 D, E, H, and J. Four Lag Screw Holes
 F. Wall Template

3. Select the right hooks for installation, there are two hooks on the M and N bracket, depends on the cabinet depth, select the right hook before installation.

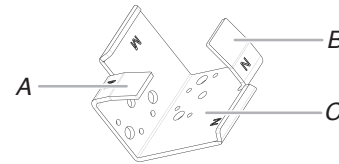

A. M Hook
 B. N Hook
 C. M and N Bracket

Cabinet Depth	
M	14" to 14 1/2" (35.6 cm to 36.8 cm)
N	14 1/2" to 15" (36.8 cm to 38.1 cm)

4. For example, the cabinet depth is 14 3/4", choose the N hook, and put the N hooks facing out.

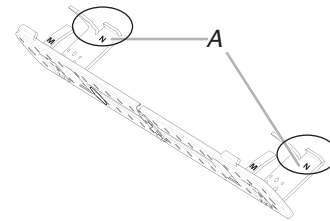

A. N Hook

5. Fasten M and N bracket with the screws which uninstalled in step 2.

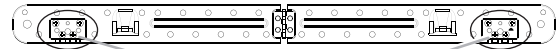

A. Screws

Prepare the Bump Out Mounting Plate

The default bump out mounting plate with L bracket is used for the upper cabinet larger than 13" and up to 14" depth. If your cabinet is 14" to 15", uninstall the L bracket, replace it with the M and N bracket. If your cabinet is 15" to 16", replace it with the P and R bracket. Use the right bracket before attach the bump out mounting plate onto the wall.

If your upper cabinet is larger than 13" and up to 14" depth.

1. Take out the bump out mounting plate, which is folded, open it to 180 degree at plate.

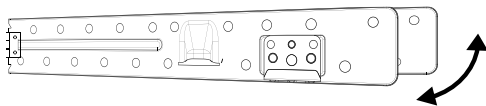

2. Attach the bump out mounting plate to wall, follow the steps in "Attach Bump Out Mounting Plate to Wall" section.

If your upper cabinet is larger than 14" and up to 15" depth.

1. Take out the bump out mounting plate, which is folded, open it to 180 degree at plate.

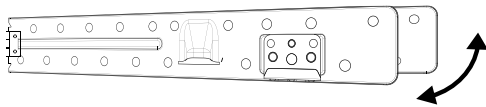

2. Uninstall the L bracket from the plate. Keep the L bracket for future use.

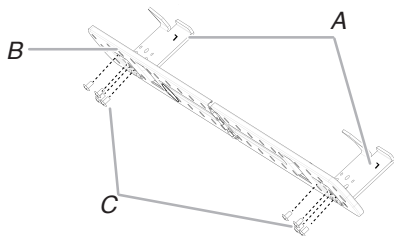

A. L Brackets
 B. Plate
 C. Screws

If your upper cabinet is larger than 14" and up to 15" depth.

1. Take out the bump out mounting plate, which is folded, open it to 180 degree at plate.

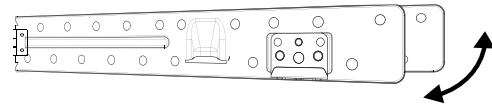

2. Uninstall the L bracket from the plate. Keep the L bracket for future use.

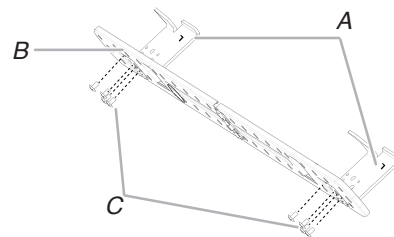

A. L Brackets
 B. Plate
 C. Screws

3. Select the right hooks for installation, there are two hooks on the R and P bracket, depends on the cabinet depth, select the right hook before installation.

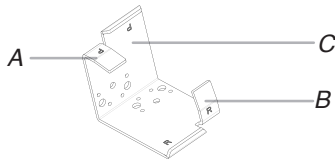

A. P Hook
B. R Hook
C. P and R Bracket

	Cabinet Depth
P	15" to 15 ¹ / ₂ " (38.1 cm to 39.4 cm)
R	15 ¹ / ₂ " to 16" (39.4 cm to 40.6 cm)

4. For example, the cabinet depth is 15¹/₄", choose the P hook, and put the P hooks facing out.

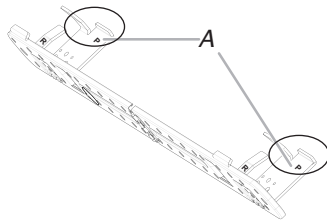

A. P Hook

5. Fasten P and R bracket with the screws which uninstalled in step 2.

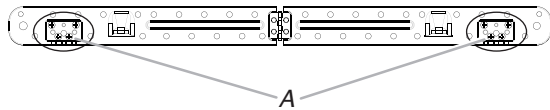

A. Screws

Attach Bump Out Mounting Plate to Wall

NOTE: Secure the mounting plate to the wall at both end holes drilled into the wall studs and/or drywall using either 3/16-24 x 3" round-head bolts and toggle nuts and 1/4 x 2" lag screws. Refer to illustrations in "Possible Wall Stud Configurations" in the "Locate Wall Stud(s)" section.

Note: If the depth of cabinet is slightly larger than 16", it may be necessary to use a number of the provided spacers, between the mounting plate and the wall, to achieve a more 'Flush' appearance. Stick spacer(s) before position mounting plate on the wall.

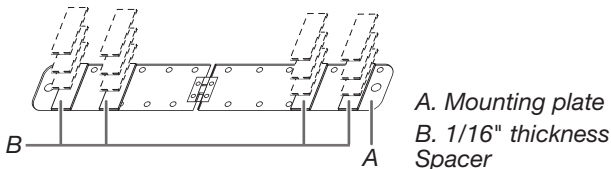

A. Mounting plate
B. 1/16" thickness Spacer

Depth of cabinet	Mounting plate
13" to 16"	Bump out mounting plate
16 ¹ / ₁₆ "	Mounting plate + 4 piece spacer
16 ¹ / ₈ "	Mounting plate + 8 pieces spacer
16 ³ / ₁₆ "	Mounting plate + 12 piece spacer
16 ¹ / ₄ "	Mounting plate + 16 pieces spacer

No Wall Studs at End Holes (Figure 1)

NOTE: The mounting plate must be secured to the wall on at least 1 wall stud as well as at both ends.

1. With the support hooks of the mounting plate facing forward, insert 3/16-24 x 3" round-head bolts through both end holes (A and B), insert 1/4 x 2" lag screws (D, E, H, and J).

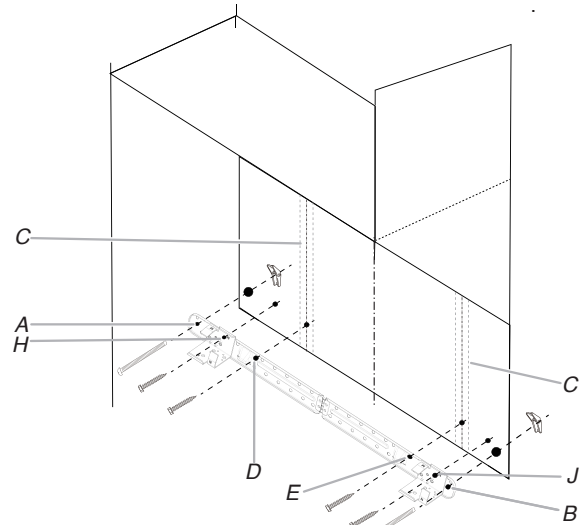

A and B. Two End Holes
C. Wall Studs
D, E, H, and J. Four Lag Screw Holes

NOTE: Start toggle nuts on bolts from the back of the mounting plate. Leave enough space for the toggle nuts to go through the wall and to open.

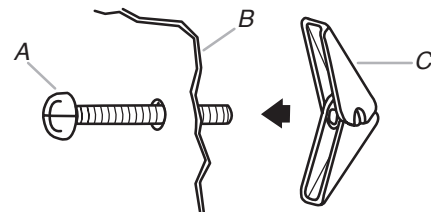

A. 3/16-24 x 3" round-head bolt
B. Mounting plate
C. Spring toggle nut

2. Position mounting plate on the wall.
3. Push the 2 bolts with toggle nuts through the drywall, and finger tighten the bolts to make sure toggle nuts have opened against drywall.

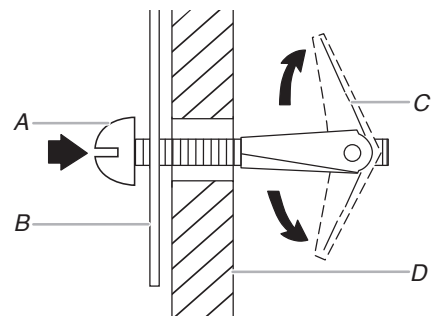

A. 3/16-24 x 3" round-head bolt
B. Mounting plate
C. Spring toggle nut
D. Drywall

4. Insert lag screw(s) into the hole(s) drilled into wall stud(s) in Step 2 of "Installation for No Wall Studs at End Holes" in the "Drill Holes in Rear Wall" section.
5. Check alignment of mounting plate, making sure it is level.
6. Securely tighten all lag screws and bolts.

No Wall Studs at End Holes (Figure 2)

Follow the install steps in Figure 1.

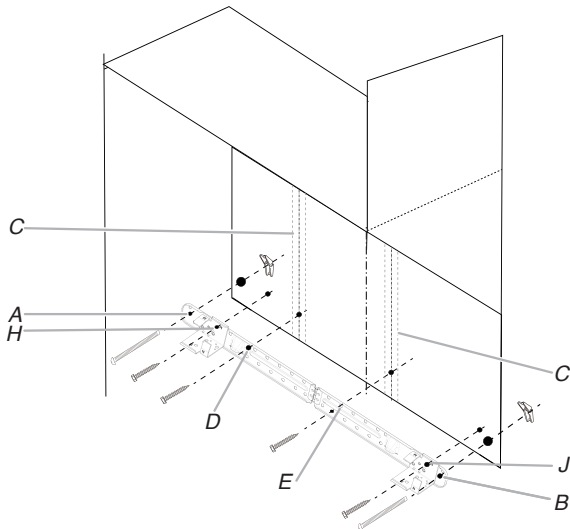

A and B. Two End Holes
 C. Wall Studs
 D, E, H, and J. Four Lag Screw Holes

Wall Stud at End Hole (Figure 3)

Follow the install steps in Figure 1.

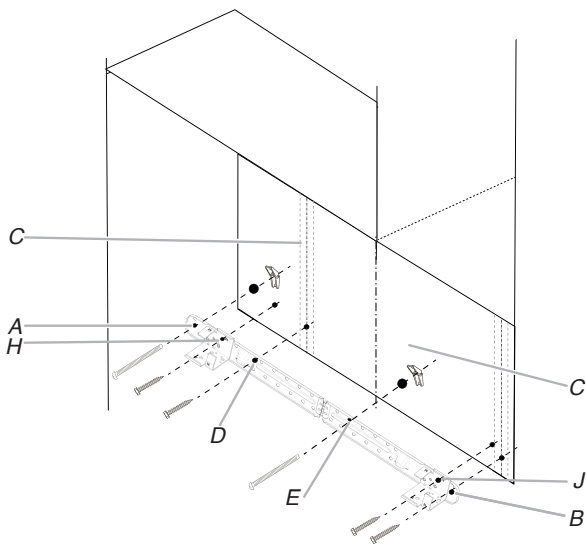

A and B. Two End Holes
 C. Wall Studs
 D, E, H, and J. Four Lag Screw Holes

Wall Stud at End Hole (Figure 4)

Follow the install steps in Figure 1.

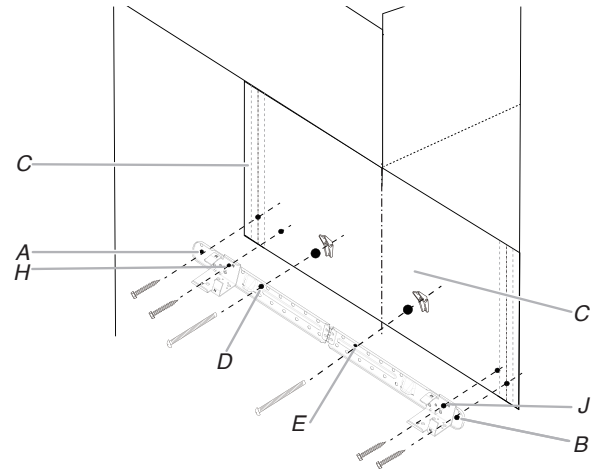

A and B. Two End Holes
 C. Wall Studs
 D, E, H, and J. Four Lag Screw Holes

Checking the hooks have been inserted into the right position

During attaching the microwave oven to the bump out kit, check if the bump out kit hanging hooks have been inserted into the microwave oven bottom plate back holes, and the hanging stoppers against the microwave oven back, reference below illustration. If not in position, adjust the microwave.

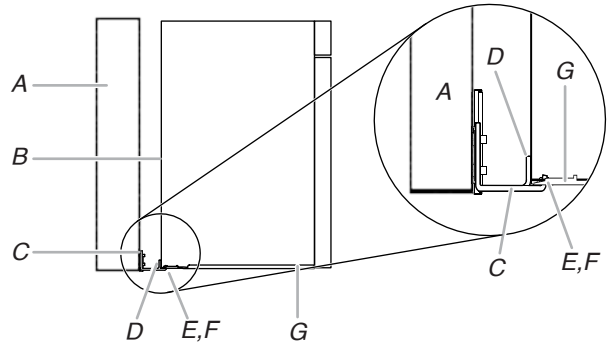

A. Wall
 B. Microwave oven back
 C. Bump Out Kit
 D. Hanging Stopper
 E. Hanging Hook
 F. Bottom Plate Back Hole
 G. Bottom Plate