



SMALL ELECTRIC BUILT-IN CONVECTION OVEN

PETIT FOUR À CONVECTION ENCASTRÉ

Use & Care Guide

For questions about features, operation/performance, parts, accessories, warranty, or service in the U.S.A., call:
1-866-698-2538 or visit our website at **www.whirlpool.com**.
In Canada, call: **1-800-807-6777** or visit our website at **www.whirlpool.ca**.

Guide d'utilisation et d'entretien

Pour des questions à propos des caractéristiques, du fonctionnement/rendement, des pièces, accessoires, garantie, ou dépannage,
composer le : **1-866-698-2538** ou visitez notre site Web au **www.whirlpool.com**.
Au Canada, composer le **1-800-807-6777** ou visitez notre site Web au **www.whirlpool.ca**.

TABLE OF CONTENTS

OVEN SAFETY	2
OVEN USE	3
Product Description	3
Control Panel Description	3
Oven Vent(s)	4
Positioning Racks and Bakeware	4
Touch Panel.....	4
Display.....	4
Display Navigation	5
How To Use The Touch Display	5
First Time Use	5
Daily Use	6
COOKING MODES	8
Manual Cooking.....	8
Favorites.....	9
Frozen Bake™	9
Assisted Cooking	9
Doneness	9
Settings	10
Aluminum Foil.....	11
Broiling.....	11
Traditional Cooking	11
Bakeware.....	11
Preheating and Oven Temperature	12
Baking and Roasting.....	12
Accessories	12
OVEN CARE	13
Self Cleaning Cycle	13
General Cleaning.....	14
Oven Lights	14
TROUBLESHOOTING	15
ASSISTANCE OR SERVICE	16

TABLE DES MATIÈRES

SÉCURITÉ DU FOUR	17
UTILISATION DU FOUR	18
Description du produit	18
Description du tableau de commande	18
Positionnement des grilles et des ustensiles de cuisson au four..	19
Tableau tactile	19
Affichage	19
Événements du four	19
Affichage du menu	20
Comment utiliser l'écran tactile	20
Première utilisation.....	20
Utilisation quotidienne.....	21
MODES DE CUISSON	23
Cuisson manuelle.....	23
Favorites (Favoris)	24
Frozen Bake™ (Cuisson d'aliments surgelés).....	24
Assisted Cooking (Cuisson assistée).....	24
Degré de cuisson	24
Settings (réglages).....	25
Papier d'aluminium	26
Cuisson au gril.....	26
Cuisson traditionnelle.....	26
Ustensiles de cuisson	26
Préchauffage et température du four.....	27
Cuisson et rôtissage au four	27
Accessoires	27
ENTRETIEN DU FOUR	28
Programme d'autonettoyage	28
Nettoyage général.....	29
Lampes du four	29
DÉPANNAGE	30
ASSISTANCE OU DÉPANNAGE	31

OVEN SAFETY

Your safety and the safety of others are very important.

We have provided many important safety messages in this manual and on your appliance. Always read and obey all safety messages.



This is the safety alert symbol.

This symbol alerts you to potential hazards that can kill or hurt you and others.

All safety messages will follow the safety alert symbol and either the word "DANGER" or "WARNING."

These words mean:

⚠ DANGER

You can be killed or seriously injured if you don't immediately follow instructions.

⚠ WARNING

You can be killed or seriously injured if you don't follow instructions.

All safety messages will tell you what the potential hazard is, tell you how to reduce the chance of injury, and tell you what can happen if the instructions are not followed.

IMPORTANT SAFETY INSTRUCTIONS

WARNING: To reduce the risk of fire, electrical shock, injury to persons, or damage when using the oven, follow basic precautions, including the following:

- Proper Installation – Be sure the oven is properly installed and grounded by a qualified technician.
- Never Use the Oven for Warming or Heating the Room.
- Do Not Leave Children Alone – Children should not be left alone or unattended in area where oven is in use. They should never be allowed to sit or stand on any part of the oven.
- Wear Proper Apparel – Loose-fitting or hanging garments should never be worn while using the oven.
- User Servicing – Do not repair or replace any part of the oven unless specifically recommended in the manual. All other servicing should be referred to a qualified technician.
- Storage in Oven – Flammable materials should not be stored in an oven.
- Do Not Use Water on Grease Fires – Smother fire or flame or use dry chemical or foam-type extinguisher.
- Use Only Dry Potholders – Moist or damp potholders on hot surfaces may result in burns from steam. Do not let potholder touch hot heating elements. Do not use a towel or other bulky cloth.
- Use Care When Opening Door – Let hot air or steam escape before removing or replacing food.
- Do Not Heat Unopened Food Containers – Build-up of pressure may cause container to burst and result in injury.

- Keep Oven Vent Ducts Unobstructed.
- Placement of Oven Racks – Always place oven racks in desired location while oven is cool. If rack must be moved while oven is hot, do not let potholder contact hot heating element in oven.
- DO NOT TOUCH HEATING ELEMENTS OR INTERIOR SURFACES OF OVEN – Heating elements may be hot even though they are dark in color. Interior surfaces of an oven become hot enough to cause burns. During and after use, do not touch, or let clothing or other flammable materials contact heating elements or interior surfaces of oven until they have had sufficient time to cool. Other surfaces of the oven may become hot enough to cause burns – among these surfaces are oven vent openings and surfaces near these openings, oven doors, and windows of oven doors.

For self-cleaning ovens:

- **CAUTION:** DO NOT LEAVE FOOD OR COOKING UTENSILS, ETC., IN OVEN DURING THE PYROLYTIC SELF-CLEANING MODE OF OPERATION.
- Do Not Clean Gasket – The gasket is essential for a good seal. Care should be taken not to rub, damage, or move the gasket.
- Do Not Use Oven Cleaners – No commercial oven cleaner or oven liner protective coating of any kind should be used in or around any part of the oven.
- Clean Only Parts Listed in Manual.
- Before Self-Cleaning the Oven – Remove broiler pan and other utensils.

SAVE THESE INSTRUCTIONS

OVEN USE

Product Description

These instructions cover several different models. The range you have purchased may have some or all of the items listed. The locations and appearances of the features shown here may not match those of your model. Refer to this manual or the Frequently Asked Questions (FAQs) section of our website at www.whirlpool.com for more detailed instructions. In Canada, refer to the Customer Service Section at www.whirlpool.ca.

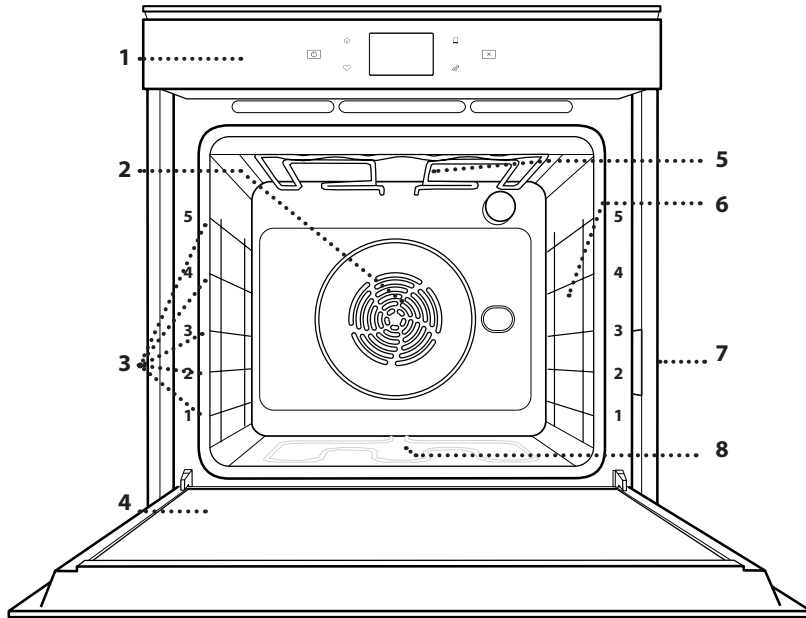

1. Control panel
2. Fan and Circular heating element (not visible)
3. Shelf guides (the level is indicated on the front of the oven)
4. Door
5. Upper heating element/grill
6. Lamp
7. Identification plate (do not remove)
8. Lower heating element (not visible)

Control Panel Description

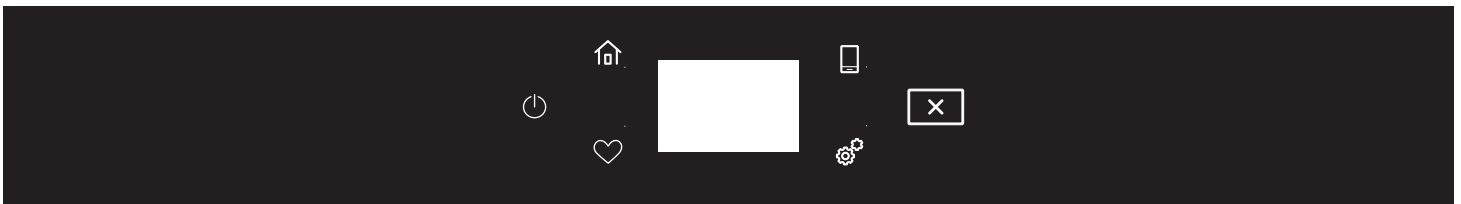

ICON	KEYPAD	FEATURE	INSTRUCTIONS
	Settings	Oven Use Functions	Enables you to personalize the audible tones and oven operation to suit your needs. See the “Settings” and “More Modes” sections.
	Home	Home Screen	If pressed once, it enables the user to return to the “Cooking Methods” and “Assisted Cooking” screen. If pressed twice, the time of day is displayed.
	Favorites	Favorites	Allows you to save the cycles that you use on a frequent basis.
	Remote Enable/Disable	Remote Enable/Disable	To enable or disable use of the Whirlpool® app.
	Oven Power	Oven Function Power	The Oven Power keypad begins oven function and wakes it from sleep mode.
	Cancel	Oven Function Cancel	The Cancel keypad stops any oven function except the Clock, Timer, and Control Lock.

Oven Vent(s)

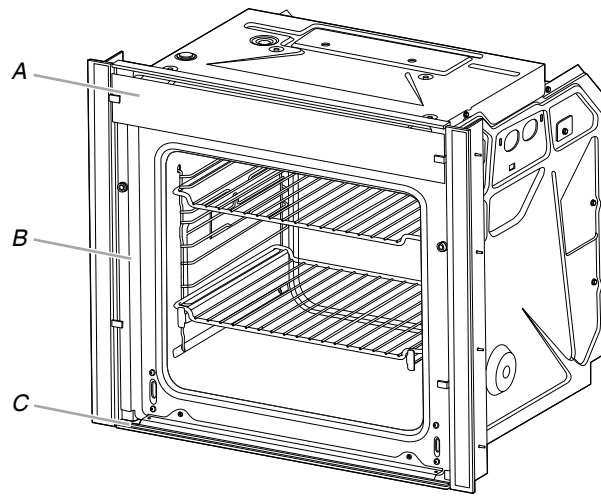

- A. Control panel
- B. Oven
- C. Oven vent

The oven vent(s) should not be blocked or covered since they allow the inlet of fresh air into the cooling system. Also, the bottom vent should not be blocked or covered since it allows the inlet of fresh air into the cooling system and the outlet of hot air from the cooling system. Blocking or covering vents will cause poor air circulation, affecting cooking, cleaning, and cooling results.

Positioning Racks and Bakeware

IMPORTANT: To avoid permanent damage to the porcelain finish, do not place food or bakeware directly on the oven door or bottom.

Racks

- Position racks before turning on the oven.
- Do not position racks with bakeware on them.
- Make sure racks are level.
- Place food so it will not rise into the broil element. Allow at least 1/2" (1.3 cm) between pans and the broil element.

To move a rack, pull it out to the stop position, raise the front edge, and then lift it out. Use the following illustration and charts as a guide for positioning racks.

Inserting the Wire Shelf and other Accessories

Insert the wire shelf horizontally by sliding it across the shelf guides in correspondence to the rack positions pictured below, making sure that the side with the raised edge is facing upwards.

Other accessories, such as the drip tray and the baking tray, are inserted horizontally in the same way as the wire shelf.

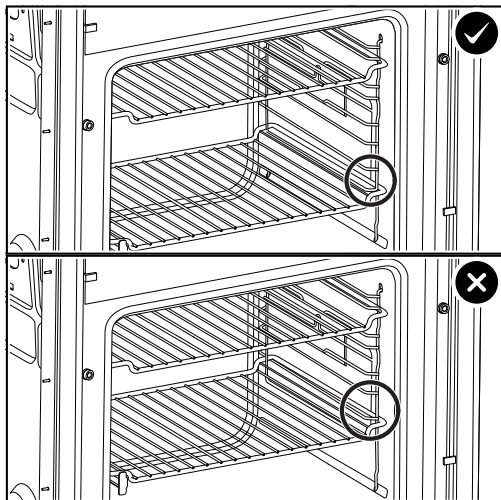

Rack Positions

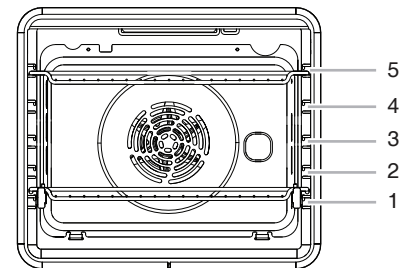

Touch Panel

The touch panel houses the control menu and function controls. The touch keypads are very sensitive and require only a light touch to activate. Scroll up, down, left, or right to explore the different options and features.

For more information about the individual controls, see their respective sections in this manual.

Display

The display is for both the menu and oven function controls. The touch panel allows you to scroll through the oven menus. The display is very sensitive and requires only a light touch to activate and control.

When an oven is in use, the display will show the clock, mode, oven temperature, kitchen timer, and oven timer, if set. If the oven timer is not set, you can set it from this screen.

After approximately 2 minutes of inactivity, the display will go into sleep mode and the display will dim. When the oven is in operation, the display will remain bright.

During use, the display will show menus and the appropriate selections for the options being chosen.

Display Navigation

If the oven is off, touch the Oven Power to activate the menu. From this screen, all automatic cooking programs can be activated, all manual cooking programs can be set, options can be adjusted, and instructions, preparation, and tips can be accessed.

How To Use The Touch Display



To scroll through a menu or a list:

Simply swipe your finger across the display to scroll through the items or values.



To select or confirm:

Tap the screen to select the value or menu item you require.

To go back to the previous screen:

Tap <.

To confirm a setting or go to the next screen:

Tap "SET" or "NEXT".

First Time Use

You will need to configure the product when you switch on the appliance for the first time.

The settings can be changed subsequently by pressing  to access the "Tools" menu.

1. SELECT THE LANGUAGE

You will need to set the language and the time when you switch on the appliance for the first time.

- Swipe across the screen to scroll through the list of available languages.



- Tap the language you require.

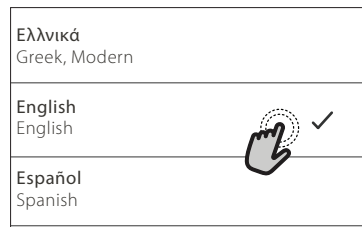

Tapping < will take you back to the previous screen.

2. SETTING UP WI-FI

To enable the appliance to be controlled remotely, you will need to complete the connection process successfully first.

This process is necessary to Register your appliance and connect it to your home network.

- Tap "SETUP NOW" to proceed with setup connection.

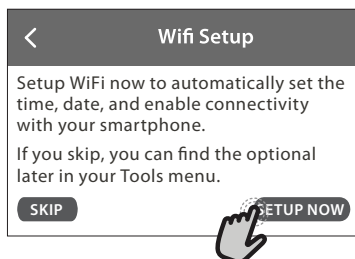

Or tap "SKIP" to connect your product later.

To set up the Wi-Fi connection, refer to the Connected Guide provided with the appliance.

3. SETTING THE TIME AND DATE

Connecting the oven to your home network will set the time and date automatically. Otherwise you will need to set them manually.

- Tap the relevant numbers to set the time and the AM/PM button on the bottom-left.

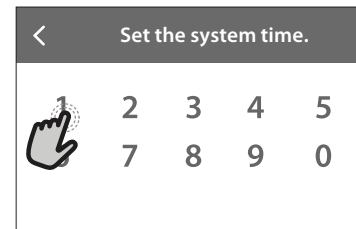

- Tap "SET" to confirm.

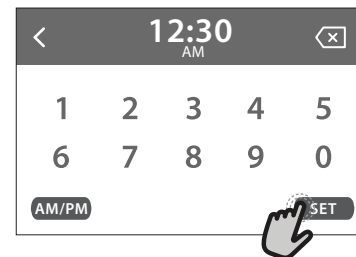

Once you have set the time, you will need to set the date.

- Tap the relevant numbers to set the date.
- Tap "SET" to confirm.

4. HEAT THE OVEN

A new oven may release odors that have been left behind during manufacturing: this is completely normal.

Before starting to cook food, we therefore recommend heating the oven with it empty in order to remove any possible odors.

Remove any protective cardboard or transparent film from the oven and remove any accessories from inside it.

Heat the oven to 390°F for around one hour.

It is advisable to air the room after using the appliance for the first time.

Daily Use

1. SELECT A FUNCTION

- To switch on the oven, press  or touch anywhere on the screen.

The display allows you to choose between Manual and Assisted Cooking.

- Tap the main function you require to access the corresponding menu.

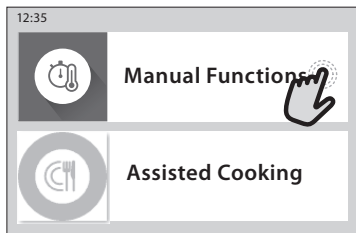

- Scroll up or down to explore the list.
- Select the function you require by tapping it.

2. SET MANUAL FUNCTIONS

After having selected the function you require, you can change its settings. The display will show the settings that can be changed.

TEMPERATURE / BROIL LEVEL

- Scroll through the suggested values and select the one you require.



If allowed by the function, you can tap  to enable/disable preheating.



- To start setting the duration, tap “Set Cook Time”.

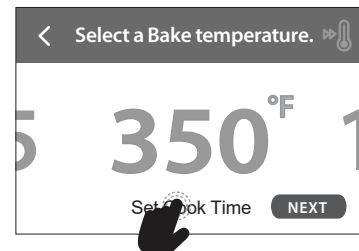

- Tap the relevant numbers to set the cooking time you require.



- To confirm tap “NEXT”.
- To change the entered cooking duration time, tap on the displayed cooking timer, edit with the new time and tap “RESUME”.
- To cancel a set cooking duration time, tap the duration and then select “STOP”.

3. SET START / END TIME DELAY

You can delay cooking before starting a function: The function will start or end at the time you select in advance.

- Tap “DELAY” to set the start time or end time you require.

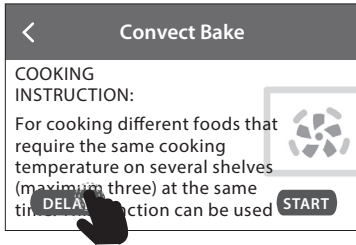

- Once you have set the required delay, tap “START DELAY” to start the waiting time.
- Place the food in the oven and close the door: The function will start automatically after the period of time that has been calculated.

Programming a delayed cooking start time will disable the oven preheating phase: The oven will reach the required temperature gradually, meaning that cooking times will be slightly longer than those listed in the cooking table.

- To activate the function immediately and cancel the programmed delay time, tap .

4. START THE FUNCTION

- Once you have configured the settings, tap “START” to activate the function.

You can change the values that have been set at any time during cooking by tapping the value you want to amend.

If the oven is hot and the function requires a specific maximum temperature, a message will be shown on the display.

- Press  to stop the active function at any time.

5. PREHEATING

Once the function has been started the display indicates the status of preheating phase.

If you did not enter the cooking time in the previous steps, you can always press on the “SET COOK TIME” icon and enter the desired time. Tap on “NEXT” to confirm.

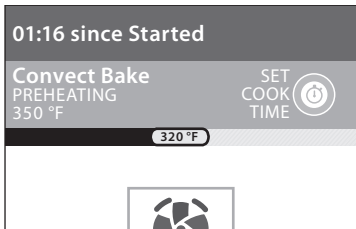

Once this phase has been finished, an audible signal will sound and the display will indicate that the oven has reached the set temperature.

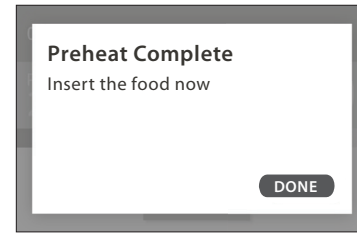

- Open the door.
- Place the food in the oven.
- Close the door and tap “DONE” to start cooking.

Placing the food in the oven before preheating has finished may have an adverse effect on the final cooking result.

Opening the door during the preheating phase will pause it.



The cooking time does not include a preheating phase.

6. END OF COOKING

An audible signal will sound and the display will indicate that cooking is complete.

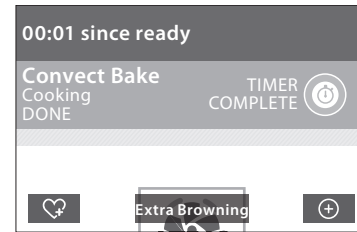
With some functions, once cooking has finished you can give your dish extra browning, extend the cooking time or save the function as a favorite.



- Tap  to save it as a favorite.
- Select “Extra Browning” to start a five-minute browning cycle.
- Tap  to save prolong the cooking.

COOKING MODES

Manual Cooking

WARNING

Food Poisoning Hazard

Do not let food sit in oven more than one hour before or after cooking.

Doing so can result in food poisoning or sickness.

3. Select the desired cooking function from the list. See the following table for descriptions.
4. Follow the on-screen prompts to set the temperature, optional cook time, and optional delay start, if available. Some cooking functions allow you to turn on/off the Preheat function. Some cooking functions have preset options for specific food types. Select the food type that most closely matches your recipe.
5. Press START to begin. If preheating is on, a tone will sound when preheating is complete.
6. Press the Oven Cancel keypad when finished cooking.

To set a Manual Cooking Function, follow these steps.

1. Press the Oven Power keypad.
2. Select the Cooking Modes option.

COOKING FUNCTION	SUGGESTED USAGE
Rapid Preheat	A Bake function that will preheat the oven quickly.
Bake	Used for cooking any kind of food on one rack.
Broil	Used for broiling thin foods on one rack.
Convect Broil	Used for roasting large cuts of meat.
Convect Bake	Used for cooking different foods on multiple racks at the same temperature.
Specialty Functions: Defrost	Used to speed up the defrosting of food. Place food in the middle shelf. Leave food in packaging to keep it from drying out.
Specialty Functions: Keep Warm	Used to keep already-cooked food warm until it is served.
Specialty Functions: Proof	Used to proof breads.
Specialty Functions: Convect Roast	Used for cooking large cuts of meat. Turn the meat during cooking for even browning, and baste the meat periodically to keep it moist.
Frozen Bake™	Used to cook premade frozen food, such as lasagna, pizza, pastries, french fries. No preheat is necessary. The oven automatically adjusts cooking temperature. For cooking time, follow the instructions on the packaging.
Self Clean (available on single ovens and the double oven upper cavity)	Used to clean the oven at extremely high temperatures. See the “Self Cleaning” section for more information.

Favorites

The Favorites feature stores the oven mode and temperature for your favorite recipe. As you continue to utilize your Favorites tool, your product will refine and tailor suggestions towards your cooking cravings/needs.

NOTE: A select set of Favorites and suggestions may be automatically shown on the Home screen based on your meal times.

To save a recipe, select the Favorites keypad and follow the prompts on the screen to customize your favorites.

Add an image or name to the favorite to customize it to your preferences.

Frozen Bake™ Option

The Frozen Bake™ function automatically selects the ideal cooking temperature and mode for 5 different types of ready frozen foods. The oven does not have to be preheated.

Consult food package for manufacturer's instructions on cooking time.

Because of the variation of the frozen food category, it might be necessary to prolong the cooking time in order to obtain the best result. Use the "+" button to prolong the cooking time by 2 minutes, 1 minute or 30 seconds.

Frozen bake instructions:

Food	Instructions	Wire Shelf Level
Lasagna	Use wire shelf with pan or tray	2
Pizza	Place food directly on rack or use wire shelf with pan or tray	3
Pastry	Use wire shelf with pan or tray	3
French Fries	Use wire shelf with pan or tray	3

NOTE: In case of sub-optimal cooking results, try a different wire shelf level.

Assisted Cooking

Assisted cooking helps you select the right mode for your everyday cooking needs.

Some modes allow you to skip preheat. Follow the prompts on screen for guidance throughout the cooking process.

Assisted cooking recipes include:

- Casseroles & Baked Pasta
 - Meat
 - Fish & Seafood
 - Vegetables
-

Doneness

NOTE: Can only be used on selected functions.

1. Switch on the oven by selecting the ON/HOME button or touching the display.
2. Select the Assisted Cooking.
3. Select the Food list.
4. Choose the food to cook from the list.
5. Food thickness (inches) or food weight (ounces) might be required for some foods, as a parameter for the assisted function.
6. External surface browning might be required for some foods. Select between LIGHT, NORMAL, etc. The external browning selection will prolong/reduce the final broiling stage of cooking.
7. Press START to begin the preheat cycle.

Browning setting recipes include:

- Potatoes
- Hamburger
- Other vegetables

Settings

The Settings keypad allows you access to functions and customization options for your oven. These settings allow you to set the clock, turn the audible signals and prompts on and off, change the language, and more.

Select the Settings keypad to view the Settings features:

- Kitchen Timer
- Light
- Self Clean (available on single ovens and the double oven upper cavity)
- Mute
- Control Lock

See the “More Modes” section for more information.

TOOL	NOTES
Kitchen Timer	Set a kitchen timer by manually entering the desired time into the keypad. <ol style="list-style-type: none">1. Select KITCHEN TIMER.2. Manually input the time to the desired timer length.3. Select START.4. Select the Cancel keypad to end the Kitchen Timer.
Light	Select the Light keypad to turn the light on and off. When the oven door is opened, the oven light will automatically turn on.
Self Clean (available on single ovens and the double oven upper cavity)	See the “Self Cleaning” section.
Mute	Select MUTE to mute or unmute the oven sounds.
Control Lock	<p>The Control Lock locks the control panel keypads to avoid unintended use of the oven(s). The Control Lock will remain set after a power failure, if set before the power failure occurs. When the control is locked, only the Oven Power and Settings keypads will function.</p> <p>The Control Lock is preset unlocked, but can be locked.</p> <p>To Lock or Unlock Control:</p> <ol style="list-style-type: none">1. Check that the oven is off.2. Select CONTROL LOCK.3. “Control Lock” will display.4. Scroll up to unlock. No keypads will function.

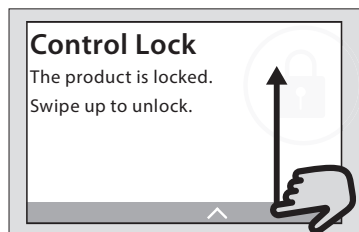

Preferences

Times and Dates

Set time and date preferences.

- **Your Meal Times:** Adjust when breakfast/lunch/dinner is shown
- Time
- Date
- Time Format (AM/PM vs 24 hour [Military Time])

Sound Volume

Set sound volume preferences.

- Timers and Alerts
- Buttons and Effects

Display Settings

Set the screen brightness.

- Display Brightness

Regional

Set regional preferences.

- **Language:** English or French

Info

- **Service and Support:** Displays model number, Customer Support contact info, and Diagnostics.
- **Restore Factory:** This will restore your product to the original factory default settings.

Aluminum Foil

IMPORTANT: To avoid permanent damage to the oven bottom finish, do not line the oven bottom with any type of foil or liner.

For best cooking results, do not cover entire oven rack with foil because air must be able to move freely.

To catch spills, place foil on rack below dish. Make sure foil is at least 1/2" (1.3 cm) larger than the dish and that it is turned up at the edges.

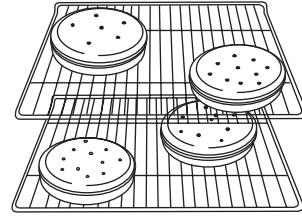

Broiling

When broiling, no preheating is necessary unless recommended otherwise in the recipe. Position food on rack above a drip tray, and then place it in the center of the oven rack. Close the oven door to ensure proper broiling temperature.

NOTE: Odors and smoke are normal the first few times the oven is used or if the oven is heavily soiled.

Changing the temperature when broiling allows more precise control when cooking. The lower the broil setting, the slower the cooking. Thicker cuts and unevenly shaped pieces of meat, fish and poultry may cook better at lower broil settings. Refer to the "Positioning Racks and Bakeware" section for more information.

On lower settings, the broil element will cycle on and off to maintain the proper temperature.

FOOD	RACK POSITION
Most broiling	5

For hamburger patties to have a well-seared exterior and a rare interior, use a flat rack in position 5. Cook over a drip tray filled with 2 cups (500 ml) of water. Broil for 15-30 minutes and turn two thirds of the way through cooking.

Traditional Cooking

FOOD	RACK POSITION
Large roasts, turkeys, angel food, bundt cakes, quick breads, pies	1 or 2
Yeast breads, casseroles, meat and poultry	2 or 3
Cookies, biscuits, muffins	3 or 4 when single rack baking; 1 and 3 when double-rack baking; 1, 3, and 5 when triple-rack baking; and 1, 3, 4, and 5 when quadruple-rack baking. For best results, use Bake function for single rack and Convection Bake function for multi-rack.
Cakes and Layer Cakes	3 or 4 when single rack baking; 2 and 4 when double-rack baking; 1, 3 and 5 when triple-rack baking; and 1, 3, 4 and 5 when quadruple-rack baking. For best results, use Bake function for single rack and Convection Bake function for multi-rack. Place the cakes as shown in the picture below.

NOTE: Additional racks may be required for multi-rack cooking.

Bakeware

To cook food evenly, hot air must be able to circulate. Allow 2" (5.0 cm) of space around bakeware and oven walls.

Use the following chart as a guide.

NUMBER OF PAN(S)	POSITION ON RACK
1	Center of rack.
2	Side by side or slightly staggered.
3	Refer to the previous illustration.

NOTE: Bakeware materials and color may affect results. Dark, dull, non-stick, or glass pans may require shorter baking times, in contrast insulated or stainless steel pans may require longer baking times. Follow bakeware manufacturer's recommendations.

Preheating and Oven Temperature

Preheating

When beginning a Bake cycle, the oven will begin preheating after Start is pressed. The oven will take approximately 6 minutes to reach 350°F (177°C) with all of the oven racks provided with your oven inside the oven cavity. Higher temperatures will take longer to preheat. The preheat cycle rapidly increases the oven temperature. The actual oven temperature will go above your set temperature to offset the heat lost when your oven door is opened to insert food. This ensures that when you place your food in the oven, the oven, will begin at the proper temperature. Insert your food when the preheat tone sounds. Do not open the door during preheat before the tone sounds.

Rapid Preheat

Rapid Preheat can be used to shorten the preheating time. Only one standard flat oven rack should be in the oven during Rapid Preheat. Extra racks should be removed prior to starting. The preheating cycle should be completed before placing food in the oven. When the Rapid Preheat cycle is complete, the oven starts a normal Bake cycle.

IMPORTANT: Rapid Preheat should be used only for one-rack baking.

Oven Temperature

While in use, the oven elements will cycle on and off as needed to maintain a consistent temperature, but they may run slightly hot or cool at any point in time due to this cycling. Opening the oven door while in use will release the hot air and cool the oven which could impact the cooking time and performance. It is recommended to use the oven light to monitor cooking progress.

Before baking and roasting, position racks according to the "Positioning Racks and Bakeware" section. When roasting, it is not necessary to wait for the oven preheat cycle to end before putting food in unless it is recommended in the recipe.

Baking and Roasting

The oven will take approximately 6 minutes to reach 350°F (177°C) with all oven racks inside the oven cavity. The preheat cycle rapidly increases the temperature inside the oven cavity.

Higher temperatures will take longer to preheat. Factors that impact preheat times include room temperature, oven temperature, and the number of racks. Unused oven racks can be removed prior to preheating your oven to help reduce preheat time. The actual oven temperature will go above the set temperature to offset the heat lost when the oven door is opened to insert food. This ensures that the oven will begin at the proper temperature when you place food in the oven. Insert food when the preheat tone sounds. Do not open the door during preheat until the tone sounds.

During baking or roasting, the bake and broil elements will cycle on and off in intervals to maintain the oven temperature.

Depending on the model, if the oven door is opened during baking or roasting, the heating elements (bake and broil) will turn off approximately 30 seconds after the door is opened. They will turn on again approximately 30 seconds after the door is closed.

Accessories

The number and the type of accessories may vary depending on which model is purchased.

Other accessories can be purchased separately, see "Assistance or Service" section.

Wire Shelf

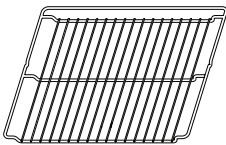

Use to cook food or as a support for pans, cake tins and other ovenproof items of cookware.

Drip Tray



Use as an oven tray for cooking meat, fish, vegetables, focaccia, etc. or position underneath the wire shelf to collect cooking juices.

Baking Tray

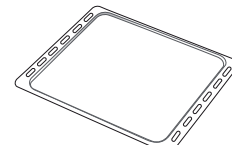

Use for cooking all bread and pastry products, but also for roasts and fish.

OVEN CARE

Self Cleaning Cycle

⚠ WARNING



Burn Hazard

Do not touch the oven during the Self-Cleaning cycle.

Keep children away from oven during Self-Cleaning cycle.

Failure to follow these instructions can result in burns.

IMPORTANT: The health of some birds is extremely sensitive to the fumes given off during the Self Cleaning cycle. Exposure to the fumes may result in death to certain birds. Always move birds to another closed and well-ventilated room.

Self clean the oven before it becomes heavily soiled. Heavy soil results in longer cleaning and more smoke.

Keep the kitchen well-ventilated during the Self Cleaning cycle to help get rid of heat, odors, and smoke.

Do not block the oven vent(s) during the Self Cleaning cycle. Air must be able to move freely. See the "Oven Vents" section.

Do not clean, rub, damage, or move the oven door gasket. The door gasket is essential for a good seal.

Prepare Oven:

- Remove the broiler pan, grid, cookware and bakeware.
- Remove oven racks to keep them shiny and easy to slide. See the "General Cleaning" section for more information.
- Remove any foil from the oven because it may burn or melt, damaging the oven.
- Hand clean inside door edge and the 1 1/2" (3.8 cm) area around the inside oven cavity frame, being certain not to move or bend the gasket. This area does not get hot enough during high-temp self cleaning to remove soil. Do not let water, cleaner, etc., enter slots on door frame. Use a damp cloth to clean this area.
- Wipe out any loose soil to reduce smoke and avoid damage. At high temperatures, foods react with porcelain. Staining, etching, pitting, or faint white spots can result. This is normal and will not affect cooking performance.

IMPORTANT: Before starting self clean, switch remote control to OFF by selecting the dedicated button on the control panel. For Double Oven, the self-clean feature is only available in the upper oven.

How the Cycle Works

IMPORTANT: The heating and cooling of porcelain on steel in the oven may result in discoloring, loss of gloss, hairline cracks, and popping sounds.

The Self Cleaning cycle uses very high temperatures, burning soil to a powdery ash.

Suggested clean times are 1 hour and 15 minutes for light soil, 1 hour and 40 minutes for medium soil and 2 hours for heavy soil.

Once the oven has completely cooled, remove ash with a damp cloth. To avoid breaking the glass, do not apply a cool damp cloth to the inner door glass before it has completely cooled.

The oven lights will not work during the Self Cleaning cycle.

NOTE: The oven has a two-speed cooling fan motor. During the Self Cleaning cycle, the fan(s) will operate at its highest speed to increase airflow to better exhaust the hotter air through the oven vent(s). An increase in noise may be noticeable during and after the Self Cleaning cycle until the oven cools.

Before Self Cleaning, make sure the door is closed completely or it will not lock and the cycle will not begin. When the oven is locked, the doors of the oven cannot be opened. To avoid damage to the doors, do not force the doors open when the oven is locked.

1. Touch the Settings keypad.
2. Select the Self Clean icon.
3. Select type of Self Cleaning:
Light: 1 hour and 15 minutes
Medium: 1 hour and 40 minutes
Heavy: 2 hours
4. Follow the prompts on the oven display to prepare the oven.
5. Select START to begin the cleaning process.

OR

Select DELAY START to set a delayed Self Cleaning cycle. See the "To Delay Start Self Cleaning Cycle" Section.

The oven doors will automatically lock.

NOTE: It may take a couple moments for the oven door to automatically lock after starting the Self Clean Cycle.

When the self cleaning cycle is complete and the oven cools, the oven doors will unlock.

6. After the cleaning cycle, it may take some time for oven to cool down and unlock.

To Delay Start Self Cleaning Cycle:

Follow steps 1 through 4 above, then:

1. Select DELAY START.
2. Select the start time of when the Self Cleaning cycle should begin by scrolling from left to right.
3. Select START DELAY.
The oven doors will automatically lock after the Delay Start countdown.
When the Self Cleaning cycle is complete and the oven cools, the oven doors will unlock.
4. When the oven is completely cooled, remove ash with a damp cloth.

To Stop Self Cleaning Anytime:

Touch the Oven Cancel Keypad. If the oven temperature is too high, the door will remain locked. It will not unlock until the oven cools.

General Cleaning

IMPORTANT: Before cleaning, make sure all controls are off and the oven is cool. Always follow label instructions on cleaning products. For additional information, you can visit the Frequently Asked Questions (FAQs) section of our website at www.whirlpool.com. In Canada, refer to the Customer Service section at www.whirlpool.ca.

Soap, water, and a soft cloth or sponge are suggested first unless otherwise noted.

EXTERIOR PORCELAIN ENAMEL SURFACES (on some models)

Food spills containing acids, such as vinegar and tomato, should be cleaned as soon as the entire oven is cool. These spills may affect the finish.

Cleaning Method:

- Glass cleaner, mild liquid cleaner or nonabrasive scrubbing pad:
Gently clean around the model/serial/rating plate because scrubbing may remove numbers.
- Affresh® Kitchen and Appliance Cleaner Part Number W10355010 (not included):
See the “Accessories” section for more information.

STAINLESS STEEL (on some models)

NOTE: To avoid damage to stainless steel surfaces, do not use soap-filled scouring pads, chlorine bleach, abrasive cleaners, steel-wool pads, gritty washcloths or abrasive paper towels. Damage may occur to stainless steel surfaces, even with one-time or limited use.

Cleaning Method:

Rub in direction of grain to avoid damaging.

- Affresh® Stainless Steel Cleaner Part Number W10355016:
See the “Accessories” section for more information.

METALLIC PAINT (on some models)

Do not use abrasive cleaners, cleaners with bleach, rust removers, ammonia or sodium hydroxide (lye) because paint surface may stain.

CONTROL PANEL AND OVEN DOOR EXTERIOR

To avoid damage, do not use abrasive cleaners, steel-wool pads, gritty washcloths, or abrasive paper towels.

Cleaning Method:

- Glass cleaner and soft cloth or sponge:
Apply glass cleaner to soft cloth or sponge, not directly on panel.
- Affresh® Kitchen and Appliance Cleaner (not included): To order, visit our website at www.whirlpool.com.

OVEN RACKS

Cleaning Method:

- Steel-wool pad
- For racks that have discolored and are harder to slide, a light coating of vegetable oil applied to the rack guides will help them slide.

OVEN CAVITY AND OVEN DOOR INTERIOR

Do not use oven cleaners.

Food spills should be cleaned after the oven cools. At high temperatures, foods react with porcelain and staining, etching, pitting, or faint white spots can result.

Cleaning Method:

- Self Cleaning cycle:
See the “Self Cleaning Cycle” section first.
- For optimal door cleaning results, wipe away any deposits with a damp sponge before running cycle.

Oven Lights

The oven light(s) are standard 25 W appliance bulbs.

Before replacing, make sure the oven is cool and the controls are turned off.

To Replace:

1. Disconnect power.
2. Open oven door.
3. Remove the sliding runners (if present), then remove the shelf guides.
4. Use a screwdriver to pry off the light cover.
5. Replace the light bulb.
6. Place the light cover back in place. Push firmly until it snaps into position.
7. Refit the shelf guides.
8. Reconnect power.

TROUBLESHOOTING

First try the solutions suggested here. If you need further assistance or more recommendations that may help you avoid a service call, refer to the warranty, or visit producthelp.whirlpool.com. In Canada, visit www.whirlpool.ca.

Contact us by mail with any questions or concerns at the address below:

In the U.S.A.:

Whirlpool Brand Home Appliances
Customer eXperience Center
553 Benson Road
Benton Harbor, MI 49022-2692

In Canada:

Whirlpool Brand Home Appliances
Customer eXperience Centre
200 – 6750 Century Ave.
Mississauga, Ontario L5N 0B7

Please include a daytime phone number in your correspondence.

PROBLEM	POSSIBLE CAUSES AND/OR SOLUTIONS
Nothing will operate	Household fuse is blown, or a circuit breaker is tripped: Replace the fuse or reset the circuit breaker. If the problem continues, call an electrician.
Oven will not operate	Control Lock is on: “Control Lock” will display on the screen. Scroll up to unlock. On double oven models, one oven is self cleaning: When one oven is self cleaning, the other oven cannot be set or turned on.
Display shows messages	Power failure: On some models, reset the clock if needed. See “Preferences” in the “Settings” section. Error code (display shows letter followed by number): Press the oven Cancel keypad to clear the display. If it reappears, call for service. See the “Warranty” for contact information. Demo Mode (product is in Demo Mode): To Exit Demo Mode: <ol style="list-style-type: none"> 1. Select TRY THE PRODUCT. 2. Select the Settings keypad. 3. Scroll and select INFO. 4. Select STORE DEMO MODE and select OFF. 5. Select YES on the confirmation screen.
Clean cycle did not work on all spills	Several cooking cycles between Clean cycles or spills on oven walls and doors: Run additional Clean cycles. The affresh® Kitchen and Appliance Cleaner can be used for stubborn soils. See the “Accessories” and “Self Cleaning Cycle” sections for more information.
Warm air coming from oven vent	Warm air coming from the oven vent is normal. During a self clean cycle, the air stream is increased. The cooling fan may operate both during an oven’s cycle and after the cycle has ended, causing warm air to exit from the oven vent.
Long preheat times	Not all cycles require preheating. See cycle instructions for preheat recommendations. Most cycles preheat to 350°F (177°C) in 6 minutes. Higher temperatures will take more time. Removing unused oven racks prior to preheating can help reduce preheat time.
Self Cleaning cycle will not operate	The oven door is open: Close the oven door all the way. The function has not been entered: See the “Self Cleaning Cycle” section. A Timed Self Clean cycle has been set: See the “Self Cleaning Cycle” section.
Oven cooking results not what expected	The set temperature was incorrect: Double-check the recipe in a reliable cookbook. Oven was not preheated: See the “Baking and Roasting” section. Racks were positioned improperly: See the “Positioning Racks and Bakeware” section. Not enough air circulation around bakeware: See the “Positioning Racks and Bakeware” section. Batter distributed unevenly in pan: Check that batter is level in the pan. Darker browning of food caused by dull or dark bakeware: Lower the oven temperature 25°F (15°C) or move rack to a higher position in the oven. Lighter browning of food caused by shiny or light colored bakeware: Move rack to a lower position in the oven. Incorrect length of cooking time was used: Adjust cooking time. Oven door was not closed: Be sure that the bakeware does not keep the door from closing. Oven door was opened during cooking: Oven peeking releases oven heat and can result in longer cooking times. Rack is too close to bake burner, making baked items too brown on bottom: Move rack to higher position in the oven. Pie crusts browning too quickly: Use aluminum foil to cover the edge of the crust and/or reduce baking temperature. Remote control is ON: Switch OFF the remote control selecting the dedicated control panel key pad.

ASSISTANCE OR SERVICE

If you need service

Please refer to the warranty.

If you need replacement parts

If you need to order replacement parts, we recommend that you use only factory specified parts. These factory specified parts will fit right and work right because they are made with the same precision used to build every new Whirlpool® appliance.

To locate factory specified parts in your area, call us or your nearest Whirlpool designated service center.

In the U.S.A.

Call the Whirlpool Customer eXperience Center toll-free: **1-866-698-2538** or visit our website at **www.whirlpool.com**.

Our consultants provide assistance with:

- Features and specifications on our full line of appliances.
- Installation information.
- Use and maintenance procedures.
- Repair parts sales.
- Specialized customer assistance (Spanish speaking, hearing impaired, limited vision, etc.).
- Referrals to local dealers, repair parts distributors and service companies. Whirlpool designated service technicians are trained to fulfill the product warranty and provide after-warranty service anywhere in the United States.

To locate the Whirlpool designated service company in your area, you can also look in your telephone directory Yellow Pages.

For further assistance

If you need further assistance, you can write with any questions or concerns at:

Whirlpool Brand Home Appliances
Customer eXperience Center
553 Benson Road
Benton Harbor, MI 49022-2692

Please include a daytime phone number in your correspondence.

In Canada

Call the Whirlpool Canada Customer eXperience Centre toll-free: **1-800-807-6777**, or visit our website at **www.whirlpool.ca**.

Our consultants provide assistance with:

- Use and maintenance procedures.
- Repair parts sales.
- Referrals to local dealers, repair parts distributors and service companies. Whirlpool designated service technicians are trained to fulfill the product warranty and provide after-warranty service anywhere in Canada.

For further assistance

If you need further assistance, you can write with any questions or concerns at:

Whirlpool Brand Home Appliances
Customer eXperience Centre
200 - 6750 Century Ave.
Mississauga, ON L5N 0B7

Please include a daytime phone number in your correspondence.

Accessories

To order accessories, visit our website at **www.whirlpool.com**.

Drip Tray

Order Part Number W11348808

Baking Tray

Order Part Number W11348807

24" Oven Rack

Order Part Number W11236918