

SIDE-BY-SIDE REFRIGERATOR OWNER'S MANUAL

MANUEL D'UTILISATION DU RÉFRIGÉRATEUR CÔTE À CÔTE

Table of Contents/Table des matières

REFRIGERATOR SAFETY	2	SÉCURITÉ DU RÉFRIGÉRATEUR	28
Refrigerator Safety.....	2	Sécurité du réfrigérateur.....	28
MAINTENANCE AND CARE	3	ENTRETIEN ET RÉPARATION	29
Cleaning.....	3	Nettoyage.....	29
Lights.....	4	Lampes.....	30
Freezer Shelf (number varies by model).....	5	Tablettes du congélateur (le nombre varie selon le modèle).....	31
Vacation and Moving Care.....	5	Précautions à prendre avant les vacances ou le déménagement.....	32
INSTALLATION INSTRUCTIONS	6	INSTRUCTIONS D'INSTALLATION	32
Unpack the Refrigerator.....	6	Déballage du réfrigérateur.....	32
Location Requirements.....	6	Exigences d'emplacement.....	33
Electrical Requirements.....	9	Spécifications électriques.....	35
Water Supply Requirements.....	9	Spécifications de l'alimentation en eau.....	36
Connect Water Supply.....	10	Raccordement à la canalisation d'eau.....	36
Complete the Installation.....	11	Terminer l'installation.....	38
Install Air Filter (on some models).....	12	Installer le filtre à air (sur certains modèles).....	39
Install Produce Preserver (on some models).....	12	Installation du conservateur de produits frais (sur certains modèles).....	39
REFRIGERATOR FEATURES	13	CARACTÉRISTIQUES DU RÉFRIGÉRATEUR	40
Convertible Drawer Temperature Control (on some models).....	13	Commande de température dans le tiroir convertible (sur certains modèles).....	40
Crisper Humidity Control (on some models).....	13	Commande d'humidité dans le bac à légumes (sur certains modèles).....	40
Dual Evaporator (on some models).....	13	Évaporateur double (sur certains modèles).....	41
Water and Ice Dispensers.....	14	Distributeurs d'eau et de glaçons.....	41
Ice Maker and Storage Bin.....	14	Machine à glaçons et bac d'entreposage.....	41
Water Filtration System.....	16	Système de filtration de l'eau.....	43
DOOR REMOVAL AND LEVELING STYLE 1	17	RETRAIT DE LA PORTE ET AJUSTEMENT DU NIVEAU, STYLE 1	45
Door Instructions.....	17	Instructions pour la porte.....	45
Install and Remove Door Handles.....	17	Installation et retrait des poignées de la porte.....	45
Remove Doors and Hinges.....	18	Démontage des portes et charnières.....	46
Replace Doors and Hinges.....	20	Réinstallation des portes et charnières.....	48
Door Closing and Alignment.....	21	Fermeture et alignement des portes.....	49
DOOR REMOVAL AND LEVELING STYLE 2	22	RETRAIT DE LA PORTE ET AJUSTEMENT DU NIVEAU, STYLE 2	50
Door Instructions.....	22	Instructions pour la porte.....	50
Install and Remove Door Handles.....	22	Installation et retrait des poignées de la porte.....	50
Remove Doors and Hinges.....	23	Démontage des portes et charnières.....	51
Door Closing, Leveling, and Alignment.....	25	Fermeture, mise à niveau et alignement des portes.....	53
PERFORMANCE DATA SHEET	26	FICHE DE DONNÉES DE PERFORMANCE	54
Performance Data Sheet.....	26	Fiche de données de performance.....	54

REFRIGERATOR SAFETY

Your safety and the safety of others are very important.

We have provided many important safety messages in this manual and on your appliance. Always read and obey all safety messages.



This is the safety alert symbol.

This symbol alerts you to potential hazards that can kill or hurt you and others.

All safety messages will follow the safety alert symbol and either the word "DANGER" or "WARNING." These words mean:

▲ DANGER

You can be killed or seriously injured if you don't immediately follow instructions.

▲ WARNING

You can be killed or seriously injured if you don't follow instructions.

All safety messages will tell you what the potential hazard is, tell you how to reduce the chance of injury, and tell you what can happen if the instructions are not followed.

IMPORTANT SAFETY INSTRUCTIONS

WARNING: To reduce the risk of fire, electric shock, or injury to persons when using your appliance, follow basic precautions, including the following:

- Children should be supervised to ensure that they do not play with the appliance.
- This appliance is not intended for use by persons (including children) with reduced physical, sensory, or mental capabilities, or lack of experience and knowledge, unless they have been given supervision or instruction concerning use of the appliance by a person responsible for their safety.
- Do not use an extension cord.
- If power supply cord is damaged, it must be replaced by the manufacturer, its service agent, or a similarly qualified person in order to avoid a hazard.
- Connect to potable water supply only.
- This appliance is intended to be used in household and similar applications such as: staff kitchen areas in shops, offices, and other working environments; farm houses and by clients in hotels, motels, and other residential-type environments; bed and breakfast-type environments; and catering and similar non-retail applications.
- Do not store explosive substances such as aerosol cans with a flammable propellant in this appliance.
- Do not use replacement parts that have not been recommended by the manufacturer (e.g., parts made at home using a 3D printer).
- Keep ventilation openings, in the appliance enclosure or in the built-in structure, clear of obstruction.
- Do not use mechanical devices or other means to accelerate the defrosting process, other than those recommended by the manufacturer.
- Do not damage the refrigerant circuit.
- Do not use electrical appliances inside the food storage compartments of the appliance, unless they are of the type recommended by the manufacturer.
- Ice maker kit can be added to some models. See serial tag inside the food compartment of appliance for ice maker kit model information.
- A qualified service technician must install the water line and ice maker. See installation instructions supplied with ice maker kit for complete details.

SAVE THESE INSTRUCTIONS

Proper Disposal of Your Old Refrigerator

WARNING: Risk of child entrapment. Before you throw away your old refrigerator or freezer:

- Take off the doors.
- Leave the shelves in place so that children may not easily climb inside.

⚠WARNING

Suffocation Hazard

Remove doors or lid from your old appliance.

Failure to do so can result in death or brain damage.

IMPORTANT: Child entrapment and suffocation are not problems of the past. Junked or abandoned refrigerators are still dangerous, even if they will sit for “just a few days.” If you are getting rid of your old refrigerator, please follow these instructions to help prevent accidents.

Important information to know about disposal of refrigerants:

Dispose of refrigerator in accordance with federal and local regulations. Refrigerants must be evacuated by a licensed, EPA-certified refrigerant technician in accordance with established procedures.

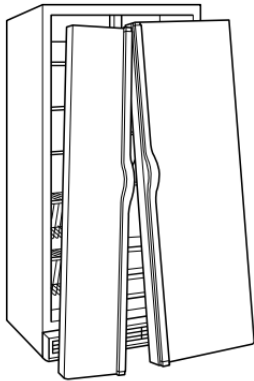

MAINTENANCE AND CARE

Cleaning

⚠WARNING



Explosion Hazard

Risk of Fire or Explosion.

Flammable Refrigerant Used.

Do Not Use Mechanical Devices to Defrost Refrigerator.

Do Not Puncture Refrigerant Tubing.

Both the refrigerator and freezer sections defrost automatically. However, clean both sections about once a month to avoid buildup of odors. Wipe up spills immediately.

IMPORTANT: Because air circulates between both sections, any odors formed in one section will transfer to the other. You must thoroughly clean both sections to eliminate odors. To avoid odor transfer and drying out of food, wrap or cover foods tightly.

NOTE: Do not use abrasive or harsh cleaners such as window sprays, scouring cleansers, flammable fluids, cleaning waxes, concentrated detergents, bleaches or cleansers containing petroleum products on plastic parts, interior, and door liners or gaskets. Do not use paper towels, scouring pads, or other harsh cleaning tools. Stainless steel models have a coating. Do Not use regular stainless steel cleaning products. Do Not use stainless steel cleaner or polish and use only mild soap, water, and soft microfiber cloth to avoid damage to the stainless steel protective coating. Paper towels scratch and may dull the clear coat of the painted door. To avoid possible damage, use only clean cloths to polish and wipe the door.

1. Unplug refrigerator or disconnect power.
2. Hand-wash, rinse, and dry removable parts and interior surfaces thoroughly. Use a clean sponge or soft cloth and a mild detergent in warm water.
3. Wash stainless steel and painted metal exteriors with a clean sponge or soft cloth and a mild detergent in warm water.

⚠WARNING



Explosion Hazard

Risk of Fire or Explosion due to Puncture of Refrigerant Tubing;

Follow Handling Instructions Carefully.

Flammable Refrigerant Used.

4. There is no need for routine condenser cleaning in normal home operating environments. If the environment is particularly greasy or dusty, or there is significant pet traffic in the home, the condenser should be cleaned every 2 to 3 months to ensure maximum efficiency.

If you need to clean the condenser:

- Remove the base grille. See the “Door Removal” instructions, either in the Owner’s Manual or in the separate instruction sheet provided with your refrigerator.
 - Use a vacuum cleaner with a soft brush to clean the grille, the open areas behind the grille, and the front surface area of the condenser.
 - Replace the base grille when finished.
5. Plug in refrigerator or reconnect power.

Lights

Not all bulbs will fit your refrigerator. Be sure to replace the bulb with one of the same size, shape, and wattage.

IMPORTANT: The light bulbs in both the refrigerator and freezer compartments of your new refrigerator may use LED technology. On some models, the LED light bulbs in the refrigerator, freezer, air tower, and dispenser cannot be changed by yourself. If the lights do not illuminate when the refrigerator and/or freezer door is opened, call for assistance or service. In the U.S.A., call **1-866-698-2538**. In Canada, call **1-800-807-6777**.

Light Styles:

The dispenser lights are LEDs that cannot be changed.

The interior lights vary by model.

- Some models have mini LEDs that cannot be changed.
- Some models have full-size LED bulbs that can be changed. To order replacement 2.0 W LED bulbs, use part number **W10574850A**, and for 3.6 W, use part number **W10565137A**, or call **1-866-698-2538** (U.S.A.) or **1-800-807-6777** (Canada).

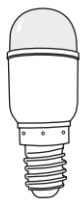

2.0 watts

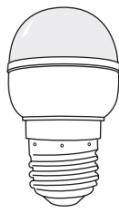

3.6 watts

NOTE: Some LED replacement bulbs are not recommended for wet/damp environments. The refrigerator and freezer compartments are considered to be wet/damp environments. If using a brand of LED bulb other than the recommended Whirlpool LED bulb, read and follow all instructions on the replacement bulb's packaging before installing it.

- Some models have interior incandescent 40 W bulbs that can be changed.

NOTE: Not all replacement bulbs will fit your refrigerator. Do not use an incandescent bulb in excess of 40 watts.



To Change a Light Bulb:

1. Unplug refrigerator or disconnect power.
2. Remove the light shield, as explained in the following sections.

NOTE: To clean the light shield, wash it with warm water and liquid detergent. Before reinstalling, thoroughly rinse and dry the shield.

3. Replace the burned-out light bulb, as explained in the following sections.
4. Reinstall the light shield, as explained in the following sections.
5. Plug in refrigerator or reconnect power.

Refrigerator Compartment – Upper Lights

Light Shield Removal:

Slide the light shield toward the rear of the refrigerator and remove it from the light housing.

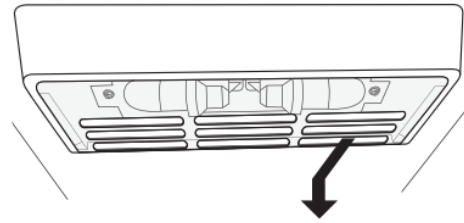

Replacement Bulb:

- If the burned-out light is a full-size LED bulb, replace it with a 2.0 W LED bulb.
- If the burned-out light is an incandescent bulb, replace it with an incandescent appliance bulb of the same size, shape, and wattage (40 W maximum).

Light Shield Reinstallation:

Align the light shield in the grooves at the bottom edge of the light housing; then slide it forward until it snaps into place.

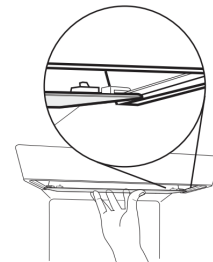

Refrigerator Compartment – Lower Lights

Light Shield Removal:

Slide the light shield to the right to remove the left end from the wall slots; then pull the right end out of its wall slots.

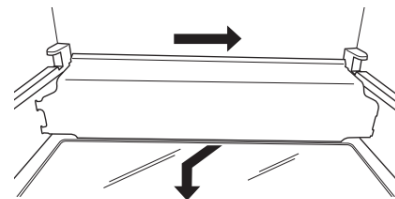

Replacement Bulb:

- If the burned-out light is a full-size LED bulb, replace it with a 3.6 W LED bulb.
- If the burned-out light is an incandescent bulb, replace it with an incandescent appliance bulb of the same size, shape, and wattage (40 W maximum).

Light Shield Reinstallation:

Place the right end of the light shield into the wall slots; then snap the left end into its wall slots.

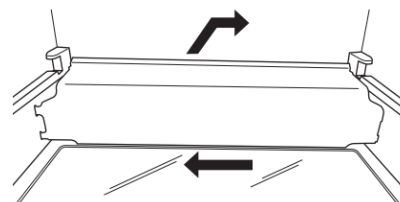

Freezer Compartment – Upper Light Light Shield Removal:

Gently squeeze the front and the bottom-rear edge of the light shield to release the tabs from the wall slots; then pull the light shield forward.

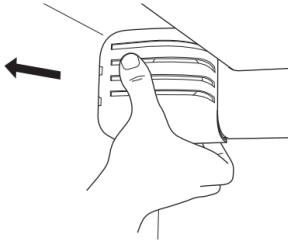

Replacement Bulb:

- If the burned-out light is a full-size LED bulb, replace it with a 3.6 W LED bulb.
- If the burned-out light is an incandescent bulb, replace it with an incandescent appliance bulb of the same size, shape, and wattage (40 W maximum).

Light Shield Reinstallation:

Align the light shield in its proper position, and snap the tabs into the wall slots.

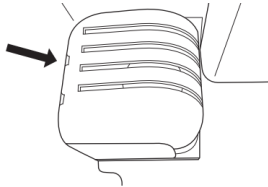

Freezer Compartment – Lower Light Light Shield Removal:

Slide the light shield to the left to remove the right end from the wall slots; then pull the left end out of its wall slots.

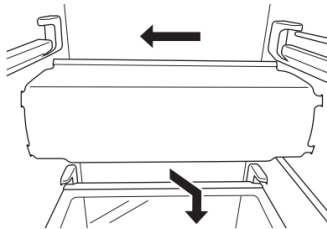

Replacement Bulb:

- If the burned-out light is a full-size LED bulb, replace it with a 3.6 W LED bulb.
- If the burned-out light is an incandescent bulb, replace it with an incandescent appliance bulb of the same size, shape, and wattage (40 W maximum).

Light Shield Reinstallation:

Place the left end of the light shield into the wall slots; then snap the right end into its wall slots.

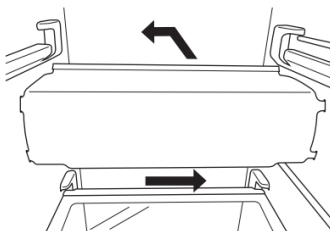

Freezer Shelf (number varies by model)

To Remove and Replace the Bottom Shelf:

1. Lift up the front and back of the shelf, and remove from the cabinet. Be sure not to remove the retaining rods.
2. Replace the shelf, aligning the rods with the cabinet ribs. Apply a little pressure on the shelf to attach the rods to the ribs of the cabinet.

To Remove and Replace the Mid and Top Shelf:

1. With your hand, push the shelf from bottom to top until it is released from the holding rod. Pull the shelf until it is released from the rear rod. Remove from the cabinet.
2. To replace the shelf:
 - Replace rods into the support holes. Push the rods down so they click into the holes.
 - Identify the front and rear trim of the shelf.

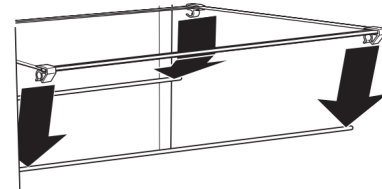

- Place the rear trim on the rear rod and push the shelf so it clicks the rod into the rear trim. (Keep the front raised while pushing.)
- Lower the front of the shelf until the front trim is on the rod and push the shelf down so it clicks the rod into the front trim.

NOTE: Be sure that both sides of the shelf are positioned evenly in the shelf support holes and the shelf is secure.

Vacation and Moving Care

Vacations

If You Choose to Leave Refrigerator On While You Are Away:

1. Use up any perishables and freeze other items.
2. If your refrigerator has an automatic ice maker and is connected to the household water supply, turn off the water supply to the refrigerator. Property damage can occur if the water supply is not turned off.
3. If you have an automatic ice maker, turn off the ice maker.

NOTE: Depending on your model, raise the wire shut-off arm to Off (up) position or press the switch to Off.

4. Empty the ice bin.

If You Choose to Turn Refrigerator Off Before You Leave:

1. Remove all food from the refrigerator.
2. If your refrigerator has an automatic ice maker:
 - Turn off the water supply to the ice maker at least one day ahead of time.
 - When the last load of ice drops, raise the wire shut-off arm to the Off (up) position or move the switch to the Off setting.
3. Depending on the model, turn the refrigerator control to Off or turn cooling off. See "Control Descriptions" in the Quick Start Guide.
4. Unplug refrigerator or disconnect power.
5. Clean, wipe, and dry thoroughly.
6. Tape rubber or wood blocks to the tops of both doors to prop them open far enough for air to get in. This stops odor and mold from building up.

Moving

When you are moving your refrigerator to a new home, follow these steps to prepare it for the move.

1. If your refrigerator has an automatic ice maker:
 - Turn off the water supply to the ice maker at least one day ahead of time.
 - Disconnect the water line from the back of the refrigerator.
 - When the last load of ice drops, raise the wire shut-off arm to the Off (up) position or move the switch to the Off setting.
2. Remove all food from the refrigerator and pack all frozen food in dry ice.
3. Empty the ice bin.
4. Depending on the model, turn the refrigerator control to Off or turn cooling off. See "Control Descriptions" in the Quick Start Guide.
5. Unplug refrigerator or disconnect power.
6. Clean, wipe, and dry thoroughly.
7. Take out all removable parts, wrap them well, and tape them together so they don't shift and rattle during the move.
8. Depending on the model, raise the front of the refrigerator so it rolls more easily, or screw in the leveling legs so they don't scrape the floor. See "Adjust the Doors" or "Door Removal, Leveling and Alignment" in the online Feature Guide.
9. Tape the doors closed and tape the power cord to the back of the refrigerator.

When you get to your new home, put everything back and refer to the Installation Instructions for preparation instructions. Also, if your refrigerator has an automatic ice maker, remember to reconnect the water supply to the refrigerator.

INSTALLATION INSTRUCTIONS

Unpack the Refrigerator

⚠WARNING

Excessive Weight Hazard

Use two or more people to move and install or uninstall appliance.

Failure to do so can result in back or other injury.

Remove the Packaging

Dispose of/recycle all packaging materials. Do not use sharp instruments, rubbing alcohol, flammable fluids, or abrasive cleaners to remove tape or glue. These products can damage the surface of your refrigerator. For more information, see "Refrigerator Safety."

When Moving Your Refrigerator:

Your refrigerator is heavy. When moving the refrigerator for cleaning or service, be sure to cover the floor with cardboard or hardboard to avoid floor damage. Always pull the refrigerator straight out when moving it. Do not wiggle or "walk" the refrigerator when trying to move it, as floor damage could occur.

IMPORTANT:

- For counter-depth models, use 1/2" socket wrench to remove skids (socket extension is recommended).
- All four leveling legs must contact the floor to support and stabilize the full weight of the refrigerator.

Clean Before Using

After you remove all of the package materials, clean the inside of your refrigerator before using it. See the "Cleaning" section in this manual.

Important information to know about glass shelves and covers:

Do not clean glass shelves or covers with warm water when they are cold. Shelves and covers may break if exposed to sudden temperature changes or impact, such as bumping. Tempered glass is designed to shatter into many small, pebble-size pieces. This is normal. Glass shelves and covers are heavy. Use both hands when removing them to avoid dropping.

Location Requirements

⚠WARNING



Explosion Hazard

Keep flammable materials and vapors, such as gasoline, away from appliance.

Use nonflammable cleaner.

Failure to do so can result in death, explosion, or fire.

IMPORTANT:

- This refrigerator is designed for indoor household use only.
- Observe all governing codes and ordinances.
- **Installer:** Leave Owner's Manual with homeowner.
- **Homeowner:** Keep Owner's Manual for future reference and for the local electrical inspector's use.
- Keep cardboard shipping piece or plywood under refrigerator until it is installed in the operating position.
- Comply with installation specifications and dimensions.
- Remove any moldings or decorative panels from kitchen cabinets that would not allow access to the refrigerator for service.
- Contact a qualified electrical installer.

For Standard Side-by-Side Installation:

To ensure proper ventilation for your refrigerator, allow for 1/2" (1.27 cm) of space on each side and at the top. Allow for 2" (5.08 cm) of space behind the refrigerator. If your refrigerator has an ice maker, allow extra space at the back for the water line connections. When installing your refrigerator next to a fixed wall, leave a 2" (5.08 cm) minimum space on each side (depending on your model) to allow the doors to swing open.

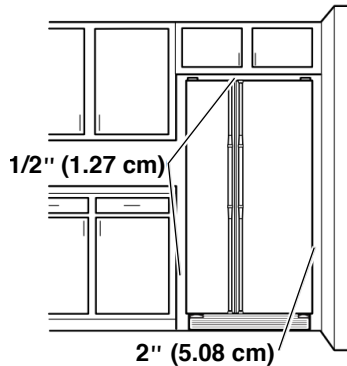

NOTES:

- This refrigerator is intended for use in a location where the temperature ranges from a minimum of 55°F (13°C) to a maximum of 110°F (43°C). The preferred room temperature range for optimum performance, which reduces electricity usage and provides superior cooling, is between 60°F (15°C) and 90°F (32°C). It is recommended that you do not install the refrigerator near a heat source, such as an oven or radiator.
- Normal minimum cabinet cut-out width required for product installation is 36" (91.44 cm). However, if the product is placed against an extended wall and the ability to remove the crisper pans is desired, an additional 18" (45.72 cm) of cabinet width is required, so a total cabinet opening width of 54" (137.16 cm) is recommended.

For Counter-Depth Side-by-Side Installation:

NOTES:

- The refrigerator can be installed into a recessed opening, at the end of cabinets or as a freestanding refrigerator.
- If you are installing the refrigerator to fit flush with the front of the base cabinets, all shoe moulding and baseboards must be removed from the rear of the refrigerator opening. Allow for 1" (2.54 cm) of space behind the refrigerator.
- Location should permit doors to open fully. See "Product Dimensions."
- This refrigerator is intended for use in a location where the temperature ranges from a minimum of 55°F (13°C) to a maximum of 110°F (43°C). The preferred room temperature range for optimum performance, which reduces electricity usage and provides superior cooling, is between 60°F (15°C) and 90°F (32°C). It is recommended that you do not install the refrigerator near a heat source, such as an oven or radiator.
- Floor must support refrigerator weight (more than 600 lbs. [272 kg]) and contents.

Tools Needed:

Gather the required tools and parts before starting installation. Read and follow the instructions provided with any tools listed here.

- Cordless drill
- 1/4" nut driver and drill bit
- Flat-blade screwdriver
- Two adjustable wrenches
- 5/16" or adjustable wrench
- 7/16" and 1/2" open-end wrenches
- 3/8" and 1/2" socket wrenches

Parts Needed:

- Your refrigerator dealer has a kit available with a 1/4" (6.35 mm) saddle-type shut-off valve, a union, and copper tubing.
- Or you can purchase 1/4" (6.35 mm) copper tubing with shut-off valve and a 1/4" (6.35 mm) compression fitting (coupling).
- Depending on water line connections, you may also need a 1/4" (6.35 mm) nut and 1/4" (6.35 mm) ferrule.

Product Dimensions – Top View

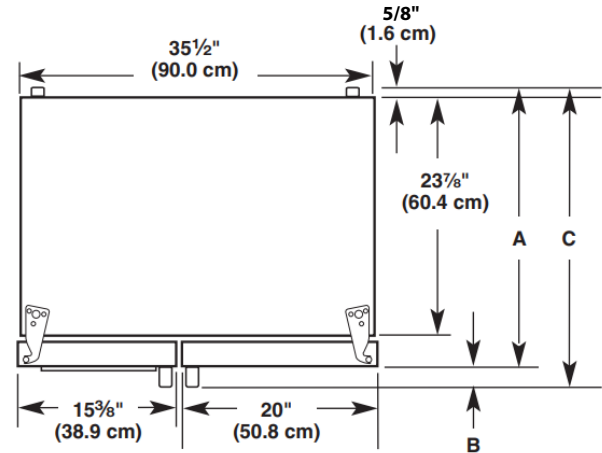

Door Style	Depth A	Depth B	Depth C
Flat	27 1/2" (69.9 cm)	2 5/8" (6.7 cm) maximum*	30" (76.2 cm) maximum*
Curved	28 5/8" (72.7 cm)	2 5/8" (6.7 cm)	31 1/8" (79.1 cm)

*Dimension may vary based on style of door handle. The depth for the largest available handle is listed.

Product Dimensions – Front View

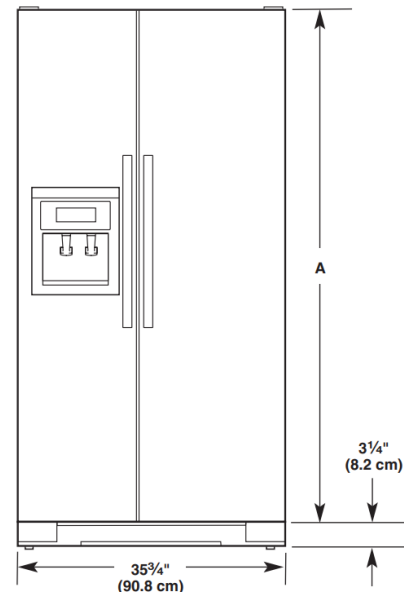

Model Size	Height A
69"	65 3/4" (167.0 cm)
72"	68 1/8" (173.0 cm)

Product Dimensions – Side View

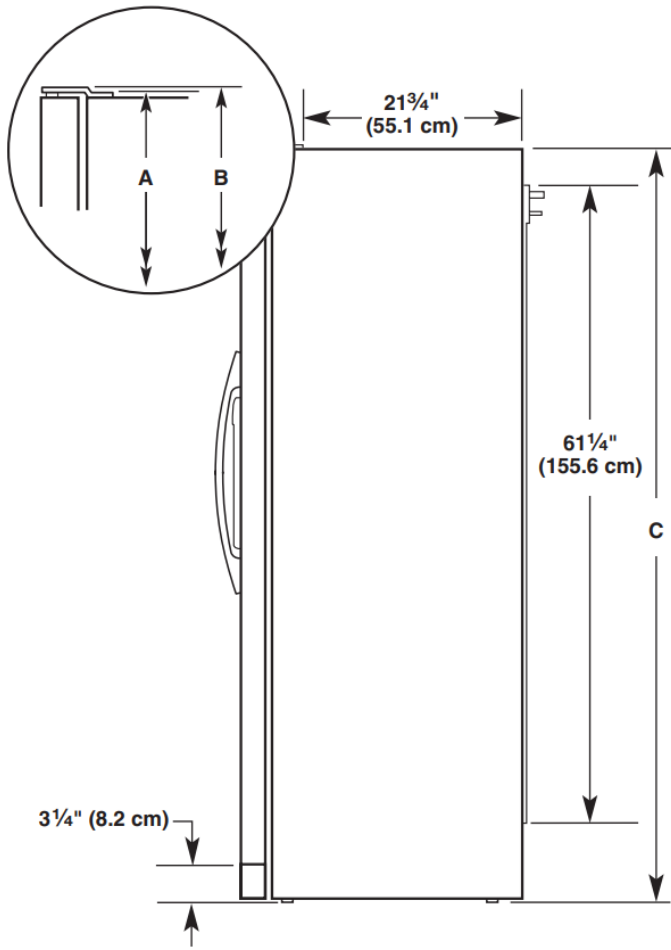

- Height dimensions are shown with the leveling legs extended to the minimum height of 1/4" (6.35 mm) below the refrigerator.
NOTE: When leveling legs are fully extended to 1" (25 mm) below the refrigerator, add 3/4" (19 mm) to the height dimensions.
- The power cord is 61 1/4" (155.6 cm) long.
- The water line attached to the back of the refrigerator is 78" (198.1 cm) long.

Model Size	Height A	Height B	Height C
69"	68 7/8" (174.9 cm)	68 7/8" (174.9 cm)	68 1/2" (174.0 cm)
72"	71 1/4" (181.0 cm)	71 1/4" (181.0 cm)	71" (180.3 cm)

Opening Dimensions

- Height dimensions are shown with the leveling legs extended to the minimum height of 1/4" (6.35 mm) below the refrigerator.
NOTE: When leveling legs are fully extended to 1" (25 mm) below the refrigerator, add 3/4" (19 mm) to the height dimensions.
- In the following graphic, "A" represents the opening height required for standard cabinets. For full-overlay cabinet doors with a trim kit, add 1/8" (0.3 cm).
- In the following graphic, "B" represents the distance needed to fully open the freezer door and "C" represents the distance needed to fully open the refrigerator door.

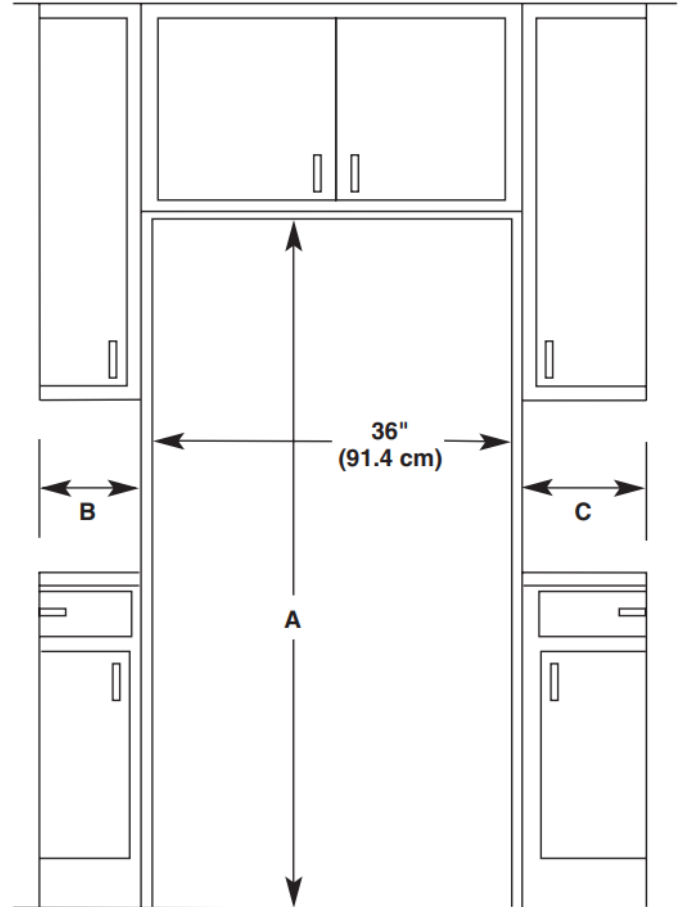

Model Size and Door Style	Height A	Width B	Width C
69" Flat	69" (175.3 cm)	13 5/8" (34.6 cm) maximum*	18 1/8" (46.0 cm) maximum*
72" Flat	72" (182.9 cm)	13 1/4" (181.0 cm) maximum*	18 1/8" (46.0 cm) maximum*
69" Curved	69" (175.3 cm)	13 5/8" (34.6 cm)	18 3/8" (46.7 cm)
72" Curved	72" (182.9 cm)	13 3/4" (34.9 cm)	18 3/8" (46.7 cm)

*Dimension may vary based on style of door handle. The width for the largest available handle is listed.

Door Swing Dimensions

- Location must permit doors to open to a minimum of 165°.
- In the following graphic, "A" represents the distance needed to fully open the freezer door and "B" represents the distance needed to fully open the refrigerator door.

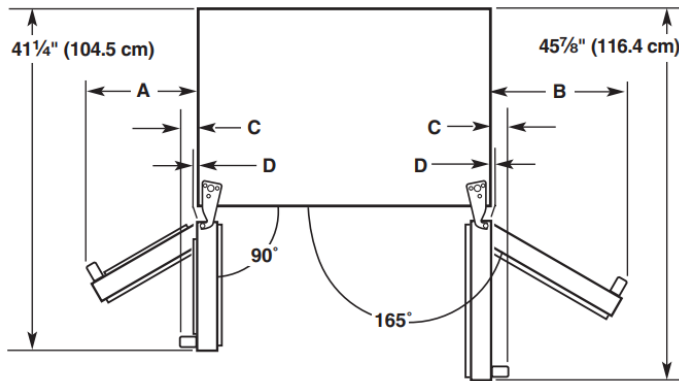

Dimension	Flat Doors	Curved Doors
A	13 ⁵ / ₈ " (34.6 cm) maximum*	13 ³ / ₄ " (34.9 cm)
B	18 ¹ / ₈ " (46.0 cm) maximum*	18 ³ / ₈ " (46.7 cm)
C	2 ³ / ₄ " (7.0 cm) maximum*	3 ³ / ₄ " (9.5 cm)
D	1/8" (0.3 cm)	1/4" (3.2 cm)

*Dimension may vary based on style of door handle. The width for the largest available handle is listed.

Electrical Requirements

⚠ WARNING



Electrical Shock Hazard

- Plug into a grounded 3 prong outlet.
- Do not remove ground prong.
- Do not use an adapter.
- Do not use an extension cord.
- Failure to follow these instructions can result in death, fire, or electrical shock.

Before you move your refrigerator into its final location, it is important to make sure you have the proper electrical connection.

Recommended Grounding Method

A 115 V, 60 Hz AC-only, 15 A or 20 A fused, grounded electrical supply is required. It is recommended that a separate circuit serving only your refrigerator be provided. Use an outlet that cannot be turned off by a switch. Do not use an extension cord.

NOTE: Before performing any type of installation, cleaning, or removing a light bulb, turn cooling off or turn the control (thermostat, refrigerator, or freezer control depending on the model) to Off. Then disconnect the refrigerator from the electrical source. When you are finished, reconnect the refrigerator to the electrical source. Turn cooling on or reset the control (thermostat, refrigerator, or freezer control depending on the model) to the desired setting. See "Control Descriptions" in the Quick Start Guide.

Water Supply Requirements

Gather the required tools and parts before starting installation. Read and follow the instructions provided with any tools listed here.

Tools Needed:

- Flat-blade screwdriver
- 1/4" nut driver
- 7/16" and 1/2" open-end or two adjustable wrenches
- 1/4" drill bit
- Cordless drill

NOTE: Your refrigerator dealer has a kit available with a 1/4" (6.35 mm) saddle-type shut-off valve, a union, and copper or PEX tubing. Before purchasing, make sure a saddle-type valve complies with your local plumbing codes. Do not use a piercing-type or 3/16" (4.76 mm) saddle valve, which reduces water flow and clogs more easily.

IMPORTANT:

- All installations must meet local plumbing code requirements.
- Use copper or PEX tubing and check for leaks. Install copper or PEX tubing only in areas where the household temperatures will remain above freezing.

Water Pressure

A cold water supply with water pressure of between 30 psi and 120 psi (207 kPa and 827 kPa) is required to operate the water dispenser and ice maker. If you have questions about your water pressure, call a licensed, qualified plumber.

If your refrigerator has a water dispenser: After installation is complete, use the water dispenser to check the water pressure.

- With the water filter removed, dispense 1 cup (237 mL) of water. If 1 cup of water is dispensed in 8 seconds or less, the water pressure to the refrigerator meets the minimum requirement.
- If it takes longer than 8 seconds to dispense 1 cup of water, the water pressure to the refrigerator is lower than recommended. See online "Troubleshooting" for suggestions.

Reverse Osmosis Water Supply

IMPORTANT: The pressure of the water supply coming out of a reverse osmosis system going to the water inlet valve of the refrigerator needs to be between 30 psi and 120 psi (207 kPa and 827 kPa).

If a reverse osmosis water filtration system is connected to your cold water supply, the water pressure to the reverse osmosis system needs to be a minimum of 40 to 60 psi (276 to 414 kPa).

If the water pressure to the reverse osmosis system is less than 40 psi to 60 psi (276 kPa to 414 kPa):

- Check to see whether the sediment filter in the reverse osmosis system is blocked. Replace the filter if necessary.
- Allow the storage tank on the reverse osmosis system to refill after heavy usage.
- If your refrigerator has a water filter, it may further reduce the water pressure when used in conjunction with a reverse osmosis system. Remove the water filter. See "Water Filtration System".

If you have questions about your water pressure, call a licensed, qualified plumber.

Connect Water Supply

Read all directions before you begin.

IMPORTANT:

- Connect to potable water supply only.
- Plumbing shall be installed in accordance with the International Plumbing Code and any local codes and ordinances.
- The gray water tubing on the back of the refrigerator (which is used to connect to the household water line) is a PEX (cross-linked polyethylene) tube. Copper or PEX tubing connections from the household water line to the refrigerator are acceptable, and will help avoid off-taste or odor in your ice or water. Check for leaks. For recommended parts if PEX tubing is used instead of copper:
W10505928RP (7 ft [2.14 m] jacketed PEX),
8212547RP (5 ft [1.52 m] PEX), or
W10267701RP (25 ft [7.62 m] PEX).
- Install tubing only in areas where temperatures will remain above freezing.

Tools Needed:

Gather the required tools and parts before starting installation. Read and follow the instructions provided with any tools listed here.

- Flat-blade screwdriver
- 7/16" and 1/2" open-end wrenches or two adjustable wrenches
- 1/4" nut driver

Connect to Water Line

IMPORTANT: If you turn on the refrigerator before the water line is connected, turn off the ice maker.

Style 1 (Recommended)

1. Unplug refrigerator or disconnect power.
2. Turn off main water supply. Turn on nearest faucet long enough to clear line of water.
3. Use a quarter-turn shut-off valve or the equivalent, served by a 1/2" copper or PEX household supply line.

NOTE: To allow sufficient water flow to the refrigerator, a minimum 1/2" size copper or PEX household supply line is recommended.

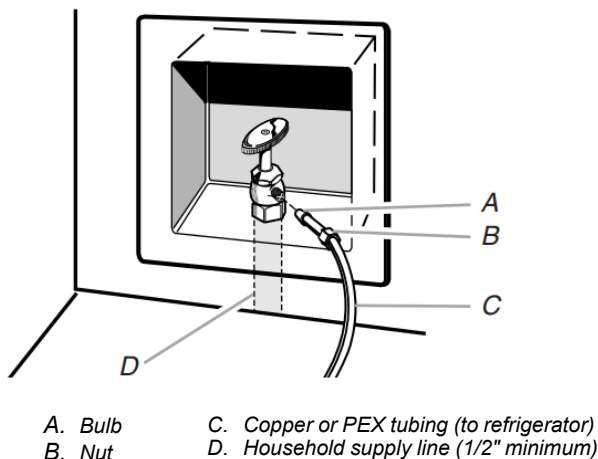

4. Now you are ready to connect the copper or PEX tubing to the shut-off valve. Use 1/4" (6.35 mm) O.D. (outside diameter) soft copper or PEX tubing to connect the shut-off valve and the refrigerator.
 - Ensure that you have the proper length needed for the job. Be sure both ends of the copper tubing are cut square.
 - Slip compression sleeve and compression nut onto copper tubing as shown. (PEX tubing has compression sleeves and compression nuts preinstalled.) Insert end of tubing into outlet end squarely as far as it will go. Screw compression nut onto outlet end with adjustable wrench. Do not overtighten.

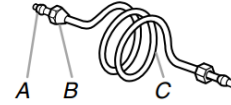

- A. Compression sleeve
B. Compression nut
C. Copper or PEX tubing

5. Place the free end of the tubing into a container or sink, and turn on main water supply to flush out tubing until water is clear. Turn off shut-off valve on the water pipe.

NOTE: Always drain the water line before making the final connection to the inlet of the water valve, to avoid possible water valve malfunction.
6. Bend the copper or PEX tubing to meet the water line inlet, which is located on the back of the refrigerator cabinet. Leave a coil of copper or PEX tubing to allow the refrigerator to be pulled out of the cabinet or away from the wall for service.

Style 2

1. Unplug refrigerator or disconnect power.
2. Turn off main water supply. Turn on nearest faucet long enough to clear line of water.
3. Locate a 1/2" (1.27 cm) to 1 1/4" (3.18 cm) vertical cold water pipe near the refrigerator.

IMPORTANT:

 - Make sure it is a cold water pipe.
 - Horizontal pipe will work, but drill on the top side of the pipe, not the bottom. This will help keep water away from the drill and normal sediment from collecting in the valve.
4. Determine the length of copper or PEX tubing you need. Measure from the connection on the lower rear corner of refrigerator to the water pipe. Add 7 ft (2.1 m) to allow for cleaning. Use 1/4" (6.35 mm) O.D. (outside diameter) copper or PEX tubing. Be sure both ends of copper or PEX tubing are cut square.
5. Using a cordless drill, drill a 1/4" (6.35 mm) hole in the cold water pipe you have selected.

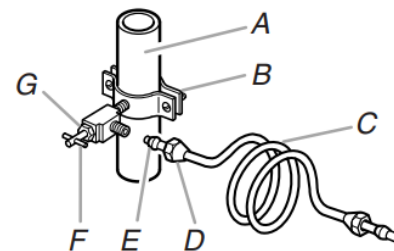

- A. Cold water pipe
B. Pipe clamp
C. Copper or PEX tubing
D. Compression nut
E. Compression sleeve
F. Shut-off valve
G. Packing nut

- Fasten the shut-off valve to the cold water pipe with the pipe clamp. Be sure the outlet end is solidly in the 1/4" (6.35 mm) drilled hole in the water pipe and that the washer is under the pipe clamp. Tighten the packing nut. Tighten the pipe clamp screws slowly and evenly so the washer makes a watertight seal. Do not overtighten, or you may crush the copper or PEX tubing.
- Slip compression sleeve and compression nut onto copper tubing as shown. (PEX tubing has compression sleeves and compression nuts preinstalled.) Insert end of tubing into outlet end squarely as far as it will go. Screw compression nut onto outlet end with adjustable wrench. Do not overtighten.
- Place the free end of the tubing in a container or sink, and turn on the main water supply. Flush the tubing until water is clear. Turn off the shut-off valve on the water pipe. Coil the tubing.

Connect to Refrigerator

Style 1

- Unplug refrigerator or disconnect power.
- Remove and discard the short, black plastic part from the end of the water line inlet.
- Thread the nut onto the end of the tubing. Tighten the nut by hand. Then tighten it with a wrench two more turns. Do not overtighten.

NOTE: To avoid rattling, be sure the copper tubing does not touch the cabinet's side wall or other parts inside the cabinet.

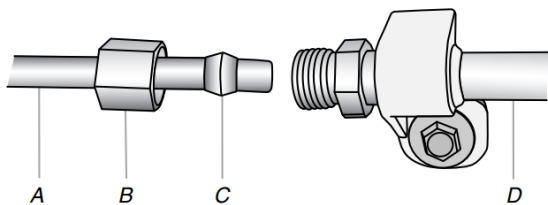

A. Household water line
B. Nut (purchased)
C. Ferrule (purchased)
D. Refrigerator water tubing

- Install the water supply tube clamp around the water supply line to reduce strain on the coupling.
- Turn shut-off valve on.
- Check for leaks. Tighten any connections (including connections at the valve) or nuts that leak.

Style 2

- Unplug refrigerator or disconnect power.
- Remove and discard the plastic part that is attached to the inlet of the water valve.
- Attach the copper or PEX tube to the valve inlet using a compression nut and sleeve as shown. Tighten the compression nut. Do not overtighten.

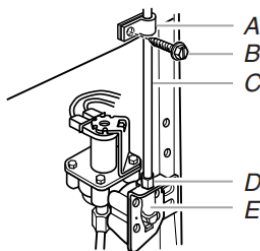

A. Tube clamp
B. Tube clamp screw
C. Copper tubing
D. Compression nut
E. Valve inlet

- Use the tube clamp on the back of the refrigerator to secure the tubing to the refrigerator as shown. This will help avoid damage to the tubing when the refrigerator is pushed back against the wall.
- Turn shut-off valve on.
- Check for leaks. Tighten any connections (including connections at the valve) or nuts that leak.
- On some models, the ice maker is equipped with a built-in water strainer. If your water conditions require a second water strainer, install it in the 1/4" (6.35 mm) water line at either tube connection. Obtain a water strainer from your nearest appliance dealer.

Style 3

- Unplug refrigerator or disconnect power.
- Remove and discard the black nylon plug from the gray water tube on the rear of the refrigerator.
- If the gray water tube supplied with the refrigerator is not long enough, a 1/4" x 1/4" (6.35 mm x 6.35 mm) coupling is needed in order to connect the water tubing to an existing household water line. Thread the provided nut onto the coupling on the end of the copper or PEX tubing.

NOTE: Tighten the nut by hand. Then tighten it with a wrench two more turns. Do not overtighten.

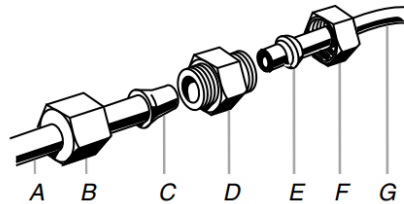

A. Refrigerator water tubing
B. Nut (provided)
C. Bulb
D. Coupling (purchased)
E. Ferrule (purchased)
F. Nut (purchased)
G. Household water line

- Turn shut-off valve on.
- Check for leaks. Tighten any connections (including connections at the valve) or nuts that leak.

Complete the Installation

⚠ WARNING



Electrical Shock Hazard

Plug into a grounded 3 prong outlet.

Do not remove ground prong.

Do not use an adapter.

Do not use an extension cord.

Failure to follow these instructions can result in death, fire, or electrical shock.

- Plug into a grounded 3-prong outlet.

2. Wait a few minutes. Check that the compressor is operating properly and that all lights are working.
NOTE: If the refrigerator does not operate, check that the circuit breaker is not tripped or that the household fuse has not blown.

3. Flush the water system. See “Water and Ice Dispensers.”
NOTE: Allow 24 hours to produce the first batch of ice. Allow 72 hours to completely fill ice container.

IMPORTANT: If construction will continue after refrigerator has been installed, unplug refrigerator or disconnect power.

Install Air Filter (on some models)

On some models, your refrigerator's accessory packet includes an air filter, which must be installed prior to use. On some models, the air filter is already installed at the factory. To order a replacement air filter, use part number **W10311524**.

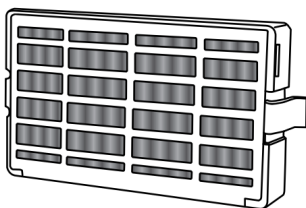

The air filter reduces the buildup of odors. This helps to maintain a cleaner environment inside the refrigerator.

Installing the Air Filter

The filter should be installed behind the vented door, which is located (depending on your model) along either the rear or left interior wall near the top of the refrigerator compartment.

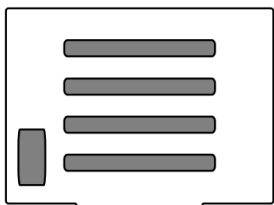

1. Remove the air filter from its packaging.
2. Lift open the vented door.
3. Snap the filter into place.

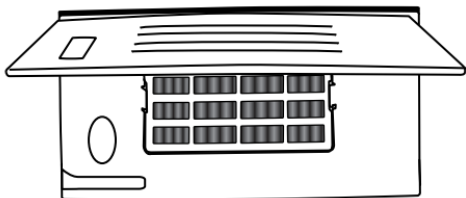

4. Close the vented door.

Installing the Filter Status Indicator (on some models)

The filter comes with a status indicator, which should be activated and installed at the same time the air filter is installed.

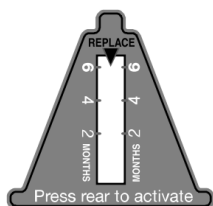

1. Place the indicator facedown on a firm, flat surface.
2. Apply pressure to the bubble on the back of the indicator, until the bubble pops to activate the indicator.
3. Lift open the vented air filter door. On some models, there are notches behind the door.
4. **On models with notches:**
 - Slide the indicator down into the notches, facing outward.
NOTE: The indicator will not easily slide into the notches if the rear bubble has not been popped.
 - Close the air filter door, and check that the indicator is visible through the rectangular hole in the door.
- On models without notches:**
 - Place the indicator in a visible place you will easily remember—either inside the refrigerator or elsewhere in your kitchen or home.

Replacing the Air Filter

The disposable air filter should be replaced every 6 months, when the status indicator has completely changed from white to red.

To order a replacement air filter, see ordering information in the Quick Start Guide.

1. Remove the old air filter by squeezing in on the side tabs.
2. Remove the old status indicator.
3. Install the new air filter and status indicator using the instructions in the previous sections.

Install Produce Preserver (on some models)

Your refrigerator's accessory packet includes a Produce Preserver, which should be installed prior to use. On some models, the Produce Preserver is already installed at the factory. To order a replacement produce preserver, use part number **W10346771**.

The Produce Preserver absorbs ethylene, allowing the ripening process of many produce items to slow down. As a result, certain produce items will stay fresh longer.

Ethylene production and sensitivity varies depending on the type of fruit or vegetable. To preserve freshness, it is best to separate produce with sensitivity to ethylene from fruits that produce moderate to high amounts of ethylene.

	Sensitivity to Ethylene	Ethylene Production
Apples	High	Very High
Asparagus	Medium	Very Low
Berries	Low	Low
Broccoli	High	Very Low
Cantaloupe	Medium	High
Carrots	Low	Very Low
Citrus Fruit	Medium	Very Low
Grapes	Low	Very Low
Lettuce	High	Very Low
Pears	High	Very High
Spinach	High	Very Low

Installing the Produce Preserver

CAUTION: IRRITANT. MAY IRRITATE EYES AND SKIN. DANGEROUS FUMES FORM WHEN MIXED WITH OTHER PRODUCTS.

MAY IRRITATE EYES AND SKIN. DANGEROUS FUMES FORM WHEN MIXED WITH OTHER PRODUCTS.

Do not mix with cleaning products containing ammonia, bleach, or acids. Do not get in eyes, on skin or clothing. Do not breathe dust. Keep out of reach of children.

FIRST AID TREATMENT: Contains potassium permanganate. If swallowed, call a Poison Control Center or doctor immediately. Do not induce vomiting. If in eyes, rinse with water for 15 minutes. If on skin, rinse with water.

The Produce Preserver pouches should be installed in their housing, which is located along an interior side wall of the crisper or convertible drawer.

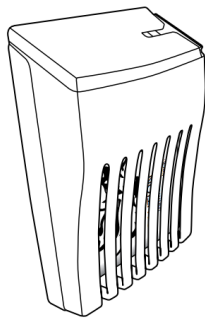

NOTE: For best performance, always use two pouches.

1. Remove the Produce Preserver pouches from their packaging.
2. Lift up on the housing in order to remove it from its mounting tab along the wall.
3. Open the housing by pulling up and out on the back of the top of the housing.
4. Place both pouches inside the housing; then snap the housing back together.
5. Place the housing back on the mounting tab along the wall.

Installing the Status Indicator

The Produce Preserver comes with a status indicator, which should be activated and installed at the same time the pouch is installed.

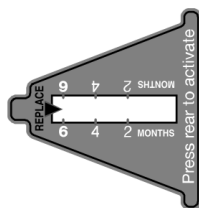

1. Place the indicator facedown on a firm, flat surface.
2. Apply pressure to the bubble on the back of the indicator, until the bubble pops to activate the indicator.
3. Slide open the cap on the Produce Preserver housing.
4. Place the indicator in the top of the housing, facing outward.
5. Slide the cap closed, and check that the indicator is visible through the rectangular hole in the cap.

NOTE: The cap will not close easily if the indicator's rear bubble has not been popped.

Replacing the Produce Preserver Pouches

The disposable pouches should be replaced every 6 months, when the status indicator has completely changed from white to red.

To order replacements, see the contact information in the Quick Start Guide. Order part number **W10346771A** or FRESH1.

1. Remove the used pouches from the produce preserver housing.



2. Remove the old status indicator.
3. Install the new pouches and status indicator using the instructions in the previous sections.

REFRIGERATOR FEATURES

Convertible Drawer Temperature Control (on some models)

The control can be adjusted to properly chill meats or vegetables. The air inside the pan is cooled to avoid "spot" freezing and can be set to keep meats at the National Livestock and Meat Board recommended storage temperatures of 28°F to 32°F (-2°C to 0°C).

To store meat:

Set the control to one of the three Meat settings to store meat at its optimal storage temperature.

To store vegetables:

Set the control to Veg to store vegetables at their optimal storage temperatures.

NOTE: If food starts to freeze, move the control to the right (less cold), toward the Veg setting. Remember to wait 24 hours between adjustments.

Crisper Humidity Control (on some models)

You can control the amount of humidity in the moisture-sealed crisper. Adjust the control to any setting between Low and High.

LOW (open) for best storage of fruits and vegetables with skins.

HIGH (closed) for best storage of fresh, leafy vegetables.

Dual Evaporator (on some models)

Some models come equipped with a dual sequential evaporation system which includes two separate evaporators for the refrigerator and freezer compartments.

Dual evaporation results in higher humidity, which helps keep foods in the refrigerator from spoiling as quickly and improves food quality and freshness in the freezer due to decreased freezer burn. In addition, the dual evaporation system helps keep food smells in the refrigerator from transferring to ice in the freezer.

NOTE: The dual evaporation system is always activated when your refrigerator is operating. You do not need to press any buttons to turn it on.

Water and Ice Dispensers

On how to use your water and ice dispensers, see the online “Side-by-Side Refrigerator Dispensers” Feature Guide.

NOTES:

- Connect to potable water supply only.
- The dispensing system will not operate when either door (refrigerator or freezer) is open.
- Allow 24 hours for the refrigerator to cool down and chill water.
- Allow 24 hours to produce the first batch of ice. Discard the first three batches of ice produced. Wait 72 hours for full ice production.
- On some models, the display screen on the dispenser control panel will turn off automatically and enter “sleep” mode when the control buttons and dispenser pads have not been used for 2 minutes or more. While in “sleep” mode, the first press of a control button will only reactivate the display screen, without changing any settings.

Flush the Water System

Air in the water dispensing system can cause the water dispenser to drip. After connecting the refrigerator to a water source or replacing the water filter, flush the water system. Flushing the water dispensing system forces air from the water line and filter and prepares the water filter for use.

NOTE: As air is cleared from the system, water may spurt out of the dispenser.

1. Using a sturdy container, depress and hold the water dispenser pad for 5 seconds; then release it for 5 seconds.
2. Repeat step 1 until water begins to flow.
3. Once water begins to flow, continue depressing and releasing the dispenser pad (5 seconds on, 5 seconds off) until a total of 3 gallons (12 Liter) has been dispensed.

Additional flushing may be required in some households.

The Water Dispenser

IMPORTANT:

Dispense at least 1 quart (1 Liter) of water every week to maintain a fresh supply.

If the flow of water from the dispenser decreases, it could be caused by low water pressure.

- With the water filter removed, dispense 1 cup (237 mL) of water. If 1 cup of water is dispensed in 8 seconds or less, the water pressure to the refrigerator meets the minimum requirement.
- If it takes longer than 8 seconds to dispense 1 cup of water, the water pressure to the refrigerator is lower than recommended. See “Water Supply Requirements” or online “Troubleshooting” for suggestions.

Ice Maker and Storage Bin

- Allow 24 hours to produce the first batch of ice. Discard the first three batches of ice produced.
- The quality of your ice will be only as good as the quality of the water supplied to your ice maker. Avoid connecting the ice maker to a softened water supply. Water softener chemicals (such as salt) can damage parts of the ice maker and lead to poor quality ice. If a softened water supply cannot be avoided, make sure the water softener is operating properly and is well maintained.
- Do not use anything sharp to break up the ice in the storage bin. This can cause damage to the ice container and the dispenser mechanism.
- Do not store anything on top of or in the ice maker or storage bin.

Style 1

Turning the Ice Maker On/Off:

The On/Off switch, located on the left wall of the freezer door, can only be accessed when the ice storage bin has been removed. See the following section for bin removal instructions.

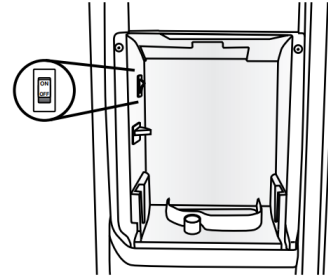

- To turn on the ice maker, flip the switch to the On (up) position.
- To manually turn off the ice maker, flip the switch to the Off (down) position.

NOTE: The ice maker has an automatic shut-off to keep the storage bin from overflowing during normal operation. As ice is made, the ice cubes will fill the ice storage bin, and the ice cubes will raise the shut-off arm to the Off (arm up) position. When the storage bin is at full capacity, the ice maker will automatically stop ice production, but the ice maker On/Off switch will remain in the On (up) position.

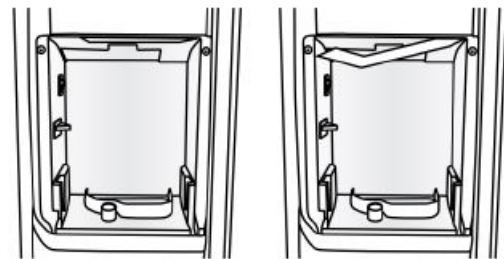

Ice production Off (shut-off arm up)

Ice production On (Shut-off arm down)

Removing and Replacing the Ice Storage Bin:

1. Press down the release lever and tilt the bucket outward. Use both hands to hold the base of the storage bin, and then lift it up and out.

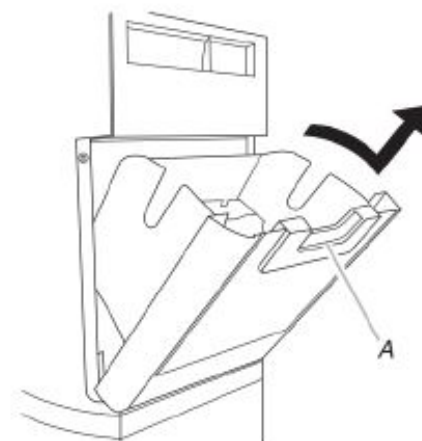

A. Release lever

NOTE: It is not necessary to flip the ice maker On/Off switch to the Off (down) position when removing the storage bin. The storage bin sensor, located on the left wall (right wall on some models) of the freezer door, stops the ice maker from producing ice if the door is open or the storage bin is removed.

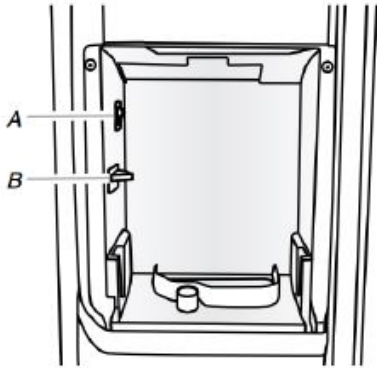

A. On/Off switch B. Storage bin sensor

2. Replace the bin by sliding it onto the door, and then tilting it back into an upright position. The release lever will click when the bin is securely in place.

Style 2

Turning the Ice Maker On/Off:

- To turn on the ice maker, lower the wire shut-off arm to the On position.
- To manually turn off the ice maker, lift the wire Shut-off arm to the Off (arm up) position and listen for the click. Ice can still be dispensed, but no more can be made.

NOTE: The ice maker has an automatic shut-off to keep the storage bin from overfilling during normal operation. As ice is made, the ice cubes will fill the ice storage bin, and the ice cubes will raise the wire shut-off arm to the Off (arm up) position. Do not force the wire shut-off arm up or down.

Removing and Replacing the Ice Storage Bin:

1. Pull the covering panel up from the bottom.
2. Lift the wire shut-off arm so it clicks into the Off (up) position.
3. Lift up the front of the storage bin and pull it out.

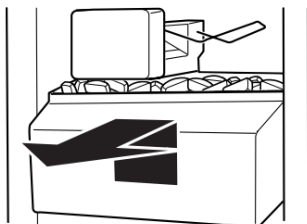

4. Replace the bin by pushing it in all the way or the dispenser will not work.
5. To restart ice production, lower the wire shut-off arm to the On (down) position. Make sure the door is closed tightly.

Style 3

Turning the Ice Maker On/Off:

- To turn on the ice maker, lift open the ice maker door and lower the wire shut-off arm to the On position.
- To manually turn off the ice maker, lift the wire shut-off arm to the Off (arm up) position and listen for the click. Ice can still be dispensed, but no more can be made.

NOTE: The ice maker has an automatic shut-off to keep the storage bin from overfilling during normal operation. As ice is made, the ice cubes will fill the ice storage bin, and the ice cubes will raise the wire shut-off arm to the Off (arm up) position. Do not force the wire shut-off arm up or down.

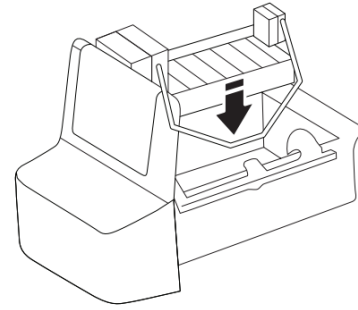

Removing and Replacing the Ice Storage Bin:

1. Lift and hold open the ice maker door.
2. Lift the wire shut-off arm so it clicks into the Off (up) position. Release the ice maker door.
3. Lift up the front of the storage bin and pull it out.
4. Replace the bin by pushing it in all the way or the dispenser will not work.
5. To restart ice production, lift open the ice maker door and push the wire shut-off arm down to the On position.

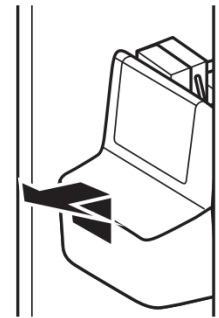

Style 4

Turning the Ice Maker On/Off:

The On/Off switch is located on the bottom of the ice maker, which can be accessed by lifting and opening the ice maker door.

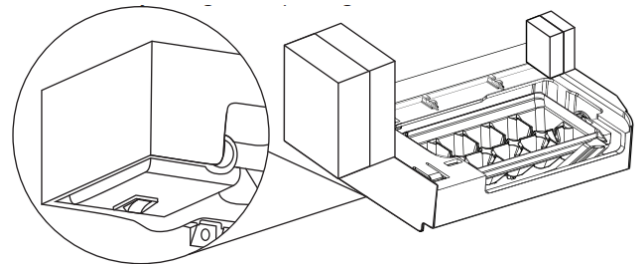

- To turn on the ice maker, lift open the ice maker door, and flip the switch to the On (right) position.
- To manually turn off the ice maker, lift open the ice maker door, and flip the switch to the Off (left) position. Ice can still be dispensed, but no more can be made.

NOTE: Your ice maker has an automatic shut-off to keep the storage bin from overfilling during normal operation. As ice is made, the ice cubes will fill the ice storage bin, and the ice cubes will raise the shut-off arm to the Off (arm up) position. When the storage bin is at full capacity, the ice maker will automatically stop ice production, but the ice maker On/Off switch will remain in the On (up) position.

Removing and Replacing the Ice Storage Bin:

1. Pull the covering panel up from the bottom.
2. Lift the plastic shut-off arm so it clicks into the Off (up) position.
3. Lift up the front of the storage bin and pull it out.
4. Replace the bin by pushing it in all the way or the dispenser will not work.
5. To restart ice production, lower the plastic shut-off arm to the On (down) position. Make sure the door is closed tightly.

Style 5

Turning the Ice Maker On/Off:

The ON/OFF switch is located on the right side of the ice maker, which can be accessed by lifting and opening the ice maker door.

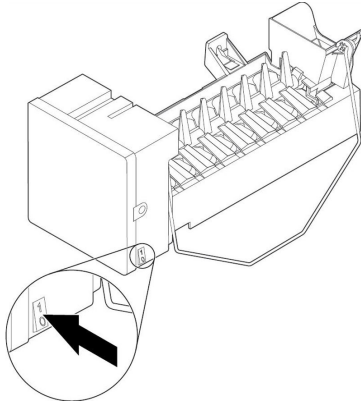

- To turn on the ice maker, lift open the ice maker door, and flip the switch ON/OFF to the ON (I) position.
- To manually turn the ice maker off, lift open the ice maker door, and flip the switch ON/OFF to the OFF (O) position.

NOTE: The ice maker has an automatic shut-off to keep the storage bin from overflowing during normal operation. As ice is made, the ice cubes will fill the ice storage bin and the ice cubes will raise the wire shut-off arm up. When the storage bin is at full capacity, the ice maker will automatically stop ice production, but the ice maker ON/OFF rocker switch will remain in the ON (I) position. Do not force the wire shut-off arm up or down.

Removing and Replacing the Ice Storage Bin:

1. Pull the covering panel up from the bottom.
2. Move the ON/OFF rocker switch to the OFF (O) position.
3. Lift up the front of the storage bin and pull it out.
4. Replace the bin by pushing it in all the way or the dispenser will not work.
5. To restart ice production, move the ON/OFF rocker switch to the ON (I) position. Make sure the door is closed tightly.

Water Filtration System

Do not use with water that is microbiologically unsafe or of unknown quality without adequate disinfection before or after the system. Systems certified for cyst reduction may be used on disinfected waters that may contain filterable cysts.

Water Filter Status Light

The water filter status light will help you know when to change your water filter. This is located on the refrigerator control panel. To order a replacement water filter use part number **W10295370A** (P4RFWB).

Style 1 – Order and Replace status:

- When the dispenser control panel's water filter status display changes to "Order," this tells you that it is almost time to change the water filter cartridge.
- Replace the water filter cartridge when the water filter status display changes to "Replace."

NOTE: If water flow to your water dispenser or ice maker decreases noticeably, change the filter sooner. The filter should be replaced at least every 6 months, depending on your water quality and usage.

Style 2 – Red light status:

- When the light turns red on the control panel, this tells you that it is time to change the water filter cartridge.
- It is recommended that you replace the filter when the status light turns red or water flow to your water dispenser or ice maker decreases noticeably.

NOTE: The filter should be replaced at least every 6 months, depending on your water quality and usage.

Resetting the Filter Status

After changing the water filter, reset the status light.

■ For models with the Options button:

Press the Options button to enter Options mode, press Lock to initiate the reset, and then press Measured Fill to confirm that you want to reset the status light. When the system is reset, the "Order" and "Replace" icons will disappear from the display screen.

■ For models with the Filter button:

Press and hold the Filter button for 3 seconds to reset the status light. When the system is reset, the "Order" and "Replace" icons will disappear from the display screen.

■ For models with the Temp Setting button:

The reset button is located on the control panel in the refrigerator compartment. To reset the status light after changing the filter, press Temp Setting within 3 seconds. The status light will change from red to off when the system is reset.

■ For models with the Light and Ice Type buttons:

Reset the filter status light by pressing and hold Light and Ice Type buttons for 3 seconds. The status light will turn off when the system is reset.

Changing the Water Filter

Style 1 – Top-right corner location:

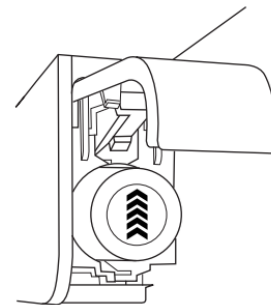

1. Locate the water filter in the top-right corner of the refrigerator compartment.
2. Lift open the filter cover door. The filter will be released and then be ejected as the door is opened.
3. When the door is completely open, pull the filter straight out.

NOTE: There may be some water in the filter. Some spilling may occur. Use a towel to wipe up any spills.

- Take the new filter out of its packaging and remove the cap. Be sure the O-rings are still in place after the cap is removed.

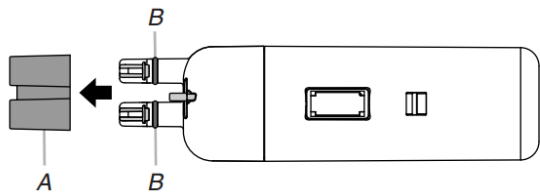

A. Cap B. O-rings

- With the arrow pointing up, align the new filter with the filter housing and slide it into place. The filter cover door will automatically begin to close as the new filter is inserted.
- Close the filter cover door completely in order to snap the filter into place. You may need to press hard.
- After changing the filter, reset the filter status light.
- Flush the water system. See “Water and Ice Dispensers” for details.

Style 2 – Base grille location (automatic ejection):

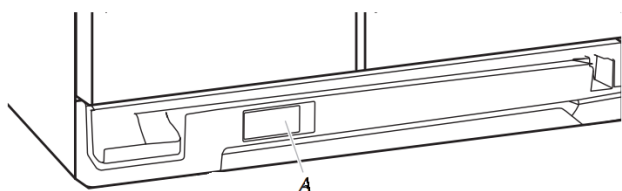

A. Water filter cover door

- Locate the water filter cover door in the base grille, and pull open the filter door. The filter will be released and then be ejected as the door is opened.
 - When the door is completely open, pull the filter straight out.
- NOTE:** There may be some water in the filter. Some spilling may occur. Use a towel to wipe up any spills.

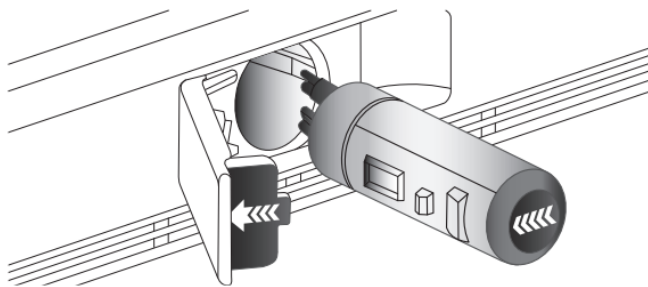

- Take the new filter out of its packaging and remove the covers from the O-rings. Be sure the O-rings are still in place after the covers are removed.
- With the arrow pointing to the left (toward the filter cover door’s hinge), align the new filter with the filter housing and slide into place. The filter cover door will automatically begin to close as the new filter is inserted.
- Close the filter cover door completely in order to snap the filter into place. You may need to press hard.
- Flush the water system. See “Water and Ice Dispensers” for details.

DOOR REMOVAL AND LEVELING STYLE 1

Door Instructions

Gather the required tools and parts and read all instructions before starting installation. Save these instructions for future reference.

⚠WARNING



Electrical Shock Hazard

Disconnect power before removing doors.

Failure to do so could result in death or electrical shock.

NOTE: Before moving your refrigerator into your home, measure the doorway of your home to see whether you need to remove the refrigerator and freezer doors. If door removal is necessary, see the instructions below.

TOOLS NEEDED: Depending on your model, you may need the following: Bubble level, flat-blade screwdriver, Phillips screwdriver tip #2 with 4" long as minimum, 3/16" hex key, 1/4", 3/8", and 5/16" hex-head socket wrench, 1/4" and 5/16" open-ended wrenches or adjustable wrench, internal star drive or 3/8" hex-head socket wrench, TORX[†] T30 screwdriver.

Install and Remove Door Handles

Refrigerator Door Handle Style 1

PARTS INCLUDED: Door handles (2).

To Install the Handles:

- Remove the handles, which are packed inside the refrigerator.

NOTE: To avoid scratching the finish, place the handles on a towel or other soft surface.
- Open the freezer door. On the refrigerator door, place the handle on the shoulder screws.

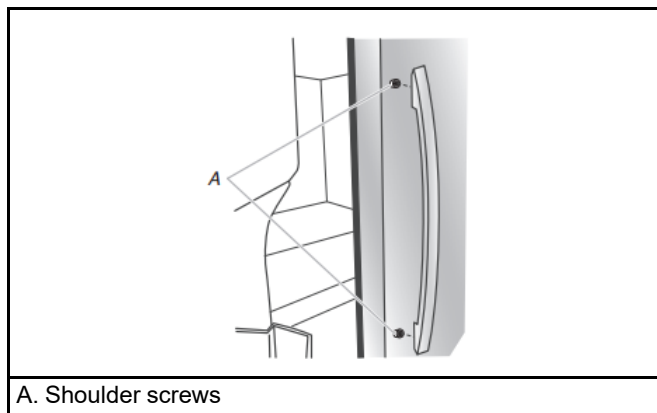

A. Shoulder screws

- Firmly push the handle toward the door until the handle base is flush against the door.
- While holding the handle, push downward until the handle is released from the shoulder screw.

[†]TORX is trademark of Acument Intellectual Properties, LLC.

- Open the refrigerator door and close the freezer door. Repeat steps 2 through 4 to install the other handle onto the freezer door

To Remove the Handles:

- While holding the handle, push upward until the handle is released from the shoulder screw.
- Gently pull the handle away from the door.
- If necessary, use a Phillips screwdriver to remove the shoulder screws from the door.

Refrigerator Door Handle Style 2

PARTS INCLUDED: Door handles(2), 1/8" hex key, spare setscrew(s)

NOTE: The handle mounting setscrews are pre-installed in the handle.

- Remove the handles, which are packed inside the refrigerator.

NOTE: To avoid scratching the finish, place the handles on a towel or other soft surface.

- Open the freezer door. On the refrigerator door, place the handle on the shoulder screws with the setscrews facing the freezer.

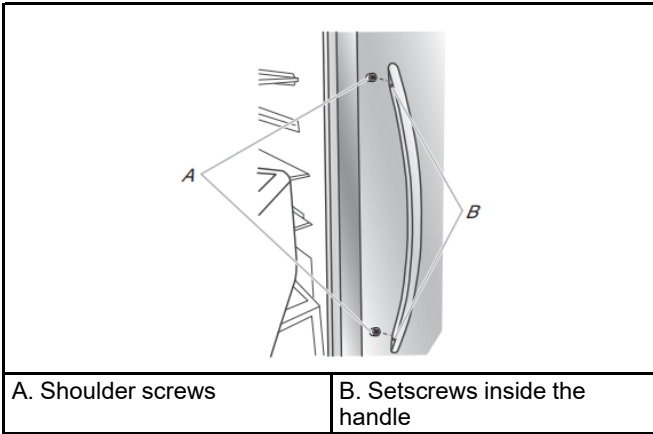

- Firmly push the handle toward the door until the handle base is flush against the door.
- While holding the handle, insert the short end of the hex key into the upper hole and slightly rotate the hex key until it is engaged in the setscrew.

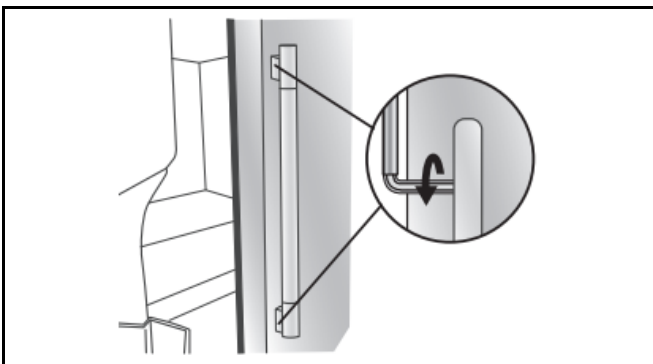

- Using a clockwise motion, tighten the setscrew until it begins to contact the shoulder screw.
- Repeat steps 4 and 5 to begin fastening the lower setscrew.
- Once both setscrews have been partially tightened as outlined in the previous steps, fully tighten both the upper and lower setscrews.

IMPORTANT: When the screws feel tight, tighten them an additional quarter-turn. The handle is not properly installed without this extra tightening.

- Open the refrigerator door and close the freezer door. Repeat steps 2 through 7 to install the other handle onto the freezer door with the setscrews facing the refrigerator.

- Save the hex key and all instructions.

To Remove the Handles:

- While holding the handle, insert the short end of the hex key into the upper hole and slightly rotate the hex key until it is engaged in the setscrew.
- Using a counterclockwise motion, loosen the setscrew a quarter-turn at a time.
- Repeat steps 1 and 2 for the upper setscrew. Gently pull the handle away from the door.
- If necessary, use a Phillips screwdriver to remove the shoulder screws from the door.

Remove Doors and Hinges

If your refrigerator does not fit through the doorway or you are getting rid of your old refrigerator, follow the steps below for door removal.

⚠ WARNING

Electrical Shock Hazard

Disconnect power before removing doors.

Failure to do so could result in death or electrical shock.

- Unplug refrigerator or disconnect power.
- Fully open both doors.
- If your model has water dispensing, please open the water filter door by pulling it toward you as shown below. It is not necessary to remove the water filter itself.

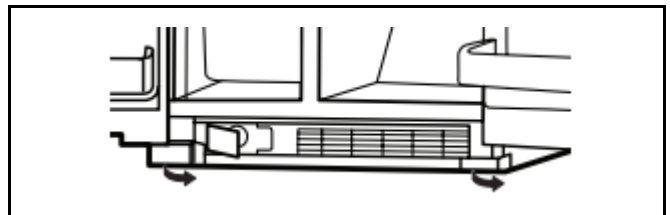

- Pull the base grille toward you from the sides and then from the center until it dislodges.

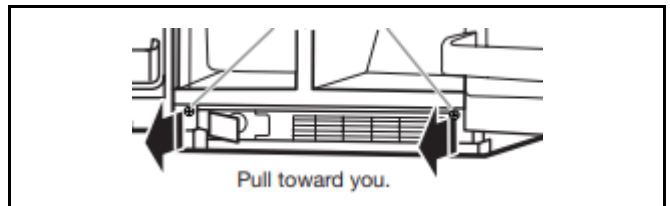

5. To remove the base grille, twist and pull the right side until this side passes underneath the refrigerator door. Then pull the left side of the base grille for complete removal.

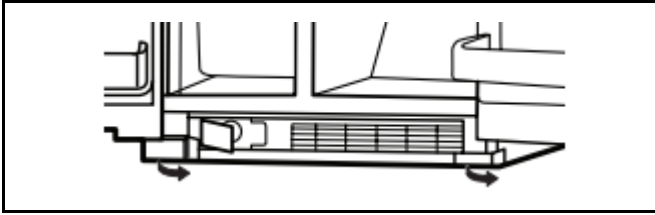

6. If your model has water dispensing in the door, disconnect the water dispenser tubing located below the freezer door.

- Press the blue outer ring against the face of fitting and pull the dispenser tubing free as shown below.

NOTE: Keep the water tubing connector attached to the tube that runs underneath the freezer. The door cannot be removed if the connector is still attached to the tube that runs through the door hinge.

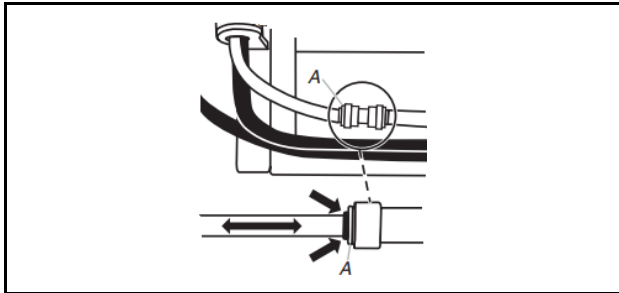

A. Face of fitting

7. If your model has water dispensing in the door, disconnect the wiring located below the freezer door as shown below.

- Remove the wiring clip and the bracket wire using a 1/4" hexagonal-head socket wrench.
- Disconnect the wiring plugs from the bracket wire.

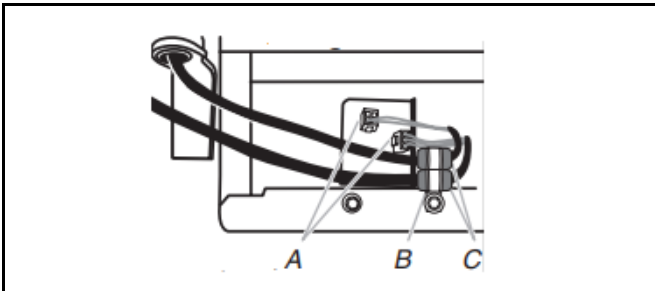

A. Wiring plugs

C. Grommets

B. Wiring clip

8. Close the freezer door and use a TORX T30 screwdriver to remove the top hinge completely as shown below.

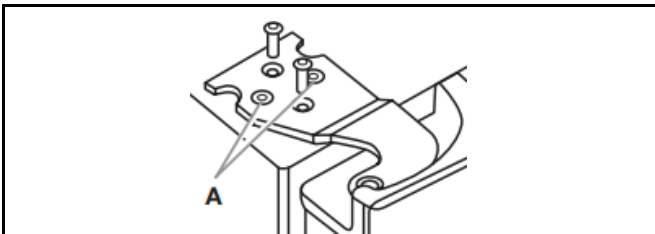

A. Do Not Remove Screws

IMPORTANT: Do not remove either screw A. Hold the door while hinge is being removed.

9. Lift the freezer door straight up off from the bottom hinge as shown below. The water dispenser tubing and wiring will remain attached to the freezer door.

⚠ WARNING

Excessive Weight Hazard

Use two or more people to lift the appliance door.

Failure to do so can result in back or other injury.



NOTE: This may require two people, one to lift the door and the other to feed the water tubing and wiring into the bottom hinge pin.

IMPORTANT: Rest the door on its side on a soft, clean surface, such as a towel, blanket, or piece of cardboard. This will help to avoid scratching or damaging the door, water tubing, and wiring.

10. Close the freezer door and use a TORX T30 screwdriver to remove the top hinge completely as shown below.

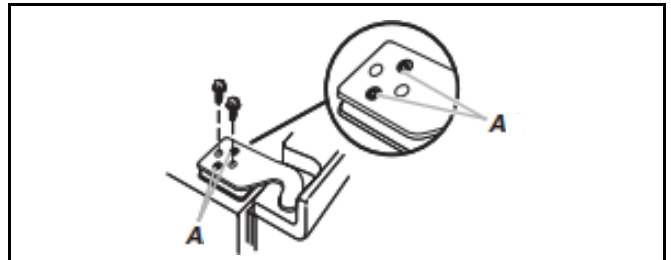

A. Do not remove screws.

IMPORTANT: Do not remove either screw A. Hold the door while hinge is being removed.

11. Lift the refrigerator door straight up off from the bottom hinge as shown below.



IMPORTANT: Rest the door on its side on a soft, clean surface, such as a towel, blanket, or piece of cardboard. This will help to avoid scratching or damaging the door.

- If your refrigerator without doors does not pass through the doorway, you may remove both bottom hinges. Use a 5/16" nut driver to remove these as shown below.

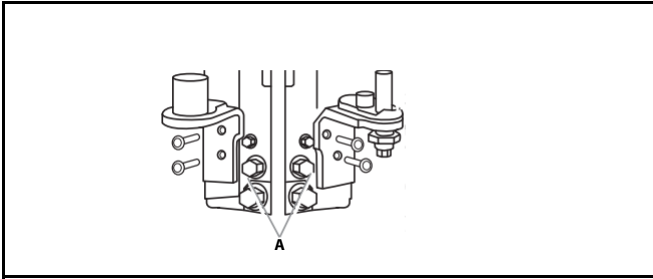

A. Do not remove A screws

IMPORTANT: Do not remove either screw B.

Replace Doors and Hinges

If your doors and bottom hinges have been removed, please follow the next instructions for reinstallation:

- Reinstall both bottom hinges using a 5/16" nut driver to tighten screws as shown below.

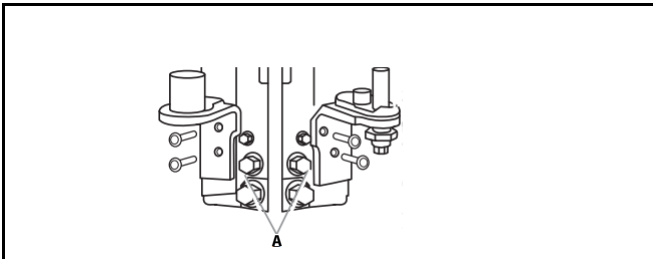

A. Do not remove A screws

- If your model has water dispensing in the door:
 - Lift the freezer door enough to feed the water dispenser tubing and wiring through the bottom hinge pin as shown below.

NOTE: This may require two people, one to lift the door and the other to feed the water tubing and wiring into the bottom hinge pin.



IMPORTANT: Hold the door while hinge is being installed.

- Close the freezer door to align and reinstall the top hinge. Use a TORX T30 screwdriver to tighten the screws as shown below.

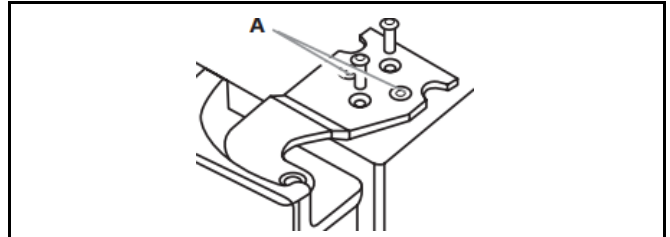

A. Do not remove A screws

IMPORTANT: Provide additional support for the door while top hinge is being reinstalled. Do not depend on the door magnets to secure the door to the cabinet.

- If your model has water dispensing in the door, connect the water dispenser tubing. For the connection, push the tubing into the dispenser tubing until black mark touches the face of fitting as shown below.

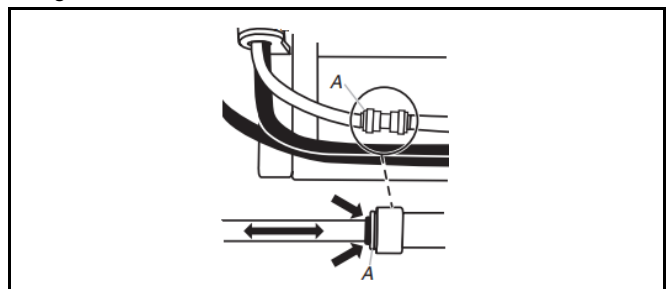

A. Face of fitting

- Connect the wiring as shown below.

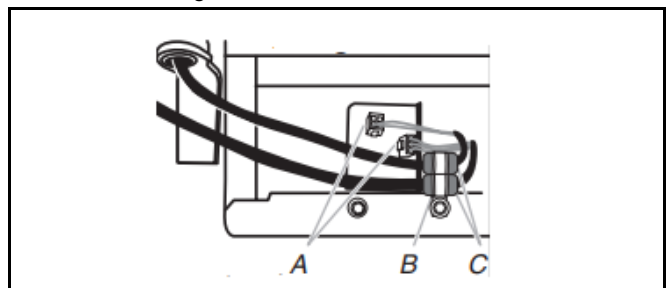

A. Wiring plugs C. Grommets

B. Wiring clip

- Reinstall the wiring clip & the bracket wire using a 1/4" hexagonal head socket wrench.
- Connect the wiring plugs from the bracket wire.
- Lift the refrigerator door enough to insert the door onto the bottom hinge pin as shown below.

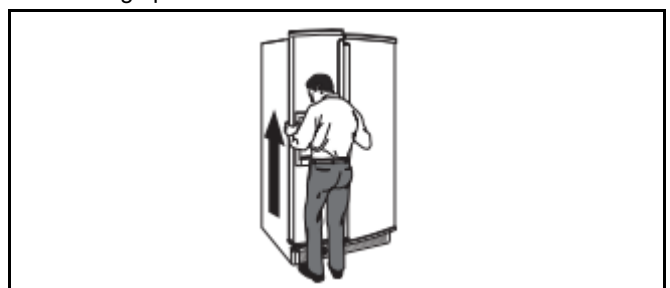

IMPORTANT: Hold the door while hinge is being installed.

- Close the refrigerator door to align and reinstall the top hinge. Use a TORX T30 screwdriver to tighten the screws as shown below.

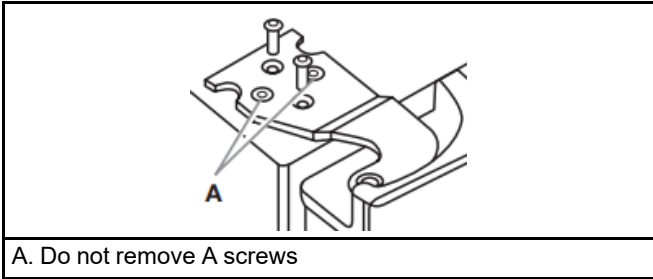

IMPORTANT: Provide additional support for the door while top hinge is being reinstalled. Do not depend on the door magnets to secure the door to the cabinet.

Door Closing and Alignment

Your refrigerator has two front adjustable wheels.

These are used to level the refrigerator under uneven floor conditions or to allow the doors to close more easily. Please follow the instructions below:

- Use a bubble level to check levelness of floor where the rear side of the refrigerator will rest. If the refrigerator is not leveled, adjust or add the shim on flooring to create a leveled floor for the rear side wheels. A leveled rear side prevents the refrigerator cabinet from forming a twist.
- Place the refrigerator into its final location in the kitchen and open both doors.
- Fully open both doors.
- If your model has water dispensing, please open the water filter door by pulling it toward you as shown below. It is not necessary to remove the water filter itself.
- Pull the base grille toward you from the sides and then from the center until it dislodges.

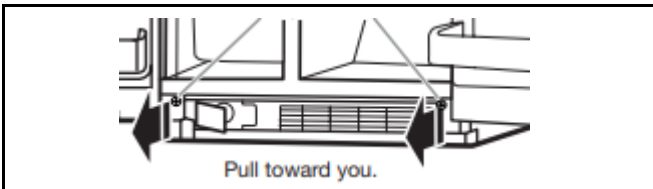

- To remove the base grille, twist and pull the right side until this side passes underneath the refrigerator door. Then pull the left side of the base grille for complete removal.

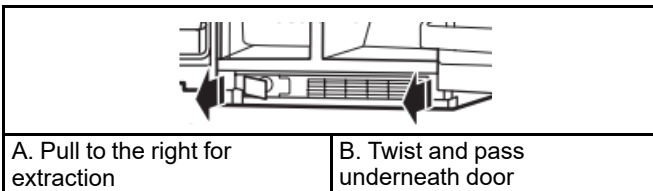

- Raise the wheels while one person pushes on the refrigerator to lift from front side. Use the bubble level on top of the refrigerator or on its side to level the refrigerator. Check bubble level and at the same time observe the gaps and squareness to the adjacent cabinets, furniture, or trim. If adjacent furnishings are not level, it may not be possible to achieve even gaps when refrigerator is level. Continue adjusting until all four corners are steady without rock.

- Use a 3/8" nut driver to turn the leveling screws located in both sides of the refrigerator as shown below. Depending on uneven floor conditions, you must turn one or both screws to the right or left several times to raise or lower the refrigerator.

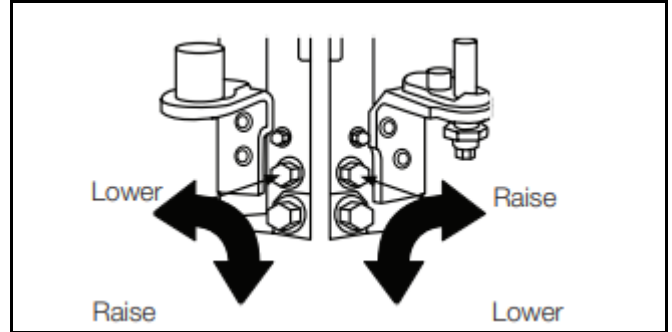

- Close both doors and check that they close as easily as you like. If not, turn both screws to the right to raise the refrigerator by tilting it more to the back until the doors close as easily as you like.
- Check and make sure that the technician sheet is placed in the base grille cavity before assembling the base grille into the cabinet.
- Reinstall the base grille into the cabinet, introducing the left side first and then the right side of the base grille as shown below. You may accommodate the water dispenser tubing and wiring into base grille cavity below the left bottom hinge.
- Attach the base grille by pushing it into the cabinet clips.

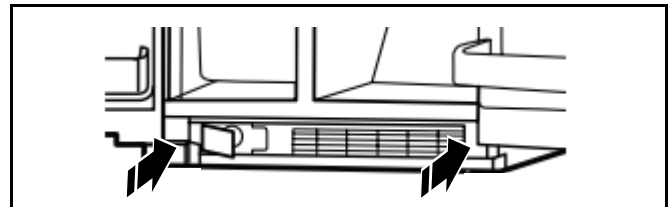

Door Leveling

The refrigerator doors are designed to be slightly misaligned vertically when the refrigerator is empty. If the doors are uneven after food has been placed, please follow the next instructions:

- Use an 11/16" open-ended wrench to loosen the locking nut located below the refrigerator door as shown below. Accommodate the wrench so that it fits in the space.

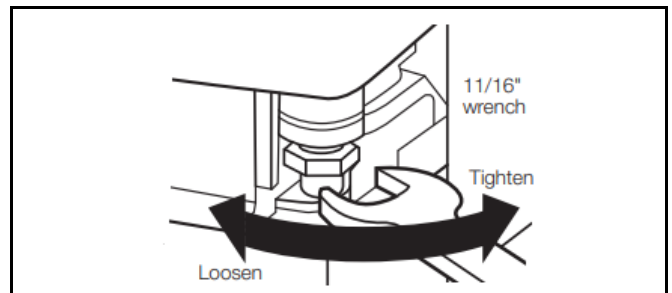

- Use a 5/16" open-ended wrench tool to turn the alignment screw as shown below. Depending on how the refrigerator door is misaligned in relation to the freezer door, you must turn the screw to the right to raise or to the left to lower the refrigerator door until both doors have been aligned vertically.
- Tighten the 11/16" locking nut with the wrench.
- Attach the base grille if it was dislodged.

Door Alignment

1. Locate the hinges on top of your refrigerator. Loosen the hinge screws two full turns.

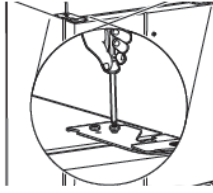

2. Tighten the left and right hinge screws on the refrigerator top.

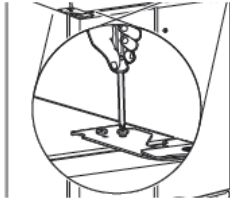

DOOR REMOVAL AND LEVELING STYLE 2

Door Instructions

Gather the required tools and parts and read all instructions before starting installation. Save these instructions for future reference.

⚠ WARNING



Electrical Shock Hazard

Disconnect power before removing doors.

Failure to do so could result in death or electrical shock.

NOTE: Before moving your refrigerator into your home, measure the doorway of your home to see whether you need to remove the refrigerator and freezer doors. If door removal is necessary, see the instructions below.

IMPORTANT: Before you begin, turn the refrigerator control off or turn cooling off. Unplug refrigerator or disconnect power. Remove food, the ice storage bin (on some models), and any adjustable door or utility bins from doors.

TOOLS NEEDED Depending on your model, you may need the following: Bubble level, flat-blade screwdriver, Phillips screwdriver tip #2 with 4" long as minimum, 3/16" hex key, 1/4", 3/8", and 5/16" hex-head socket wrench, 1/4" and 5/16" open-ended wrenches or adjustable wrench, internal star drive or 3/8" hex-head socket wrench, TORX T30 screwdriver.

Install and Remove Door Handles

PARTS INCLUDED: Door handles (2), 1/8" and 3/32" hex key as needed, spare setscrew(s).

To Install the Handles:

NOTE: The handle mounting setscrews are pre-installed in the handle.

1. Remove the handles, which are packed inside the refrigerator.

NOTE: To avoid scratching the finish, place the handles on a towel or other soft surface.

2. Open the freezer door. On the refrigerator door, place the handle on the shoulder screws with the setscrews facing the freezer.

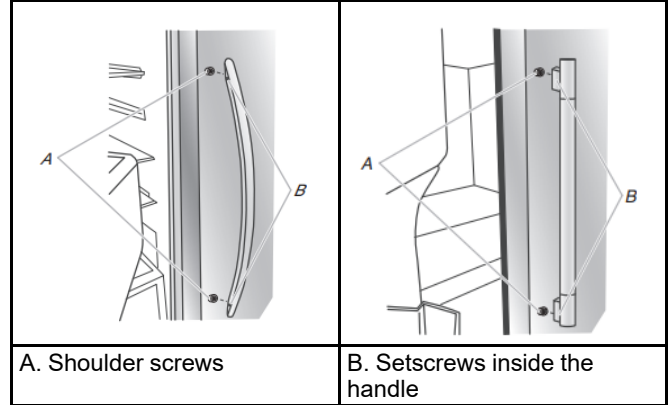

3. Firmly push the handle toward the door until the handle base is flush against the door.

4. While holding the handle, insert the short end of the hex key into the upper hole and slightly rotate the hex key until it is engaged in the setscrew.

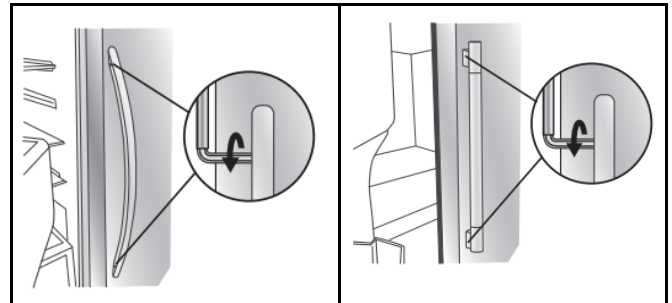

5. Using a clockwise motion, tighten the setscrew until it begins to contact the shoulder screw.
6. Repeat steps 4 and 5 to begin fastening the lower setscrew.
7. Once both setscrews have been partially tightened as outlined in the previous steps, fully tighten both the upper and lower setscrews.

IMPORTANT: When the screws feel tight, tighten them an additional quarter-turn. The handle is not properly installed without this extra tightening.

8. Open the refrigerator door and close the freezer door. Repeat steps 2 through 7 to install the other handle onto the freezer door with the setscrews facing the refrigerator.
9. Save the hex key and all instructions.

To Remove the Handles:

Style 1

1. While holding the handle, insert the short end of the hex key into the upper hole and slightly rotate the hex key until it is engaged in the setscrew.
2. Using a counterclockwise motion, loosen the setscrew a quarter-turn at a time.

- Repeat steps 1 and 2 for the upper setscrew. Gently pull the handle away from the door.
- If necessary, use a Phillips screwdriver to remove the shoulder screws from the door.

Remove Doors and Hinges

⚠ WARNING



Electrical Shock Hazard

Disconnect power before removing doors.

Failure to do so could result in death or electrical shock.

- Unplug refrigerator or disconnect power.
- Open both doors to 90°. Remove the base grille by removing the two screws, then pulling out on the outside corners as shown below.

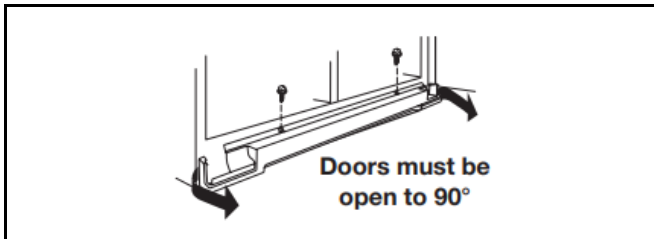

NOTE: The doors must only be opened to 90°. If they are opened all the way, the base grille will not come off.

- Disconnect the water tubing, located behind the base grille on the freezer door side. The dispenser tubing runs through the door hinge and must be disconnected in order to remove the door.

NOTE: On models with the ice storage bin on the door, there are two water tubing connections, as shown. On models with the ice storage bin inside the freezer, there is only one water tubing connection.

- Water Tubing Connection Style 1:** Press the colored outer ring against the face of the fitting and gently pull the dispenser tubing free as shown below.

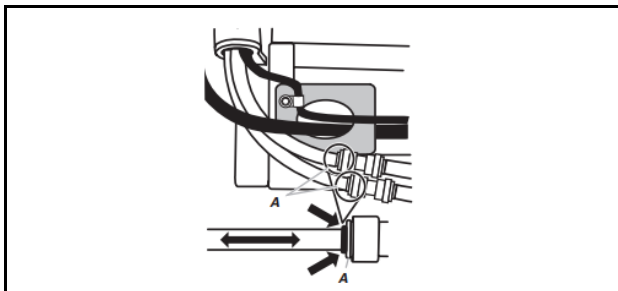

A. Face of Fitting

NOTE: Keep the water tubing connector attached to the tube that runs underneath the freezer. The door cannot be removed if the connector is still attached to the tube that runs through the door hinge.

- Water Tubing Connection Style 2:** Firmly pull on the clasp to release the tube, then pull the water tubing free as show below.

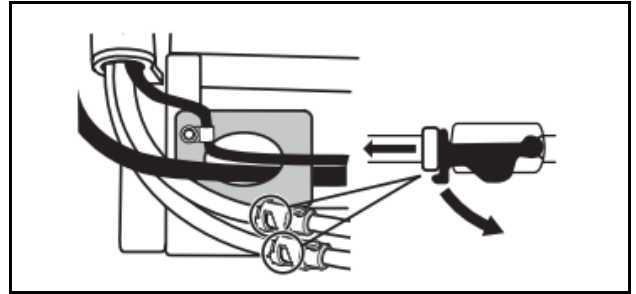

NOTE: Keep the clasp attached to the tube that runs underneath the freezer.

- Disconnect the wiring, located behind the base grille on the freezer door side as shown below.

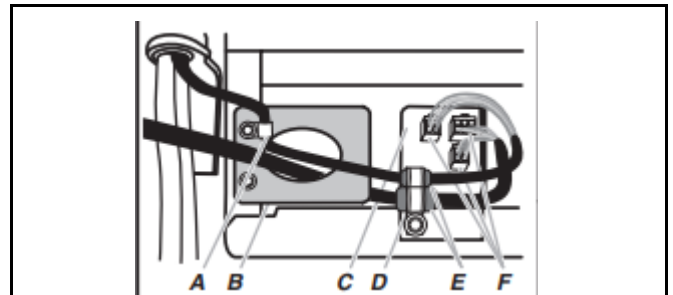

A. P-Clamp

B. Routing Plate

C. Electrical Housing

D. Wiring Clip

E. Grommets

F. Wiring Plugs

On models with the ice storage bin on the door:

NOTE: There are two wiring bundles that run underneath the freezer - a large bundle with a large grommet and two white plugs at the end, and a small bundle with a small grommet and one yellow plug at the end.

- Remove the P-clamp using a 1/4" hex-head socket wrench. Remove the small wiring bundle from the P-clamp.
- Remove the wiring clip using a 1/4" hex-head socket wrench.
- Pull the electrical housing out from under the refrigerator. Disconnect the wiring plugs from the housing.
- Gently pull the large wiring bundle (with two white plugs) through the routing plate.

On models with the ice storage bin inside the freezer:

NOTE: The wiring configuration is simpler than what is shown in the above graphic. There is only one wiring bundle with one wiring plug, and there is not a routing plate.

- Remove the wiring clip using a 1/4" hex-head socket wrench.
 - Pull the electrical housing out from under the refrigerator. Disconnect the wiring plugs from the housing.
- Close both doors and keep them closed until you are ready to lift them free from the cabinet.

- Depending on your model, use a 3/16" hex key or a TORX T30 screwdriver to remove the top-left hinge screws as shown below.

IMPORTANT: Do not remove either screw A. Hold the door while hinge is being removed.

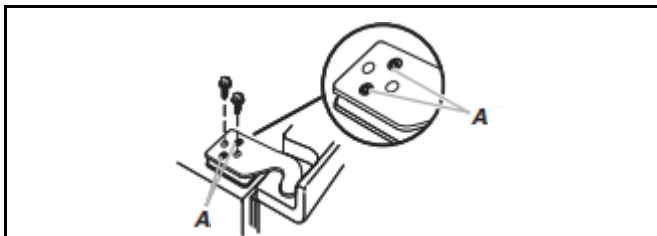

A. Do not remove these screws.

⚠ WARNING

Excessive Weight Hazard

Use two or more people to lift the appliance door.

Failure to do so can result in back or other injury.

- Lift freezer door straight up off bottom hinge as shown below. The water tubing and wiring remain attached to the freezer door and pull through the bottom-left hinge.

NOTE: This may require two people, one to lift the door and another to feed the water tubing and wiring into the bottom hinge pin.



On models with the ice storage bin on the door:

- Be sure the hole in the hinge is clear of obstructions; then gently pull one water tube through the hinge. (Avoid kinking the tube.) Next, gently pull the other water tube through the hinge, again avoiding kinks. Finally, gently pull the wiring bundle (including the grommet and wiring plugs) through the hinge.

On models with the ice storage bin inside the freezer:

- Be sure the hole in the hinge is clear of obstructions; then gently pull the water tube through the hinge. (Avoid kinking the tube.) Next, gently pull the wiring bundle (including the grommet and wiring plug) through the hinge.

IMPORTANT: Rest the door on its side on a soft, clean surface, such as a towel, blanket, or piece of cardboard. This will help to avoid scratching or damaging the door, water tubing, and wiring.

- Use a 3/16" hex key to remove the top-right hinge screws as shown below.

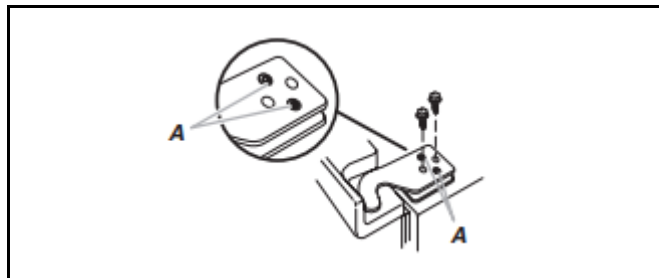

A. Do Not Remove Screws

IMPORTANT: Do not remove either screw A.

- Lift the refrigerator door straight up off bottom hinge.

IMPORTANT: Rest the door on its side on a soft, clean surface, such as a towel, blanket, or piece of cardboard. This will help to avoid scratching or damaging the door.

- It may not be necessary to remove the bottom hinges to move the refrigerator through a doorway. Both bottom hinges have similar construction.

- If necessary, use an internal star drive or a 3/8" hex-head socket wrench to remove the bottom hinges as shown below.

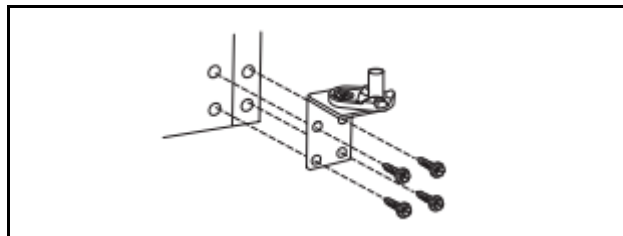

IMPORTANT: The leveler brackets are mounted behind the hinges. If you remove the hinges, make sure that the leveler brackets are replaced when reinstalling the hinges.

Door Closing, Leveling, and Alignment

Your refrigerator has two adjustable front feet—one on the right and one on the left. In most cases, the refrigerator should be steady when both feet are touching the floor. If your refrigerator seems unsteady or if you want the doors to close more easily, adjust the refrigerator's tilt using the instructions below:

1. Use a bubble level to check levelness of floor where the rear side of the refrigerator will rest. If the refrigerator is not leveled, adjust or add the shim on flooring to create a leveled floor for the rear side wheels. A leveled rear side prevents the refrigerator cabinet from forming a twist.
2. Move the refrigerator into its final location. If necessary, open both doors to 90° and remove the base grille as shown below.

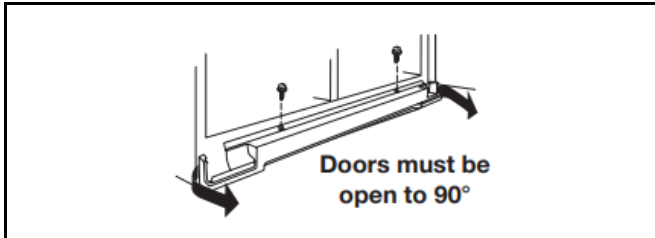

3. The two leveling feet are located on the brackets on each side of the product as shown below.

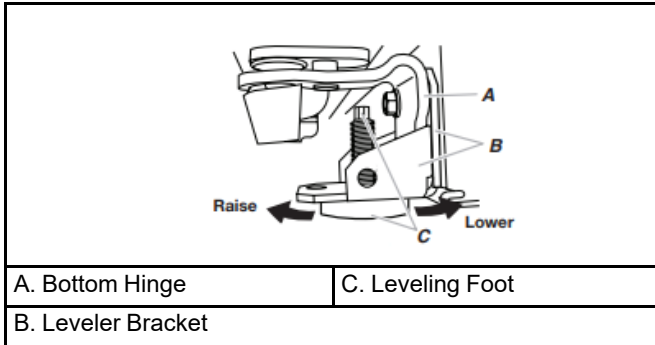

NOTE: Having someone push against the top of the refrigerator takes some weight off the leveling screws. This makes it easier to make adjustments.

4. Use a 1/4" open-ended or adjustable wrench to adjust the leveling feet. Turn the leveling foot to the left to raise that side of the product, or turn it to the right to lower that side of the product. Raise the wheels while one person pushes on the refrigerator to lift from front side. Use the bubble level on top of the refrigerator or on its side to level the refrigerator. Check bubble level and at the same time observe the gaps and squareness to the adjacent cabinets, furniture or trim. If adjacent furnishings are not level, it may not be possible to achieve even gaps when refrigerator is level.

NOTE: Both leveling feet should be snug against the floor, and the rollers should not touch the floor. This keeps the refrigerator from rolling forward when opening the doors. Continue adjusting until all four corners are steady without rock.

5. Open both doors again and check that they close as easily as you like. If not, tilt the refrigerator slightly more to the rear by turning the leveling feet to the left. It may take several more turns, and you should turn both leveling feet the same amount.

NOTE: Whenever you need to move the refrigerator, turn the leveling feet to the right until they are no longer touching the ground. This will allow the refrigerator to roll more easily.

Door Alignment

A refrigerator that is not level from side to side may appear to have doors that are not properly aligned. If the doors appear this way, use the instructions in the previous section to check the leveling.

The doors are designed to be slightly different heights when the refrigerator is empty, in order to account for the weight of food that will be placed on the doors. If the doors are still not aligned after checking the leveling and loading the refrigerator with food, follow the steps below to adjust the door alignment.

1. If necessary, open both doors to 90° and remove the base grille.

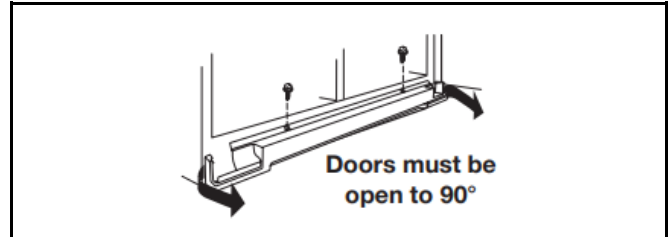

2. Locate the alignment screw on the bottom hinge of the refrigerator door.

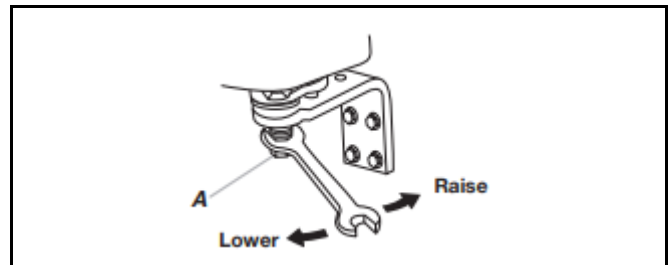

A. Alignment screw

3. Use a 5/16" open-ended or adjustable wrench to turn the screw. To raise the refrigerator door, turn the screw to the right. To lower the door, turn the screw to the left.
4. Check that the doors are even at the top. If necessary, continue to turn the alignment screw until the doors are aligned.
5. Open both doors to 90°. Replace the base grille.

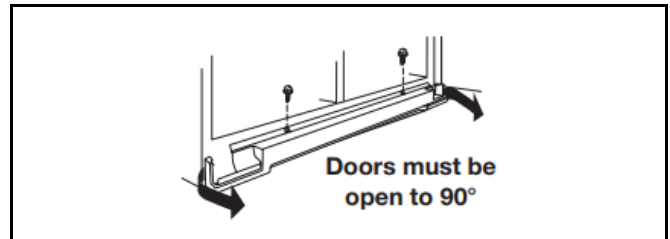

PERFORMANCE DATA SHEET

Water Filtration System

Model P8WB2L (EDR1RXD1B) Capacity 200 Gallons (757 Liters) with PID,

Model W11602565 Capacity 100 Gallons (379 Liters) without PID

Replacement Filter EDR1RXD1, EDR1RXD1B, WHR1RXD1, KAD1RXD1 and EDR1RXD1R



System tested and certified by NSF International against NSF/ANSI Standard 42, 53, 401, and CSA B483.1 for the reduction of contaminants specified on the Performance Data Sheet.

This system has been tested according to NSF/ANSI Standards 42, 53, 401, and CSA 483.1** for the reduction of the substances listed below. The concentration of the indicated substances in water entering the system was reduced to a concentration less than or equal to the permissible limit for water leaving the system, as specified in NSF/ANSI Standards 42, 53, 401, and CSA 483.1**

**Certified to CSA B483.1 only for use in Refrigerator applications.

Substance Reduction	Influent Challenge Concentration	Maximum Permissible Product Water Concentration	Average % Reduction
Aesthetic Effects			
Chlorine Taste/Odor Particulate Class I*	2.0 mg/L ± 10% At least 10,000 particles/mL	50% reduction 85% reduction	97.3
Contaminant Reduction			
Lead: @ pH 6.5 / @ pH 8.5	0.15 mg/L ± 10%	0.005 mg/L	> 99.7
Benzene	0.015 mg/L ± 10%	0.005 mg/L	> 96.6
P-Dichlorobenzene	0.225 mg/L ± 10%	0.075 mg/L	> 99.8
Carbofuran	0.08 mg/L ± 10%	0.040 mg/L	> 98.9
Toxaphene	0.015 ± 10%	0.003 mg/L	> 93.1
Atrazine	0.009 mg/L ± 10%	0.003 mg/L	> 95.2
Asbestos	10 ⁷ to 10 ⁸ fibers/L††	99%	> 99.0
Live Cysts†	50,000/L min.	99.95%	> 99.99
Turbidity	11 NTU ± 10%	0.5 NTU	98.6
Lindane	0.002 ± 10%	0.0002 mg/L	> 99.0
Tetrachloroethylene	0.015 mg/L ± 10%	0.005 mg/L	> 96.5
o-Dichlorobenzene	1.8 mg/L ± 10%	0.60 mg/L	> 99.9
Ethylbenzene	2.1 mg/L ± 10%	0.70 mg/L	99.3
1,2,4-Trichlorobenzene	0.210 mg/L ± 10%	0.07 mg/L	> 99.8
2,4 - D	0.210 mg/L ± 10%	0.07 mg/L	99.9
Styrene	2.0 mg/L ± 10%	0.1 mg/L	99.9
Toluene	3.0 mg/L ± 10%	1.0 mg/L	96.7
Endrin	0.006 mg/L ± 10%	0.002 mg/L	> 96.8
Atenolol	200 ± 20%	60 ng/L	> 95.0
Trimethoprim	140 ± 20%	20 ng/L	> 96.5
Linuron	140 ± 20%	20 ng/L	> 96.4
Estrone	140 ± 20%	20 ng/L	> 96.1
Nonylphenol	1400 ± 20%	200 ng/L	> 96.1

Contaminant Reduction	Influent Challenge Concentration	Maximum Permissible Product Water Concentration	Average % Reduction
Carbamazepine	1400 ± 20%	200 ng/L	> 98.6
Phenytoin	200 ± 20%	30 ng/L	> 95.1
Naproxen	140 ± 20%	20 ng/L	> 96.5
Bisphenol A	2000 ± 20%	300 ng/L	> 99.0
Meprobamate	400 ng/L ± 20%	60 ng/L	> 94.9
DEET	1400 ng/L ± 20%	200 ng/L	> 98.6
Metolachlor	1400 ng/L ± 20%	200 ng/L	> 98.6
Ibuprofen	400 ng/L ± 20%	60 ng/L	> 95.0

Test Parameters: pH = 7.5 ± 0.5 unless otherwise noted. Flow = 0.5 gpm (1.89 lpm). Pressure = 60 psig (413.7 kPa). Temperature = 68°F to 71.6°F (20°C to 22°C). Rated service capacity = 200 gallons (757 liters).

The compounds certified under NSF 401 have been deemed as “emerging compounds/incidental contaminants.” Emerging compounds/incidental contaminants are those compounds that have been detected in drinking water supplies at trace levels. While occurring at only trace levels, these compounds can affect the public acceptance/perception of drinking water quality.

- For installation, operation, and maintenance instructions please refer to the Owner’s Manual.
- It is important that operational, maintenance, and filter replacement requirements be carried out for the product to perform as advertised. Property damage can occur if all instructions are not followed.
- The disposable cartridge must be changed at least every 6 months.
- Use replacement filter part #EDR1RXD1/EDR1RXD1B.2024 suggested retail price of \$59.99 U.S.A./\$69.99 Canada. Prices are subject to change without notice.
- The filter monitor system measures the amount of water that passes through the filter and alerts you when it is time to replace the filter.
- Refer to the “Using the Controls” or “Water Filtration System” section (in the User Instructions or User Guide) to learn how to check the water filter status.
- After changing the water filter, flush the water system. See “Water and Ice Dispensers” or “Water Dispenser” in the User Instructions or User Guide.
- These contaminants are not necessarily in your water supply. While testing was performed under standard laboratory conditions, actual performance may vary.
- For installation, operation and maintenance instructions please refer Owner’s Manual.
- The product is for cold water use only.
- The water system must be installed in compliance with state and local laws and regulations.
- Do not use with water that is microbiologically unsafe or of unknown quality without adequate disinfection before or after the system. Systems certified for cyst reduction may be used on disinfected waters that may contain filterable cysts. EPA Est. No. 082047-TWN-001
- Refer to the “Warranty” section (in the User Instructions or User Guide) for the Manufacturer’s limited warranty, name and telephone number.

Application Guidelines/Water Supply Parameters

Water Supply	Potable City or Well
Water Pressure	30 psi-120 psi (207 kPa-827 kPa)
Water Temperature	33°F-100°F (0.6°C-37.8°C)
Service Flow Rate	0.50 GPM (2.27 L/min.) @ 60 psi (413.7 kPa)

- Your water filtration system will withstand up to 120 psi water pressure. If your water supply is higher than 80 psi, install a pressure reducing valve before installing the water filtration system.

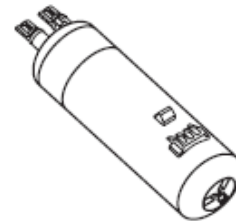

Consumer Support **1.800.442.9991**
By Whirlpool Corporation
2000 North M63
Benton Harbor, MI 49022
Made in Taiwan.

*Class I particle size: > 0.5 um to 1 um
†Based on the use of Cryptosporidium parvum oocysts
††Fibers greater than 10 um in length
©NSF is a registered trademark of NSF International.