

INSTALLATION INSTRUCTIONS AND OWNER'S MANUAL

Side by Side Refrigerator

Do Not Throw Away — Additional important safety information included.

Para las instrucciones en español, visite nuestro sitio de internet.

INSTRUCTIONS D'INSTALLATION ET MANUEL D'UTILISATION

Réfrigérateur côte à côte

Ne pas jeter — Autres consignes de sécurité importantes ci-jointes.

Table of Contents / Table des matières

REFRIGERATOR SAFETY	1	SÉCURITÉ DU RÉFRIGÉRATEUR	21
Proper Disposal of Your Old Refrigerator.....	2	Mise au rebut appropriée de votre vieux réfrigérateur.....	22
INSTALLATION INSTRUCTIONS	2	INSTRUCTIONS D'INSTALLATION	22
Unpack the Refrigerator.....	2	Déballage du réfrigérateur	22
Door Removal, Leveling and Alignment	3	Retrait, réglage de l'aplomb et alignement des portes	23
Handle Installation and Removal	6	Installation et démontage des poignées	26
Location Requirements.....	7	Exigences d'emplacement	27
Electrical Requirements	7	Spécifications électriques.....	28
Water Supply Requirements	7	Spécifications de l'alimentation en eau.....	28
Connect Water Supply.....	8	Raccordement de la canalisation d'eau	29
FILTERS AND ACCESSORIES	10	FILTRES ET ACCESSOIRES	31
Install Air Filter	10	Installation du filtre à air	31
Install Produce Preserver	11	Installation du sachet de conservation pour produits frais	32
Changing the Water Filter	12	Changer le filtre à eau	33
REFRIGERATOR CARE	12	ENTRETIEN DU RÉFRIGÉRATEUR	34
Cleaning	12	Nettoyage	34
Lights	13	Lampes	34
Vacation and Moving Care	14	Entretien avant les vacances ou lors d'un déménagement	36
PROBLEM SOLVER	15	RÉSOLUTION DE PROBLÈMES	37
WATER FILTER CERTIFICATIONS	19	FEUILLE DE DONNÉES SUR LA PERFORMANCE	43
PERFORMANCE DATA SHEET	20		

REFRIGERATOR SAFETY

Your safety and the safety of others are very important.

We have provided many important safety messages in this manual and on your appliance. Always read and obey all safety messages.



This is the safety alert symbol.

This symbol alerts you to potential hazards that can kill or hurt you and others.

All safety messages will follow the safety alert symbol and either the word "DANGER" or "WARNING."

These words mean:

⚠ DANGER

You can be killed or seriously injured if you don't immediately follow instructions.

⚠ WARNING

You can be killed or seriously injured if you don't follow instructions.

All safety messages will tell you what the potential hazard is, tell you how to reduce the chance of injury, and tell you what can happen if the instructions are not followed.

IMPORTANT SAFETY INSTRUCTIONS

WARNING: To reduce the risk of fire, electric shock, or injury when using your refrigerator, follow these basic precautions:

- Plug into a grounded 3 prong outlet.
- Do not remove ground prong.
- Do not use an adapter.
- Do not use an extension cord.
- Disconnect power before servicing.
- Replace all parts and panels before operating.
- Remove doors from your old refrigerator.
- Use nonflammable cleaner.
- Keep flammable materials and vapors, such as gasoline, away from refrigerator.
- Use two or more people to move and install refrigerator.
- Disconnect power before installing ice maker (on ice maker kit ready models only).
- Use a sturdy glass when dispensing ice (on some models).
- Do not hit the refrigerator glass doors (on some models).

SAVE THESE INSTRUCTIONS

State of California Proposition 65 Warnings:

WARNING: This product contains one or more chemicals known to the State of California to cause cancer.

WARNING: This product contains one or more chemicals known to the State of California to cause birth defects or other reproductive harm.

Proper Disposal of Your Old Refrigerator

! WARNING

Suffocation Hazard

Remove doors from your old refrigerator.

Failure to do so can result in death or brain damage.

IMPORTANT: Child entrapment and suffocation are not problems of the past. Junked or abandoned refrigerators are still dangerous, even if they will sit for “just a few days.” If you are getting rid of your old refrigerator, please follow these instructions to help prevent accidents.

Before You Throw Away Your Old Refrigerator or Freezer:

- Take off the doors.
- Leave the shelves in place so that children may not easily climb inside.

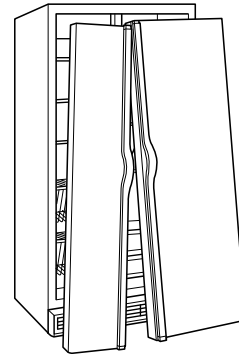

Important information to know about disposal of refrigerants:

Dispose of refrigerator in accordance with Federal and Local regulations. Refrigerants must be evacuated by a licensed, EPA certified refrigerant technician in accordance with established procedures.

INSTALLATION INSTRUCTIONS

Unpack the Refrigerator

! WARNING

Excessive Weight Hazard

Use two or more people to move and install refrigerator.

Failure to do so can result in back or other injury.

Remove packaging materials. Do not use sharp instruments, rubbing alcohol, flammable fluids, or abrasive cleaners to remove tape or glue. These products can damage the surface of your refrigerator. For more information, see “Refrigerator Safety.”

When Moving Your Refrigerator:

Your refrigerator is heavy. When moving the refrigerator for cleaning or service, be sure to cover the floor with cardboard or hardboard to avoid floor damage. Always pull the refrigerator straight out when moving it. Do not wiggle or “walk” the refrigerator when trying to move it, as floor damage could occur.

Important information to know about glass shelves and covers:

Do not clean glass shelves or covers with warm water when they are cold. Shelves and covers may break if exposed to sudden temperature changes or impact, such as bumping. Tempered glass is designed to shatter into many small, pebble-size pieces. This is normal. Glass shelves and covers are heavy. Use both hands when removing them to avoid dropping.

Door Removal, Leveling and Alignment

Gather the required tools and parts and read all instructions before starting installation. Save these instructions for future reference.

IMPORTANT: The graphics on this page are for models with the ice storage bin on the door. On models with the ice storage bin inside the freezer, the wiring and water dispenser tubing configurations are simpler than what is shown in these graphics. Please read all instructions on the next few pages for more information.

NOTE: Before moving your product into your home, measure the doorway of your home to see whether you need to remove the refrigerator and freezer doors. If door removal is necessary, see the instructions below.

IMPORTANT: Before you begin, turn the refrigerator control OFF or turn cooling off. Unplug refrigerator or disconnect power. Remove food, the ice storage bin (on some models), and any adjustable door or utility bins from doors.



⚠ WARNING

Electrical Shock Hazard

Disconnect power before removing doors.
Failure to do so can result in death or electrical shock.

3 Wiring Connection

A. P-clamp
B. Routing Plate
C. Electrical Housing
D. Wiring Clip
E. Grommets
F. Wiring Plugs

4 Top Left Hinge

A. Do Not Remove Screws.

5 Door Removal

6 Top Right Hinge

A. Do Not Remove Screws.

7 Bottom Hinges (Left and Right)

8 Leveling

A. Bottom Hinge
B. Leveler Bracket
C. Leveling Foot

9 Door Alignment (Bottom Right Hinge)

A. Alignment Screw

1 Base Grille

Doors must be open to 90°

2A Water Dispenser Tubing Connection (Style 1)

A. Face of Fitting

2B Water Dispenser Tubing Connection (Style 2)

TOOLS NEEDED:

Bubble level, Phillips screwdriver, 3/16" hex key, 1/4" hex-head socket wrench, 1/4" and 5/16" open-ended wrenches or adjustable wrench, internal star drive or 3/8" hex-head socket wrench

Remove the Doors

⚠ WARNING



Electrical Shock Hazard

Disconnect power before removing doors.

Failure to do so can result in death or electrical shock.

1. Unplug refrigerator or disconnect power.
2. Open both doors to 90°. Remove the base grille by removing the two screws, then pulling out on the outside corners. See *Graphic 1*.
3. Disconnect the water tubing, located behind the base grille on the freezer door side. The dispenser tubing runs through the door hinge, and must be disconnected in order to remove the door.

NOTE: The doors must only be opened to 90°. If they are opened all the way, the base grille will not come off.

NOTE: On models with the ice storage bin on the door, there are two water tubing connections, as shown. On models with the ice storage bin inside the freezer, there is only one water tubing connection.

- **Style 1:** Press the colored outer ring against the face of fitting and pull the water tubing free. See *Graphic 2A*.

NOTE: Keep the water tubing connector attached to the tube that runs underneath the freezer. The door cannot be removed if the connector is still attached to the tube that runs through the door hinge.

- **Style 2:** Firmly pull on the clasp to release the tube, then pull the water tubing free. See *Graphic 2B*.

NOTE: Keep the clasp attached to the tube that runs underneath the freezer.

4. Disconnect the wiring, located behind the base grille on the freezer door side. See *Graphic 3*.

On models with the ice storage bin on the door:

NOTE: There are two wiring bundles that run underneath the freezer - a large bundle with a large grommet and two white plugs at the end, and a small bundle with a small grommet and one yellow plug at the end.

- Remove the P-clamp using a 1/4" hex-head socket wrench. Remove the small wiring bundle from the P-clamp.
- Remove the wiring clip using a 1/4" hex-head socket wrench.
- Pull the electrical housing out from under the refrigerator. Disconnect the wiring plugs from the housing.
- Gently pull the large wiring bundle (with two white plugs) through the routing plate.

On models with the ice storage bin inside the freezer:

NOTE: The wiring configuration is simpler than what is shown in *Graphic 3*. There is only one wiring bundle with one wiring plug, and there is not a routing plate.

- Remove the wiring clip using a 1/4" hex-head socket wrench.
 - Pull the electrical housing out from under the refrigerator. Disconnect the wiring plug from the housing.
5. Close both doors and keep them closed until you are ready to lift them free from the cabinet.
 6. Use a 3/16" hex key to remove the top left hinge screws as shown. See *Graphic 4*.

IMPORTANT: Do not remove either screw A.

⚠ WARNING

Excessive Weight Hazard

Use two or more people to lift the freezer door.

Failure to do so can result in back or other injury.

7. Lift freezer door straight up off bottom hinge. See *Graphic 5*. The water tubing and wiring remain attached to the freezer door and pull through the bottom left hinge.
- NOTE:** This may require two people - one to lift the door and another to feed the water tubing and wiring through the hinge.

On models with the ice storage bin on the door:

- Be sure the hole in the hinge is clear of obstructions, then gently pull one water tube through the hinge. (Avoid kinking the tube.) Next, gently pull the other water tube through the hinge, again avoiding kinks. Finally, gently pull the wiring bundle (including the grommet and wiring plugs) through the hinge.

On models with the ice storage bin inside the freezer:

- Be sure the hole in the hinge is clear of obstructions, then gently pull the water tube through the hinge. (Avoid kinking the tube.) Next, gently pull the wiring bundle (including the grommet and wiring plug) through the hinge.

IMPORTANT: Rest the door on its side on a soft, clean surface, such as a towel, blanket or piece of cardboard. This will help avoid damaging the door, water tubing and wiring.

8. Use a 3/16" hex key to remove the top right hinge screws as shown. See *Graphic 6*.
- IMPORTANT:** Do not remove either screw A.
9. Lift the refrigerator door straight up off bottom hinge.
- IMPORTANT:** Rest the door on its side on a soft, clean surface, such as a towel, blanket or piece of cardboard. This will help avoid damaging the door.
10. It may not be necessary to remove the bottom hinges to move the refrigerator through a doorway. Both bottom hinges have similar construction.
- If necessary, use an internal star drive or a 3/8" hex-head socket wrench to remove the bottom hinges. See *Graphic 7*.

IMPORTANT: The leveler brackets are mounted behind the hinges. If you remove the hinges, make sure that the leveler brackets are replaced when reinstalling the hinges.

Replace the Doors and Hinges

1. Replace both bottom hinges, if removed. Make sure that the leveler brackets are assembled behind the hinges. Tighten screws.

IMPORTANT: When the screws are tightened properly, there should not be any gaps between the refrigerator, leveler bracket and hinge.

WARNING

Excessive Weight Hazard

Use two or more people to lift the freezer door.

Failure to do so can result in back or other injury.

2. Before replacing the freezer door on the bottom left hinge, feed the wiring and water tubing through the hinge.

On models with the ice storage bin on the door:

- Feed the small wiring bundle through the hinge. Assistance may be needed.

IMPORTANT: Do not feed the large wiring bundle through the hinge. This bundle is intended to run directly from the door to the connections beneath the freezer. Forcing the large bundle through the hinge may damage the door and/or the wiring, and will keep the door from closing properly.

- Feed both water tubes through the bottom left hinge, then replace the freezer door on the hinge. Assistance may be needed.

On models with the ice storage bin inside the freezer:

- Feed the wiring bundle through the hinge. Assistance may be needed.
- Feed the water tube through the bottom left hinge, then replace the freezer door on the hinge. Assistance may be needed.

NOTE: Provide additional support for the doors while the top hinges are being replaced. Do not depend on the door magnets to hold the doors in place while you are working.

3. Align and replace the top left hinge as shown. See *Graphic 4*. Tighten screws.
4. Reconnect water tubing and wiring.

IMPORTANT: Do not intertwine the water tubing and wiring bundles when reconnecting them.

On models with the ice storage bin on the door:

- **Water Connection Style 1:** Push the larger $\frac{5}{16}$ " (7.94 mm) water tube into the blue fitting until it stops, then push the smaller $\frac{1}{4}$ " (6.35 mm) water tube into the green fitting until it stops. See *Graphic 2A*.

Water Connection Style 2: Push the black water tube with the blue tip into the blue fitting until it stops. Close the clasp around the tubing, making sure it snaps into place. Repeat this process to connect the red-tipped black water tube and the red fitting. See *Graphic 2B*.

- Reinstall the P-clamp around the small wiring bundle (with one yellow plug), then replace the P-clamp on the top screw hole of the routing plate. See *Graphic 3*.
- Gently route the large wiring bundle (with two white plugs) through the hole in the routing plate, so that the wiring runs behind the right side of the routing plate. See *Graphic 3*.

NOTE: The large wiring bundle should always remain below the small wiring bundle.

- Reconnect the wiring plugs to the electrical housing, then push the housing back under the refrigerator. Align the left hole in the front lip of the housing with the right hole in the refrigerator's base crossbar. See *Graphic 3*.
- Reinstall the wiring clip over the grommets. First install the smaller grommet into the top of the clip, then install the larger grommet into the bottom of the clip (closest to the screw hole). See *Graphic 3*.
- Align the clip's screw hole with the left hole in the electrical housing and the right hole in the crossbar, and screw in the clip using a single screw. Tighten screw. See *Graphic 3*.

IMPORTANT: Once connected, the wiring bundles should not be taut. Some flexibility is needed to allow the freezer door to open properly.

On models with the ice storage bin inside the freezer:

- **Water Connection Style 1:** Push the water tube into the fitting until it stops. See *Graphic 2A*.
 - **Water Connection Style 2:** Push the water tube into the fitting until it stops. Close the clasp around the tubing, making sure it snaps into place. See *Graphic 2B*.
 - Reconnect the wiring plug to the electrical housing, then push the housing back under the refrigerator. Align the left hole in the front lip of the housing with the right hole in the refrigerator's base crossbar. See *Graphic 3*.
 - Reinstall the wiring clip over the grommet. See *Graphic 3*.
 - Align the clip's screw hole with the left hole in the electrical housing and the right hole in the crossbar, and screw in the clip using a single screw. Tighten screw. See *Graphic 3*.
- IMPORTANT:** Once connected, the wiring should not be taut. Some flexibility is needed to allow the freezer door to open properly.

5. Replace the refrigerator door by lifting the door onto the bottom right hinge.
6. Align and replace the top right hinge as shown. See *Graphic 6*. Tighten screws.
7. Replace the ice storage bin (on some models) and any adjustable door or utility bins.

WARNING



Electrical Shock Hazard

Plug into a grounded 3 prong outlet.

Do not remove ground prong.

Do not use an adapter.

Do not use an extension cord.

Failure to follow these instructions can result in death, fire, or electrical shock.

8. Plug refrigerator into a grounded 3 prong outlet.

Leveling and Door Closing

Your refrigerator has two adjustable front feet — one on the right and one on the left. In most cases, the refrigerator should be steady when both feet are touching the floor. If your refrigerator seems unsteady or if you want the doors to close more easily, adjust the refrigerator's tilt using the instructions below:

1. Move the refrigerator into its final location. If necessary, open both doors to 90° and remove the base grille. See *Graphic 1*.
2. The two leveling feet are located on the brackets on each side of the product. See *Graphic 8*.

NOTE: Having someone push against the top of the refrigerator takes some weight off the leveling feet. This makes it easier to make adjustments.

3. Use a ¼" open-ended or adjustable wrench to adjust the leveling feet. Turn the leveling foot to the left to raise that side of the product, or turn it to the right to lower that side of the product.

NOTE: Both leveling feet should be snug against the floor, and the rollers should not touch the floor. This keeps the refrigerator from rolling forward when opening the doors.

4. Open both doors again and check that they close as easily as you like. If not, tilt the refrigerator slightly more to the rear by turning the leveling feet to the left. It may take several more turns, and you should turn both leveling feet the same amount.

5. Use a bubble level to check the leveling of the refrigerator.

NOTE: Whenever you need to move the refrigerator, turn the leveling feet to the right until they are no longer touching the ground. This will allow the refrigerator to roll more easily.

Door Alignment

A refrigerator that is not level from side-to-side may appear to have doors that are not properly aligned. If the doors appear this way, use the instructions in the previous section to check the leveling.

The doors are designed to be slightly different heights when the refrigerator is empty, in order to account for the weight of food that will be placed on the doors. If the doors are still not aligned after checking the leveling and loading the refrigerator with food, follow the steps below to adjust the door alignment.

1. If necessary, open both doors to 90° and remove the base grille. See *Graphic 1*.
2. Locate the alignment screw on the bottom hinge of the refrigerator door. See *Graphic 9*.
3. Use a ⅝" open-ended or adjustable wrench to turn the screw. To raise the refrigerator door, turn the screw to the right. To lower the door, turn the screw to the left.
4. Check that the doors are even at the top. If necessary, continue to turn the alignment screw until the doors are aligned.
5. Open both doors to 90°. Replace the base grille. See *Graphic 1*.

Handle Installation and Removal

PARTS INCLUDED: Door handles (2), ⅛" and ⅜" hex key as needed, spare setscrew(s).

To Install the Handles:

NOTE: The handle mounting setscrews are preinstalled in the handle.

1. Remove the handles, which are packed inside the refrigerator.

NOTE: To avoid scratching the finish, place the handles on a towel or other soft surface.

2. Open the freezer door. On the refrigerator door, place the handle on the shoulder screws with the setscrews facing the freezer.

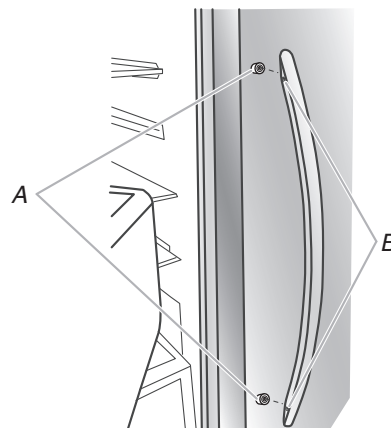

A. Shoulder screws
B. Setscrews inside the handle

3. Firmly push the handle toward the door until the handle base is flush against the door.
4. While holding the handle, insert the short end of the hex key into the upper hole and slightly rotate the hex key until it is engaged in the setscrew.

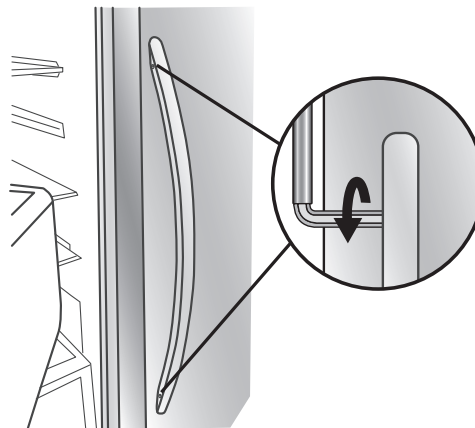

5. Using a clockwise motion, tighten the setscrew until it begins to contact the shoulder screw.
 6. Repeat steps 4 and 5 to begin fastening the lower setscrew.
 7. Once both setscrews have been partially tightened as outlined in the previous steps, fully tighten both the upper and lower setscrews.
- IMPORTANT:** When the screws feel tight, tighten them an additional quarter-turn. The handle is not properly installed without this extra tightening.
8. Open the refrigerator door and close the freezer door. Repeat steps 2 through 7 to install the other handle onto the freezer door with the setscrews facing the refrigerator.
 9. Save the hex key and all instructions.

To Remove the Handles:

1. While holding the handle, insert the short end of the hex key into the lower setscrew hole and slightly rotate the hex key until it is engaged in the setscrew.
2. Using a counterclockwise motion, loosen the setscrew a quarter-turn at a time.
3. Repeat steps 1 and 2 for the upper setscrew. Gently pull the handle away from the door.
4. If necessary, use a Phillips screwdriver to remove the shoulder screws from the door.

Location Requirements

⚠️ WARNING



Explosion Hazard

Keep flammable materials and vapors, such as gasoline, away from refrigerator.

Failure to do so can result in death, explosion, or fire.

IMPORTANT: This refrigerator is designed for indoor household use only.

To ensure proper ventilation for your refrigerator, allow for ½" (1.27 cm) of space on each side and at the top. Allow for 1" (2.54 cm) of space behind the refrigerator. If your refrigerator has an ice maker, allow extra space at the back for the water line connections. When installing your refrigerator next to a fixed wall, leave a 2" (5.08 cm) minimum space on each side (depending on your model) to allow the doors to swing open.

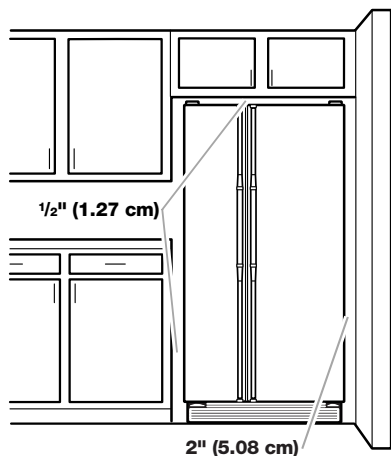

NOTES:

- This refrigerator is intended for use in a location where the temperature ranges from a minimum of 55°F (13°C) to a maximum of 110°F (43°C). The preferred room temperature range for optimum performance, which reduces electricity usage and provides superior cooling, is between 60°F (15°C) and 90°F (32°C). It is recommended that you do not install the refrigerator near a heat source, such as an oven or radiator.
- Normal minimum cabinet cut-out width required for product installation is 36" (91.44 cm). However, if the product is placed against an extended wall and the ability to remove the crisper pans is desired, an additional 18" (45.72 cm) of cabinet width is required, so a total cabinet opening width of 54" (137.16 cm) is recommended.

Electrical Requirements

⚠️ WARNING



Electrical Shock Hazard

Plug into a grounded 3 prong outlet.

Do not remove ground prong.

Do not use an adapter.

Do not use an extension cord.

Failure to follow these instructions can result in death, fire, or electrical shock.

Before you move your refrigerator into its final location, it is important to make sure you have the proper electrical connection.

Recommended Grounding Method

A 115 volt, 60 Hz, AC only, 15- or 20-amp fused, grounded electrical supply is required. It is recommended that a separate circuit serving only your refrigerator be provided. Use an outlet that cannot be turned off by a switch. Do not use an extension cord.

NOTE: Before performing any type of installation or cleaning, or removing a light bulb, turn cooling off or turn the control (Thermostat, Refrigerator or Freezer Control depending on the model) to OFF, and then disconnect the refrigerator from the electrical source. When you are finished, reconnect the refrigerator to the electrical source and turn cooling on or reset the control (Thermostat, Refrigerator or Freezer Control depending on the model) to the desired setting. See "Using the Controls" in the User Instructions, User Guide, or Use & Care Guide.

Water Supply Requirements

Gather the required tools and parts before starting installation. Read and follow the instructions provided with any tools listed here.

TOOLS NEEDED:

- Flat-blade screwdriver
- ¼" nut driver
- 7/16" and ½" open-end or two adjustable wrenches
- ¼" drill bit
- Cordless drill

NOTE: Your refrigerator dealer has a kit available with a ¼" (6.35 mm) saddle-type shutoff valve, a union, and copper tubing. Before purchasing, make sure a saddle-type valve complies with your local plumbing codes. Do not use a piercing-type or 3/16" (4.76 mm) saddle valve which reduces water flow and clogs more easily.

IMPORTANT:

- All installations must meet local plumbing code requirements.
- Use copper tubing and check for leaks. Install copper tubing only in areas where the household temperatures will remain above freezing.

Water Pressure

A cold water supply with water pressure of between 30 and 120 psi (207 and 827 kPa) is required to operate the water dispenser and ice maker. If you have questions about your water pressure, call a licensed, qualified plumber.

- If your refrigerator has a water dispenser: After installation is complete, use the water dispenser to check the water pressure.
 - With the water filter removed, dispense 1 cup (237 mL) of water. If 1 cup of water is dispensed in 8 seconds or less, the water pressure to the refrigerator meets the minimum requirement.
 - If it takes longer than 8 seconds to dispense 1 cup of water, the water pressure to the refrigerator is lower than recommended. See "Problem Solver" for suggestions.

Reverse Osmosis Water Supply

IMPORTANT: The pressure of the water supply coming out of a reverse osmosis system going to the water inlet valve of the refrigerator needs to be between 30 and 120 psi (207 and 827 kPa).

If a reverse osmosis water filtration system is connected to your cold water supply, the water pressure to the reverse osmosis system needs to be a minimum of 40 to 60 psi (276 to 414 kPa).

If the water pressure to the reverse osmosis system is less than 40 to 60 psi (276 to 414 kPa):

- Check to see whether the sediment filter in the reverse osmosis system is blocked. Replace the filter if necessary.
- Allow the storage tank on the reverse osmosis system to refill after heavy usage.
- If your refrigerator has a water filter, it may further reduce the water pressure when used in conjunction with a reverse osmosis system. Remove the water filter. See "Water Filtration System" in the User Instructions, User Guide, or Use & Care Guide.

If you have questions about your water pressure, call a licensed, qualified plumber.

Connect Water Supply

Read all directions before you begin.

IMPORTANT:

- Plumbing shall be installed in accordance with the International Plumbing Code and any local codes and ordinances.
- The gray water tubing on the back of the refrigerator (which is used to connect to the household water line) is a PEX (cross-linked polyethylene) tube. Copper and PEX tubing connections from the household water line to the refrigerator are acceptable, and will help avoid off-taste or odor in your ice or water. Check for leaks.

If PEX tubing is used instead of copper, we recommend the following Whirlpool Part Numbers:

W10505928RP (7 ft [2.14 m] jacketed PEX),
8212547RP (5 ft [1.52 m] PEX), or
W10267701RP (25 ft [7.62 m] PEX).

- Install tubing only in areas where temperatures will remain above freezing.

TOOLS NEEDED:

Gather the required tools and parts before starting installation.

- Flat-blade screwdriver
- $\frac{7}{16}$ " and $\frac{1}{2}$ " open-end wrenches or two adjustable wrenches
- $\frac{1}{4}$ " nut driver

Connect to Water Line

IMPORTANT: If you turn the refrigerator on before the water line is connected, turn the ice maker OFF.

Style 1 (Recommended)

1. Unplug refrigerator or disconnect power.
2. Turn OFF main water supply. Turn ON nearest faucet long enough to clear line of water.
3. Use a quarter-turn shutoff valve or the equivalent, served by a $\frac{1}{2}$ " copper household supply line.

NOTE: To allow sufficient water flow to the refrigerator, a minimum $\frac{1}{2}$ " size copper household supply line is recommended.

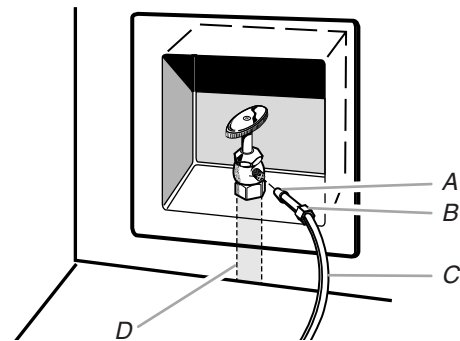

A. Bulb
B. Nut
C. Copper tubing (to refrigerator)
D. Household supply line ($\frac{1}{2}$ " minimum)

4. Now you are ready to connect the copper tubing to the shutoff valve. Use $\frac{1}{4}$ " (6.35 mm) O.D. (outside diameter) soft copper tubing to connect the shutoff valve and the refrigerator.
 - Ensure that you have the proper length needed for the job. Be sure both ends of the copper tubing are cut square.
 - Slip compression sleeve and compression nut onto copper tubing as shown. Insert end of tubing into outlet end squarely as far as it will go. Screw compression nut onto outlet end with adjustable wrench. Do not overtighten.

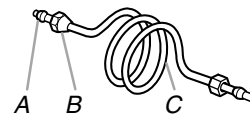

A. Compression sleeve
B. Compression nut
C. Copper tubing

5. Place the free end of the tubing into a container or sink, and turn on main water supply to flush out tubing until water is clear. Turn off shutoff valve on the water pipe.

NOTE: Always drain the water line before making the final connection to the inlet of the water valve, to avoid possible water valve malfunction.
6. Bend the copper tubing to meet the water line inlet, which is located on the back of the refrigerator cabinet as shown. Leave a coil of copper tubing to allow the refrigerator to be pulled out of the cabinet or away from the wall for service.

Style 2

1. Unplug refrigerator or disconnect power.
2. Turn OFF main water supply. Turn ON nearest faucet long enough to clear line of water.
3. Locate a 1/2" (1.27 cm) to 1 1/4" (3.18 cm) vertical cold water pipe near the refrigerator.

IMPORTANT:

- Make sure it is a cold water pipe.
 - Horizontal pipe will work, but drill on the top side of the pipe, not the bottom. This will help keep water away from the drill and normal sediment from collecting in the valve.
4. Determine the length of copper tubing you need. Measure from the connection on the lower rear corner of refrigerator to the water pipe. Add 7 ft (2.1 m) to allow for cleaning. Use 1/4" (6.35 mm) O.D. (outside diameter) copper tubing. Be sure both ends of copper tubing are cut square.
 5. Using a cordless drill, drill a 1/4" (6.35 mm) hole in the cold water pipe you have selected.

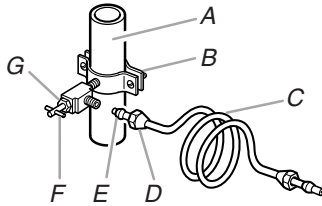

A. Cold water pipe
B. Pipe clamp
C. Copper tubing
D. Compression nut
E. Compression sleeve
F. Shutoff valve
G. Packing nut

6. Fasten the shutoff valve to the cold water pipe with the pipe clamp. Be sure the outlet end is solidly in the 1/4" (6.35 mm) drilled hole in the water pipe and that the washer is under the pipe clamp. Tighten the packing nut. Tighten the pipe clamp screws slowly and evenly so the washer makes a watertight seal. Do not overtighten, or you may crush the copper tubing.
7. Slip the compression sleeve and compression nut on the copper tubing as shown. Insert the end of the tubing into the outlet end squarely as far as it will go. Screw the compression nut onto outlet end with adjustable wrench. Do not overtighten.
8. Place the free end of the tubing in a container or sink, and turn ON the main water supply. Flush the tubing until water is clear. Turn OFF the shutoff valve on the water pipe. Coil the copper tubing.

Connect to Refrigerator

Style 1

1. Unplug refrigerator or disconnect power.
2. Remove and discard the short, black plastic part from the end of the water line inlet.
3. Thread the nut onto the end of the tubing. Tighten the nut by hand. Then tighten it with a wrench two more turns. Do not overtighten.

NOTE: To avoid rattling, be sure the copper tubing does not touch the cabinet's side wall or other parts inside the cabinet.

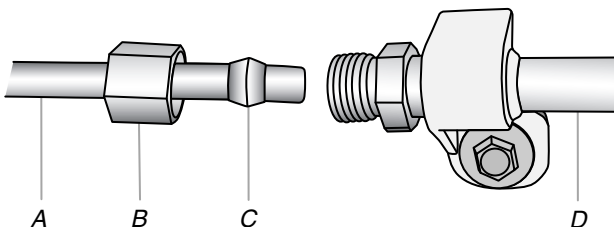

A. Household water line
B. Nut (purchased)
C. Ferrule (purchased)
D. Refrigerator water tubing

4. Install the water supply tube clamp around the water supply line to reduce strain on the coupling.
5. Turn shutoff valve ON.
6. Check for leaks. Tighten any connections (including connections at the valve) or nuts that leak.

Style 2

1. Unplug refrigerator or disconnect power.
2. Remove and discard the plastic part that is attached to the inlet of the water valve.
3. Attach the copper tube to the valve inlet using a compression nut and sleeve as shown. Tighten the compression nut. Do not overtighten.
4. Use the tube clamp on the back of the refrigerator to secure the tubing to the refrigerator as shown. This will help avoid damage to the tubing when the refrigerator is pushed back against the wall.
5. Turn shutoff valve ON.
6. Check for leaks. Tighten any connections (including connections at the valve) or nuts that leak.

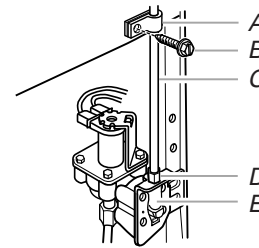

A. Tube clamp
B. Tube clamp screw
C. Copper tubing
D. Compression nut
E. Valve inlet

7. On some models, the ice maker is equipped with a built-in water strainer. If your water conditions require a second water strainer, install it in the 1/4" (6.35 mm) water line at either tube connection. Obtain a water strainer from your nearest appliance dealer.

Style 3

1. Unplug refrigerator or disconnect power.
2. Remove and discard the black nylon plug from the gray water tube on the rear of the refrigerator.
3. If the gray water tube supplied with the refrigerator is not long enough, a 1/4" x 1/4" (6.35 mm x 6.35 mm) coupling is needed in order to connect the water tubing to an existing household water line. Thread the provided nut onto the coupling on the end of the copper tubing.

NOTE: Tighten the nut by hand. Then tighten it with a wrench two more turns. Do not overtighten.

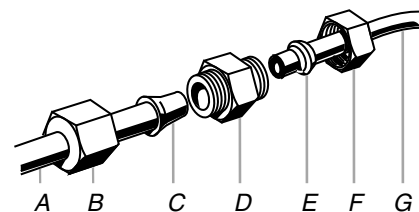

A. Refrigerator water tubing
B. Nut (provided)
C. Bulb
D. Coupling (purchased)
E. Ferrule (purchased)
F. Nut (purchased)
G. Household water line

4. Turn shutoff valve ON.
5. Check for leaks. Tighten any nuts or connections (including connections at the valve) that leak.

Complete the Installation

⚠ WARNING



Electrical Shock Hazard

Plug into a grounded 3 prong outlet.

Do not remove ground prong.

Do not use an adapter.

Do not use an extension cord.

Failure to follow these instructions can result in death, fire, or electrical shock.

1. Plug into a grounded 3 prong outlet.
2. Flush the water system. See “Water and Ice Dispensers” in the User Instructions or User Guide.

NOTE: Allow 24 hours to produce the first batch of ice. Allow 72 hours to completely fill ice container.

FILTERS AND ACCESSORIES

Install Air Filter (on some models)

On some models, your refrigerator's accessory packet includes an air filter, which must be installed prior to use. On some models, the air filter is already installed at the factory.

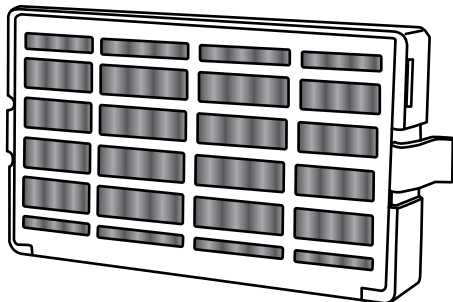

The air filter reduces the buildup of odors. This helps to maintain a cleaner environment inside the refrigerator.

Installing the Air Filter (on some models)

The filter should be installed behind the vented door, which is located (depending on your model) along either the rear or left interior wall near the top of the refrigerator compartment.

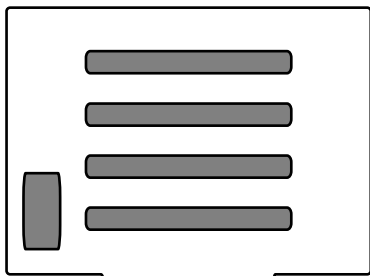

1. Remove the air filter from its packaging.
2. Lift open the vented door.
3. Snap the filter into place.

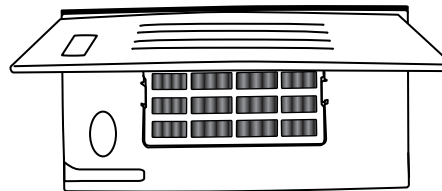

4. Close the vented door.

Installing the Filter Status Indicator (on some models)

The filter comes with a status indicator, which should be activated and installed at the same time the air filter is installed.

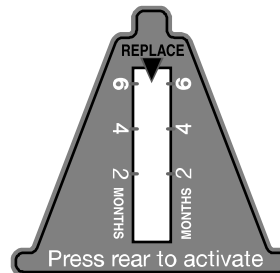

1. Place the indicator face-down on a firm, flat surface.
2. Apply pressure to the bubble on the back of the indicator, until the bubble pops to activate the indicator.
3. Lift open the vented air filter door. On some models, there are notches behind the door.
4. **On models with notches:**
 - Slide the indicator down into the notches, facing outward.

NOTE: The indicator will not easily slide into the notches if the rear bubble has not been popped.

 - Close the air filter door, and check that the indicator is visible through the rectangular hole in the door.

On models without notches:

 - Store the indicator in a visible place you will easily remember - either inside the refrigerator, or elsewhere in your kitchen or home.

Replacing the Air Filter

The disposable air filter should be replaced every 6 months, when the status indicator has completely changed from white to red.

To order a replacement air filter, see “Accessories” in the User Instructions or User Guide.

1. Remove the old air filter by squeezing in on the side tabs.
2. Remove the old status indicator.
3. Install the new air filter and status indicator using the instructions in the previous sections.

Install Produce Preserver (on some models)

On some models, your refrigerator's accessory packet includes a Produce Preserver, which should be installed prior to use. On some models, the Produce Preserver is already installed at the factory.

The Produce Preserver absorbs ethylene, allowing the ripening process of many produce items to slow down. As a result, certain produce items will stay fresh longer.

Ethylene production and sensitivity varies depending on the type of fruit or vegetable. To preserve freshness, it is best to separate produce with sensitivity to ethylene from fruits that produce moderate to high amounts of ethylene.

	Sensitivity to Ethylene	Ethylene Production
Apples	High	Very High
Asparagus	Med.	Very Low
Berries	Low	Low
Broccoli	High	Very Low
Cantaloupe	Med.	High
Carrots	Low	Very Low
Citrus Fruit	Med.	Very Low
Grapes	Low	Very Low
Lettuce	High	Very Low
Pears	High	Very High
Spinach	High	Very Low

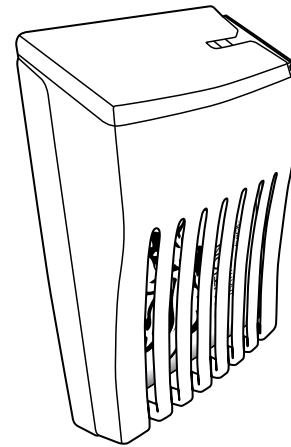

NOTE: For best performance, always use two pouches.

1. Remove the Produce Preserver pouches from their packaging.
2. Lift up on the housing in order to remove it from its mounting tab along the wall.
3. Open the housing by pulling up and out on the back of the top of the housing.
4. Place both pouches inside the housing, then snap the housing back together.
5. Place the housing back on the mounting tab along the wall.

Installing the Status Indicator (on some models)

The Produce Preserver comes with a status indicator, which should be activated and installed at the same time the pouch is installed.

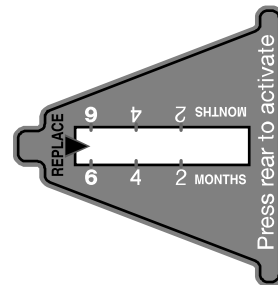

1. Place the indicator face-down on a firm, flat surface.
2. Apply pressure to the bubble on the back of the indicator, until the bubble pops to activate the indicator.
3. Slide open the cap on the Produce Preserver housing.
4. Place the indicator in the top of the housing, facing outward.
5. Slide the cap closed, and check that the indicator is visible through the rectangular hole in the cap.

NOTE: The cap will not easily close if the indicator's rear bubble has not been popped.

Replacing the Produce Preserver (on some models)

The disposable pouches should be replaced every 6 months, when the status indicator has completely changed from white to red.

To order replacements, see "Accessories" in the User Instructions or User Guide.

1. Remove the old pouches from the Produce Preserver housing.
2. Remove the old status indicator.
3. Install the new pouches and status indicator using the instructions in the previous sections.

Installing the Produce Preserver (on some models)

CAUTION: IRRITANT

MAY IRRITATE EYES AND SKIN. DANGEROUS FUMES FORM WHEN MIXED WITH OTHER PRODUCTS.

Do not mix with cleaning products containing ammonia, bleach or acids. Do not get in eyes, on skin or clothing. Do not breathe dust. Keep out of reach of children.

FIRST AID TREATMENT: Contains potassium permanganate. If swallowed, call a Poison Control Center or doctor immediately. Do not induce vomiting. If in eyes, rinse with water for 15 minutes. If on skin, rinse with water.

The Produce Preserver pouches should be installed in their housing, which is located along an interior side wall of the crisper or convertible drawer.

Changing the Water Filter

Do not use with water that is microbiologically unsafe or of unknown quality without adequate disinfection before or after the system. Systems certified for cyst reduction may be used on disinfected waters that may contain filterable cysts.

The water filter status light will help you know when to change your water filter. See “Water Filtration System” in the User Instructions or User Guide.

NOTE: If water flow to your water dispenser or ice maker decreases noticeably, change the filter sooner. The filter should be replaced at least every 6 months, depending on your water quality and usage.

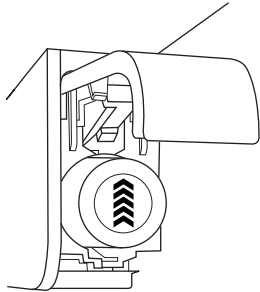

1. Locate the water filter in the top-right corner of the refrigerator compartment.
2. Lift open the filter cover door. The filter will be released and then be ejected as the door is opened.
3. When the door is completely open, pull the filter straight out.
NOTE: There may be some water in the filter. Some spilling may occur. Use a towel to wipe up any spills.
4. Take the new filter out of its packaging and remove the cap. Be sure the O-rings are still in place after the cap is removed.

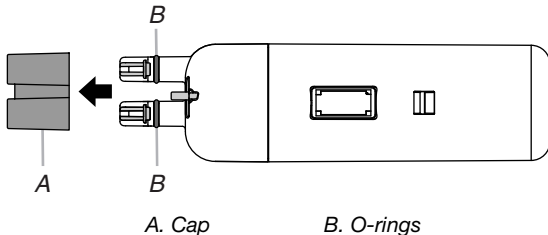

5. With the arrow pointing up, align the new filter with the filter housing and slide it into place. The filter cover door will automatically begin to close as the new filter is inserted.
6. Close the filter cover door completely in order to snap the filter into place. You may need to press hard.
7. After changing the filter, reset the filter status light. See “Water Filtration System” in the User Instructions or User Guide.
8. Flush the water system. See “Water and Ice Dispensers” in the User Instructions or User Guide.

REFRIGERATOR CARE

Cleaning

⚠ WARNING



Explosion Hazard

Use nonflammable cleaner.

Failure to do so can result in death, explosion, or fire.

Both the refrigerator and freezer sections defrost automatically. However, clean both sections about once a month to avoid buildup of odors. Wipe up spills immediately.

IMPORTANT: Because air circulates between both sections, any odors formed in one section will transfer to the other. You must thoroughly clean both sections to eliminate odors. To avoid odor transfer and drying out of food, wrap or cover foods tightly.

To Clean Your Refrigerator:

NOTE: Do not use abrasive or harsh cleaners such as window sprays, scouring cleansers, flammable fluids, cleaning waxes, concentrated detergents, bleaches or cleansers containing petroleum products on plastic parts, interior and door liners or gaskets. Do not use paper towels, scouring pads, or other harsh cleaning tools.

1. Unplug refrigerator or disconnect power.
2. Hand wash, rinse, and dry removable parts and interior surfaces thoroughly. Use a clean sponge or soft cloth and a mild detergent in warm water.
3. Wash stainless steel and painted metal exteriors with a clean sponge or soft cloth and a mild detergent in warm water.
4. There is no need for routine condenser cleaning in normal home operating environments. If the environment is particularly greasy or dusty, or there is significant pet traffic in the home, the condenser should be cleaned every 2 to 3 months to ensure maximum efficiency.

If you need to clean the condenser:

- Remove the base grille. See the “Door Removal” instructions, either in the User Instructions or the Installation Instructions and Owner’s Manual, or in the separate instruction sheet provided with your refrigerator.
 - Use a vacuum cleaner with a soft brush to clean the grille, the open areas behind the grille and the front surface area of the condenser.
 - Replace the base grille when finished.
5. Plug in refrigerator or reconnect power.

Lights

IMPORTANT: The refrigerator and freezer compartments, air tower and dispenser lights are LEDs that cannot be changed by yourself. To order replacement LED lightings, please, call Whirlpool service (1-800-253-1301 (U.S.A.) or 1-800-807-6777 (Canada).)

Light Styles:

The dispenser lights are mini LEDs that cannot be changed.
The interior lights vary by model.

- Some models have mini LEDs that cannot be changed.
- Some models have full-size LED bulbs that can be changed. To order replacement LED bulbs, call 1-800-253-1301 (U.S.A.) or 1-800-807-6777 (Canada).

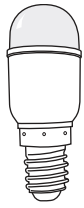

Whirlpool
Part Number
W10574850A
(2.0 watts)

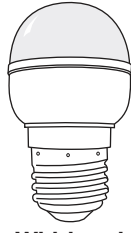

Whirlpool
Part Number
W10565137A
(3.6 watts)

NOTE: Some LED replacement bulbs are not recommended for wet/damp environments. The refrigerator and freezer compartments are considered to be wet/damp environments. If using a brand of LED bulb other than the recommended Whirlpool LED bulb, read and follow all instructions on the replacement bulb's packaging before installing it.

- Some models have incandescent 40-watt bulbs that can be changed.

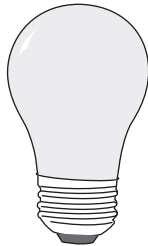

NOTE: Not all replacement bulbs will fit your refrigerator. Do not use an incandescent bulb in excess of 40 watts.

To Change a Light Bulb:

1. Unplug refrigerator or disconnect power.
2. Remove the light shield, as explained in the following sections.

NOTE: To clean the light shield, wash it with warm water and liquid detergent. Before reinstalling, thoroughly rinse and dry the shield.

3. Replace the burned-out light bulb, as explained in the following sections.
4. Reinstall the light shield, as explained in the following sections.
5. Plug in refrigerator or reconnect power.

Refrigerator Compartment - Upper Lights

Light Shield Removal:

- Slide the light shield toward the rear of the refrigerator and remove it from the light housing.

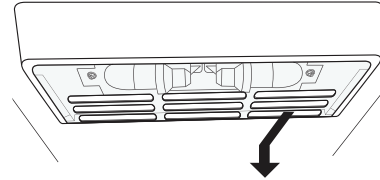

Replacement Bulb:

- If the burned-out light is a full-size LED bulb, replace it with Whirlpool part number W10574850A (a 2.0 watt LED bulb).
- If the burned-out light is an incandescent bulb, replace it with an incandescent appliance bulb of the same size, shape and wattage (40-watt maximum).

Light Shield Reinstallation:

- Align the light shield in the grooves at the bottom edge of the light housing, then slide it forward until it snaps into place.

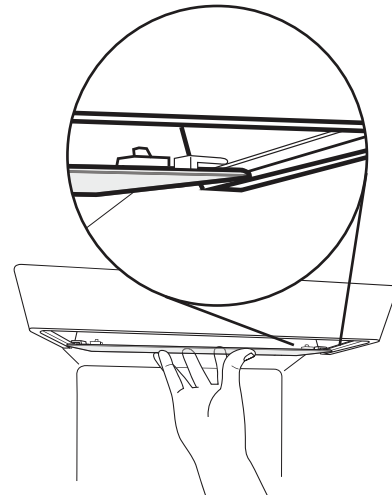

Refrigerator Compartment - Lower Lights

Light Shield Removal:

- Slide the light shield to the right to remove the left end from the wall slots, then pull the right end out of its wall slots.

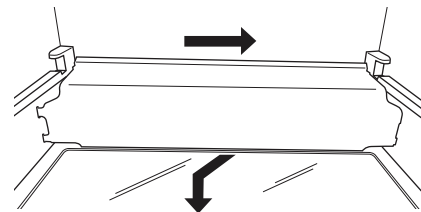

Replacement Bulb:

- If the burned-out light is a full-size LED bulb, replace it with Whirlpool part number W10565137A (a 3.6 watt LED bulb).
- If the burned-out light is an incandescent bulb, replace it with an incandescent appliance bulb of the same size, shape and wattage (40-watt maximum).

Light Shield Reinstallation:

- Place the right end of the light shield into the wall slots, then snap the left end into its wall slots.

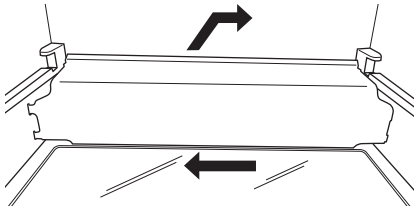

Freezer Compartment - Upper Light

Light Shield Removal:

- Gently squeeze the front and the bottom-rear edge of the light shield to release the tabs from the wall slots, and then pull the light shield forward.

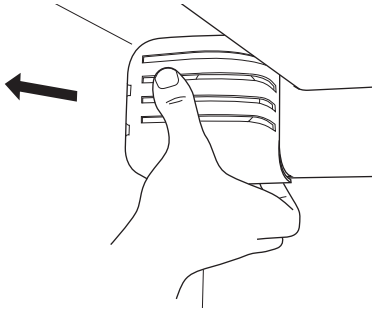

Replacement Bulb:

- If the burned-out light is a full-size LED bulb, replace it with Whirlpool part number W10565137A (a 3.6 watt LED bulb).
- If the burned-out light is an incandescent bulb, replace it with an incandescent appliance bulb of the same size, shape and wattage (40-watt maximum).

Light Shield Reinstallation:

- Align the light shield in its proper position, and snap the tabs into the wall slots.

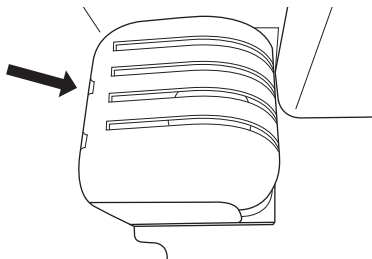

Freezer Compartment - Lower Light

Light Shield Removal:

- Slide the light shield to the left to remove the right end from the wall slots, then pull the left end out of its wall slots.

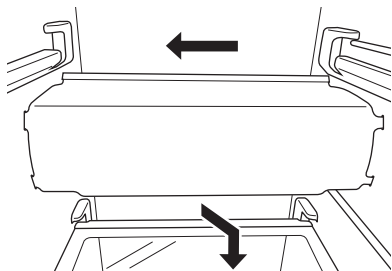

Replacement Bulb:

- If the burned-out light is a full-size LED bulb, replace it with Whirlpool part number W10565137A (a 3.6 watt LED bulb).
- If the burned-out light is an incandescent bulb, replace it with an incandescent appliance bulb of the same size, shape and wattage (40-watt maximum).

Light Shield Reinstallation:

- Place the left end of the light shield into the wall slots, then snap the right end into its wall slots.

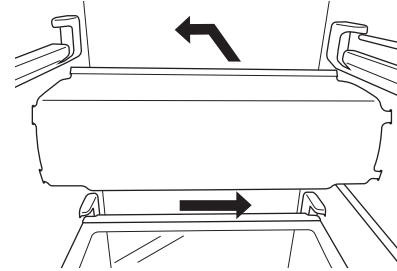

Vacation and Moving Care

Vacations

If You Choose to Leave Refrigerator On While You Are Away:

1. Use up any perishables and freeze other items.
2. If your refrigerator has an automatic ice maker and is connected to the household water supply, turn off the water supply to the refrigerator. Property damage can occur if the water supply is not turned off.
3. If you have an automatic ice maker, turn off the ice maker.
NOTE: Depending on your model, raise the wire shutoff arm to OFF (up) position or press the switch to OFF.
4. Empty the ice bin.

If You Choose to Turn Refrigerator Off Before You Leave:

1. Remove all food from the refrigerator.
2. If your refrigerator has an automatic ice maker:
 - Turn off the water supply to the ice maker at least one day ahead of time.
 - When the last load of ice drops, raise the wire shutoff arm to the OFF (up) position or move the switch to the OFF setting.
3. Depending on the model, turn the Refrigerator Control to OFF or turn cooling off. See "Using the Controls" in the User Instructions, User Guide, or Use & Care Guide.
4. Clean, wipe, and dry thoroughly.
5. Tape rubber or wood blocks to the tops of both doors to prop them open far enough for air to get in. This stops odor and mold from building up.

Moving

When you are moving your refrigerator to a new home, follow these steps to prepare it for the move.

1. If your refrigerator has an automatic ice maker:
 - Turn off the water supply to the ice maker at least one day ahead of time.
 - Disconnect the water line from the back of the refrigerator.
 - When the last load of ice drops, raise the wire shutoff arm to the OFF (up) position or move the switch to the OFF setting.
2. Remove all food from the refrigerator and pack all frozen food in dry ice.
3. Empty the ice bin.

4. Depending on the model, turn the Refrigerator Control to OFF or turn cooling off. See “Using the Controls” in the User Instructions, User Guide, or Use & Care Guide.
 5. Unplug refrigerator.
 6. Clean, wipe, and dry thoroughly.
 7. Take out all removable parts, wrap them well, and tape them together so they don't shift and rattle during the move.
 8. Depending on the model, raise the front of the refrigerator so it rolls more easily OR screw in the leveling legs so they don't scrape the floor. See “Adjust the Doors” or “Door Removal, Leveling and Alignment.”
 9. Tape the doors closed and tape the power cord to the back of the refrigerator.
- When you get to your new home, put everything back and refer to the Installation Instructions for preparation instructions. Also, if your refrigerator has an automatic ice maker, remember to reconnect the water supply to the refrigerator.

PROBLEM SOLVER

First try the solutions suggested here or visit our website to possibly avoid the cost of a service call.

⚠ WARNING



Electrical Shock Hazard

Plug into a grounded 3 prong outlet.

Do not remove ground prong.

Do not use an adapter.

Do not use an extension cord.

Failure to follow these instructions can result in death, fire, or electrical shock.

GENERAL OPERATION	Possible Causes and/or Recommended Solutions
Refrigerator will not operate	<ul style="list-style-type: none"> ■ Not connected to an electrical supply - Plug the power cord into a grounded 3 prong outlet. Do not use an extension cord. ■ No power to the electrical outlet - Plug in a lamp to see if the outlet is working. ■ Household fuse has blown or circuit breaker has tripped - Replace the fuse or reset the circuit breaker. If the problem continues, contact a licensed electrician. ■ Control or cooling is not turned on - Turn on the refrigerator control, or turn cooling on. See “Using the Controls” in the User Instructions or User Guide. ■ New installation - Following installation, allow 24 hours for the refrigerator and freezer to cool completely. NOTE: Adjusting the temperature control(s) to the coldest setting will not cool either compartment (refrigerator or freezer) more quickly.
Motor seems to run too much	<ul style="list-style-type: none"> ■ Your new refrigerator has an energy-efficient motor - The refrigerator may run longer than you're used to, because the compressor and fans operate at lower speeds that are more energy-efficient. This is normal. NOTE: Your refrigerator may run even longer if the room is warm, a large load of food is added, the doors are opened often, or if a door has been left open.

GENERAL OPERATION Possible Causes and/or Recommended Solutions

Refrigerator seems noisy

The compressor in your new refrigerator regulates temperature more efficiently and uses less energy than older models. During various stages of operation, you may hear normal operating sounds that are unfamiliar.

The following noises are normal:

- **Buzzing/Clicking** - Heard when the water valve opens and closes to dispense water or fill the ice maker. If the refrigerator is connected to a water line, this is normal. If the refrigerator is not connected to a water line, turn off the ice maker.
- **Cracking/Crashing** - Heard when ice is ejected from the ice maker mold.
- **Popping** - Heard when the inside walls contract/expand, especially during initial cooldown.
- **Pulsating/Whirring** - Heard when the fans/compressor adjust to optimize performance during normal operation.
- **Rattling** - Heard when water passes through the water line or due to the flow of refrigerant. Rattling may also come from items placed on top of the refrigerator.
- **Water running or gurgling** - Heard when ice melts during the defrost cycle and water runs into the drain pan.
- **Sizzling** - Heard when water drips onto the heater during the defrost cycle.

Temperature is too warm

- **New installation** - Following installation, allow 24 hours for the refrigerator and freezer to cool completely.
NOTE: Adjusting the temperature control(s) to the coldest setting will not cool either compartment (refrigerator or freezer) more quickly.
- **Doors are opened often or not closed completely** - This allows warm air to enter the refrigerator. Minimize door openings, keep the doors fully closed, and make sure both doors are properly sealed.
- **Air vents are blocked** - Remove items that are immediately in front of the vents.
- **Large amount of warm food recently added** - Allow several hours for the refrigerator to return to its normal temperature.
- **Controls are not set correctly for the surrounding conditions** - Adjust the controls to a colder setting. Check the temperature again in 24 hours.

Temperature is too cold

- **Controls are not set correctly for the surrounding conditions** - Adjust the controls to a warmer setting. Check the temperature again in 24 hours.
- **Top refrigerator shelf is colder than lower shelves** - On some models, air from the freezer enters the refrigerator compartment through vents near the top refrigerator shelf. As a result, the top shelf can be slightly colder than lower shelves.
- **Air vents are blocked** - Remove items that are immediately in front of the vents.

Interior moisture buildup

- NOTE:** Some moisture buildup is normal. Clean with a soft dry cloth.
- **Room is humid** - A humid environment contributes to moisture buildup. Use the refrigerator only in an indoor location with as little humidity as possible.
 - **Doors are opened often or not closed completely** - This allows humid air to enter the refrigerator. Minimize door openings, keep the doors fully closed, and make sure both doors are properly sealed.

Interior lights do not work

- **Doors have been open for an extended period of time** - Close the doors to reset the lights.
 - **Light bulb is loose in the socket or has burned out** - On models with incandescent or full-size LED interior light bulbs, tighten or replace the bulb. See "Lights."
- NOTE:** On models with mini LED lights, call for assistance or service if the interior lights do not illuminate when either door is opened. See the Warranty in the User Instructions or User Guide for contact information.

Dispenser lights do not work (on some models)

- **Dispenser light is turned off** - On some models, if the dispenser light is set to OFF, the light will turn on only when a dispenser pad/lever is pressed. If you want the dispenser light to stay on continuously, select a different setting. See "Water and Ice Dispensers" in the User Instructions or User Guide.
 - **Dispenser light is set to AUTO or NIGHT LIGHT** - On some models, if the dispenser light is set to AUTO or NIGHT LIGHT, make sure the dispenser light sensor is not blocked. See "Water and Ice Dispensers" in the User Instructions or User Guide.
- NOTE:** On models with mini LED lights, call for assistance or service if the dispenser lights do not operate correctly. See the Warranty in the User Instructions or User Guide for contact information.
-

⚠ WARNING



Explosion Hazard

Use nonflammable cleaner.
Failure to do so can result in death, explosion, or fire.

DOORS AND LEVELING	Possible Causes and/or Recommended Solutions
Doors are difficult to open	<ul style="list-style-type: none"> ■ Gaskets are dirty or sticky - Clean the gaskets and contact surfaces with mild soap and warm water. Rinse and dry with a soft cloth.
Doors will not close completely	<ul style="list-style-type: none"> ■ Door is blocked open - Move food packages away from the door. Make sure all bins and shelves are in their correct positions. Make sure all packaging materials have been removed.
Doors appear to be uneven	<ul style="list-style-type: none"> ■ Doors need to be aligned, or refrigerator needs to be leveled - See the leveling and door alignment instructions.
Refrigerator rocks and is not stable	<ul style="list-style-type: none"> ■ Refrigerator is not level - To stabilize the refrigerator, remove the base grille and lower the leveling feet until they touch the floor. See the leveling and door alignment instructions.

⚠ WARNING



Cut Hazard

Use a sturdy glass when dispensing ice.
Failure to do so can result in cuts.

ICE AND WATER	Possible Causes and/or Recommended Solutions
Ice maker is not producing ice, not producing enough ice, or producing small/hollow ice	<ul style="list-style-type: none"> ■ Refrigerator is not connected to a water supply, or the water supply shutoff valve is not fully turned on - Connect the refrigerator to a water supply and make sure the water shutoff valve is fully open. ■ Kink in the water source line - A kink in the water line can reduce water flow, resulting in decreased ice production, small ice cubes, and/or hollow or irregularly-shaped ice. Straighten the water line. ■ Ice maker is not turned on - Turn on the ice maker. See “Ice Maker and Storage Bin” in the User Instructions or User Guide. ■ New installation - After connecting the refrigerator to a water source, flush the water system. (See “Water and Ice Dispensers” in the User Instructions or User Guide.) Wait 24 hours for ice production to begin. Wait 72 hours for full ice production. Discard the first three batches of ice produced. ■ Large amount of ice was recently removed - Allow sufficient time for the ice maker to produce more ice. ■ Ice is jammed in the ice maker ejector arm (on some models) - Remove ice from the ejector arm using a plastic utensil. ■ Inadequate water pressure - Verify that the household has adequate water pressure. See “Water Supply Requirements.” ■ Water filter is installed incorrectly - Make sure the filter is properly installed. See “Water Filtration System” in the User Instructions or User Guide. ■ A reverse osmosis water filtration system is connected to your cold water supply - This can decrease water pressure. See “Water Supply Requirements.” <p>NOTE: If questions remain regarding water pressure, contact a licensed, qualified plumber.</p>

ICE AND WATER**Possible Causes and/or Recommended Solutions**

Ice dispenser will not operate properly

- **Doors not closed completely** - Make sure both doors are firmly closed. (On some models, only the freezer door must be closed in order to operate the dispenser.)
- **New installation** - After connecting the refrigerator to a water source, flush the water system. (See “Water and Ice Dispensers” in the User Instructions or User Guide.) Wait 24 hours for ice production to begin. Wait 72 hours for full ice production. Discard the first three batches of ice produced.
- **Ice maker is not turned on, or ice bin is not installed correctly** - Turn on the ice maker and make sure the ice storage bin is firmly in position. See “Ice Maker and Storage Bin” in the User Instructions or User Guide.
- **Ice is clogged or frozen together in the ice storage bin, or ice is blocking the ice delivery chute** - Remove or separate the clogged ice, using a plastic utensil if necessary. Clean the ice delivery chute and the bottom of the ice storage bin using a warm damp cloth, and then dry both thoroughly. To avoid clogging and to maintain a fresh supply of ice, empty the storage bin and clean both the storage bin and the delivery chute every 2 weeks.
- **Wrong ice has been added to the storage bin** - Use only ice cubes produced by the current ice maker.
- **Dispenser is locked** - Unlock the dispenser. See “Water and Ice Dispensers” in the User Instructions or User Guide.
- **Ice dispenser jams while dispensing crushed ice** - For models with the ice storage bin on the door, temporarily switch from crushed ice to cubed ice to clear the jam.
- **Dispenser pad/lever has been pressed too long** - Ice will automatically stop dispensing. Wait a few minutes for the dispenser to reset, then resume dispensing. Take large amounts of ice directly from the ice bin, not through the dispenser.
- **Water pressure to the home is not at or above 30 psi (207 kPa)** - The water pressure to the home affects the flow from the dispenser. See “Water Supply Requirements.”
- **Water filter is clogged or incorrectly installed** - Replace filter or reinstall it correctly. See “Water Filtration System” in the User Instructions or User Guide.

Ice or water has an off-taste, odor, or gray color

- **New plumbing connections** - New plumbing connections can result in off-flavored or discolored ice or water. This problem should go away over time.
- **Ice has been stored too long** - Discard the ice and wash the ice bin. Allow 24 hours for the ice maker to produce new ice.
- **Odor has transferred from food** - Use airtight moisture-proof packaging to store food.
- **Use of non-recommended water supply line** - Odors and tastes can transfer from certain materials used in non-recommended water supply lines. Use only a recommended water supply line. See “Water Supply Requirements.”
- **There are minerals (such as sulfur) in the water** - A water filter may need to be installed in order to remove the minerals.
- **Water filter was recently installed or replaced** - Gray or dark discoloration in ice or water indicates that the water filtration system needs additional flushing. See “Water and Ice Dispensers” in the User Instructions or User Guide.

Water dispenser will not operate properly

- **Doors not closed completely** - Make sure both doors are firmly closed. (On some models, only the freezer door must be closed in order to operate the dispenser.)
- **Refrigerator is not connected to a water supply, or the water supply shutoff valve is not turned on** - Connect the refrigerator to a water supply and make sure the water shutoff valve is fully open.
- **Kink in the water source line** - A kink in the water line can reduce water flow to the dispenser. Straighten the water line.
- **Water pressure to the home is not at or above 30 psi (207 kPa)** - The water pressure to the home affects the flow from the dispenser. See “Water Supply Requirements.”
- **New installation** - After connecting the refrigerator to a water source, flush the water system. See “Water and Ice Dispensers” in the User Instructions or User Guide.
- **Dispenser is locked** - Unlock the dispenser. See “Water and Ice Dispensers” in the User Instructions or User Guide.
- **Water filter is clogged or incorrectly installed** - Replace filter or reinstall it correctly. See “Water Filtration System” in the User Instructions or User Guide.
- **A reverse osmosis water filtration system is connected to your cold water supply** - This can decrease water pressure. See “Water Supply Requirements.”

NOTE: If questions remain regarding water pressure, contact a licensed, qualified plumber.

ICE AND WATER**Possible Causes and/or Recommended Solutions**

Water is leaking or dripping from the dispenser

NOTE: After dispensing, a few additional drops of water are normal.

- **Glass was not held under the dispenser long enough** - Hold the glass under the dispenser for 2 to 3 seconds after releasing the dispenser pad/lever.
- **New installation, or water filter was recently installed or replaced** - Air in the water lines causes the water dispenser to drip. Flush the water system to remove the air in the water lines. See “Water and Ice Dispensers” in the User Instructions or User Guide.
- **Residual ice in the dispenser chute is melting** - Make sure the ice chute is free of ice shavings or pieces.

Water is leaking from the back of the refrigerator

- **Water line connections are not fully tightened** - Make sure all connections are firmly tightened. See “Connect Water Supply.”

Water from the dispenser is not cool enough (on some models)

NOTE: Water from the dispenser is chilled to 50°F (10°C).

- **New installation** - Allow 24 hours after installation for the water supply to cool completely.
 - **Recently dispensed a large amount of water** - Allow 24 hours for the new water supply to cool completely.
 - **Water has not been recently dispensed** - The first glass of water may not be cool. Discard the first glass of water dispensed.
 - **Refrigerator is not connected to a cold water pipe** - Make sure the refrigerator is connected to a cold water pipe. See “Water Supply Requirements.”
-

PERFORMANCE DATA SHEET

Water Filtration System Model P8WB2L/P8RFB2L Capacity 200 Gallons (757 Liters)



System tested and certified by NSF International against NSF/ANSI Standard 42, Standard 53, and Standard 401 for the reduction of contaminants specified on the Performance Data Sheet.

This system has been tested according to NSF/ANSI Standards 42, 53 and 401 for the reduction of the substances listed below. The concentration of the indicated substances in water entering the system was reduced to a concentration less than or equal to the permissible limit for water leaving the system, as specified in NSF/ANSI Standards 42, 53, and 401.

Substance Reduction Aesthetic Effects	Influent Challenge Concentration	Maximum Permissible Product Water Concentration	Average% Reduction
Chlorine Taste/Odor	2.0 mg/L ± 10%	50% reduction	97.0%
Particulate Class I*	At least 10,000 particles/mL	85% reduction	>99.9%
Contaminant Reduction	Influent Challenge Concentration	Maximum Permissible Product Water Concentration	Average% Reduction
Lead: @ pH 6.5 / @ pH 8.5	0.15 mg/L ± 10%	0.010 mg/L	>99.3% / 98.6%
Benzene	0.015 mg/L ± 10%	0.005 mg/L	93.8%
p-Dichlorobenzene	0.225 mg/L ± 10%	0.075 mg/L	99.8%
Carbofuran	0.08 mg/L ± 10%	0.040 mg/L	81.9%
Toxaphene	0.015 ± 10%	0.003 mg/L	>95%
Atrazine	0.009 mg/L ± 10%	0.003 mg/L	87.0%
Asbestos	10 ⁷ to 10 ⁸ fibers/L ^{††}	99%	>99%
Live Cysts [†]	50,000/L min.	99.95%	>99.99%
Turbidity	11 NTU ± 10%	0.5 NTU	96.9%
Lindane	0.002 ± 10%	0.0002 mg/L	>99.2%
Tetrachloroethylene	0.015 mg/L ± 10%	0.005 mg/L	96.6%
o-Dichlorobenzene	1.8 mg/L ± 10%	0.60 mg/L	92.3%
Ethylbenzene	2.1 mg/L ± 10%	0.70 mg/L	86.9%
1,2,4-Trichlorobenzene	0.210 mg/L ± 10%	0.07 mg/L	>99.8%
2,4 - D	0.210 mg/L ± 10%	0.07 mg/L	88.5%
Styrene	2.0 mg/L ± 10%	0.1 mg/L	99.6%
Toluene	3.0 mg/L ± 10%	1.0 mg/L	93.5%
Endrin	0.006 mg/L ± 10%	0.002 mg/L	81.7%
Atenolol	200 ± 20%	30 ng/L	95.7%
Trimethoprim	140 ± 20%	20 ng/L	96.1%
Linuron	140 ± 20%	20 ng/L	96.3%
Estrone	140 ± 20%	20 ng/L	95.3%
Nonylphenol	1400 ± 20%	200 ng/L	95.5%

Test Parameters: pH = 7.5 ± 0.5 unless otherwise noted. Flow = 0.75 gpm (2.84 Lpm). Pressure = 60 psig (413.7 kPa). Temp. = 68°F to 71.6°F (20°C to 22°C). Rated service capacity = 200 gallons (757 liters).

The compounds certified under NSF 401 have been deemed as “emerging compounds/incidental contaminants.” Emerging compounds/incidental contaminants are those compounds that have been detected in drinking water supplies at trace levels. While occurring at only trace levels, these compounds can affect the public acceptance/perception of drinking water quality.

- It is important that operational, maintenance, and filter replacement requirements be carried out for the product to perform as advertised. Property damage can occur if all instructions are not followed.
- The disposable cartridge must be changed at least every 6 months.
- Use replacement filter P8RFB2L, part #EDR1RXD1/EDR1RXD1B. 2015 suggested retail price of \$49.99 U.S.A./\$49.99 Canada. Prices are subject to change without notice.
- The filter monitor system measures the amount of water that passes through the filter and alerts you when it is time to replace the filter. Refer to the “Using the Controls” or “Water Filtration System” section (in the User Instructions or User Guide) to learn how to check the water filter status.
- After changing the water filter, flush the water system. See “Water and Ice Dispensers” or “Water Dispenser” in the User Instructions or User Guide.
- These contaminants are not necessarily in your water supply. While testing was performed under standard laboratory conditions, actual performance may vary.
- The product is for cold water use only.
- The water system must be installed in compliance with state and local laws and regulations.
- Do not use with water that is microbiologically unsafe or of unknown quality without adequate disinfection before or after the system. Systems certified for cyst reduction may be used on disinfected waters that may contain filterable cysts. EPA Est. No. 082047-TWN-001
- Refer to the “Warranty” section (in the User Instructions or User Guide) for the Manufacturer’s limited warranty, name and telephone number.

Application Guidelines/Water Supply Parameters

Water Supply	City or Well
Water Pressure	30 - 120 psi (207 - 827 kPa)
Water Temperature	33° - 100°F (0.6° - 37.8°C)
Service Flow Rate	0.75 gpm (2.84 L/min.) @ 60 psi

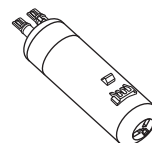

*Class I particle size: >0.5 to <1 µm

[†]Based on the use of *Cryptosporidium parvum* oocysts

^{††}Fibers greater than 10 µm in length