

Table of Contents

1 Description	16
1.1 General Description	16
1.2 Control panel	17
1.3 Microwaves	18
1.4 Other parts	18
1.5 Available accessories	19
2 Use	20
2.1 Instructions	20
2.2 Materials suitable for microwaves	20
2.3 First use	22
2.4 Using the accessories	22
2.5 Using the oven	23
2.6 Special functions	36
2.7 Automatic programs	41
2.8 Secondary menu	44
3 Cleaning and maintenance	47
3.1 Instructions	47
3.2 Cleaning the surfaces	47
3.3 Cleaning the door glazing	48
3.4 Cleaning the oven cavity	48
3.5 Vapor Clean	50

IMPORTANT SAFETY INSTRUCTIONS

WARNING: If the instructions contained in this manual are not followed precisely, fire or explosion may result causing property damage, personal injury or loss of life.



READ AND SAVE THESE INSTRUCTIONS - Your safety and the safety of others are very important.

We have provided many important safety messages throughout this manual and on the appliance.

Read all the instructions before using the appliance and always obey all safety messages.



Important Safety Instructions



RECOGNIZE SAFETY INFORMATION

This is a safety alert symbol. This symbol alerts you to potential hazards that can result in severe personal injury or loss of life.

UNDERSTAND SIGNAL WORDS

A signal word - DANGER, WARNING or CAUTION - is used with the safety alert symbol. DANGER denotes the most serious hazards. It means you could lose your life or be seriously injured if you do not immediately follow the instructions. WARNING means you could lose your life or be seriously injured if the instructions are not followed. CAUTION indicates a potentially hazardous situation which, if not avoided, could result in minor to moderate injury.

WARNING



- **This appliance is intended for use in the home only.**
- **Use this appliance only for its intended purpose. The manufacturer cannot be held liable for damage caused by improper use of this appliance.**
- **This appliance complies with current safety regulations. Improper use of this appliance can result in personal injury and material damage.**
- **Read all the instructions before installing or using the appliance for the first time.**
- **Keep these operating instructions in a safe place and pass them on to any future user.**

The safety messages will inform you of potential hazards, on how to avoid the risk of injury and what can occur if the instructions are not followed.

IMPORTANT: Observe all codes and ordinances in force.

WARNING: For your safety, the instructions contained in this manual must be followed to minimize the risk of fire or explosion and to prevent property damage, personal injury or loss of life.

Do not store or use gasoline or other flammable vapors, liquids or materials near this or any other appliance.



NOTE: This appliance is NOT designed for installation in manufactured (mobile) homes or in recreational vehicles (RVs).

DO NOT install this appliance outdoors.

Do not use this product near water (for example: near a kitchen sink, in a wet basement, near a swimming pool or similar locations).

Important Safety Instructions



WARNING



To reduce the risk of fire, electrical shock, personal injury, or damage when using the appliance, follow basic safety precautions, including the following:

NE



NOTE: The microwave power output is 1000 W.

- Read all instructions.
- Read and follow the specific “precautions to avoid possible exposure to excessive microwave energy” found on this manual.
- Proper installation is your responsibility. Have a qualified technician install and ground this appliance in accordance with these installation instructions.
- It is the responsibility of the installer to comply with installation information specified on the model/serial ID plate. The ID plates are visibly located on the back of the appliance and on the oven door frame. These ID plates must never be removed.
- Proper installation is your responsibility. Make sure your appliance is properly installed and grounded by a qualified installer.
- **WARNING: NEVER** use this appliance as a space heater to heat or warm the room. Doing so may result in overheating of the oven.
- **DO NOT LEAVE CHILDREN UNATTENDED:** Children should not be left alone or unattended in the area where the appliance is being used. Never allow children to sit or stand on any part of the appliance.
- **CAUTION:** Do not store items of interest to children in cabinets above a range or on the backguard of a range - children climbing on the range to reach items could be seriously injured.
- **WEAR PROPER APPAREL:** Loose-fitting or hanging garments should never be worn while using the appliance.
- For safety reasons and to avoid damage to your appliance, never sit, stand or lean on the oven door.



Important Safety Instructions

- **FLAMMABLE MATERIALS SHOULD NEVER BE STORED IN THE OVEN.**
- Do not obstruct oven vents or openings for air intake.
- Prevent aluminum foil from contacting the heating elements.
- **DO NOT TOUCH THE INSIDE OF THE APPLIANCE:** Heating elements may be hot even though they are dark in color. The oven cavity can be hot enough to cause burns. During and after use, do not touch areas inside of the oven until they have had sufficient time to cool. Do not allow garments or any flammable material to come into contact with hot surfaces. If personal clothing or hair catches on fire, drop and roll immediately to extinguish the flames.
- **PLACE THE OVEN RACKS IN THE DESIRED POSITION WHILE THE OVEN IS COOL:** If a rack must be removed while the oven is hot, do not allow the potholders to come in contact with the broiler burner.
- **USE CAUTION WHEN OPENING THE OVEN DOOR:** Allow hot air or steam to escape before removing or placing foods in the oven.
- Do not leave the packing materials around the home. Sort the various items of waste and take them to the nearest specialized waste collection facility.
- **ELECTRICAL GROUNDING IS REQUIRED.** It is the customer's responsibility:
 1. To contact a qualified electrician.
 2. To ensure that the electrical system is adequate and in compliance with the National Electrical Code ANSI / NFPA 70 Electrical Code – latest edition – or the CANADIAN ELECTRICAL CODE, C22.11 – 1982 and C22.2 No. 01982 – or latest edition – and all local codes and ordinances.
- Always check that the controls are in the "zero" (off) position when the oven is not in use.

Important Safety Instructions



- Do not attempt to repair or replace any part of this appliance unless specifically recommended in this manual. All other servicing should be done by a qualified technician.
- Never use any part of the oven for storage. Flammable materials can ignite and plastic items may melt or burst into flame.
- Do not hang articles on any part of the appliance or place anything against the oven. Some fabrics are extremely flammable and could ignite.
- **DO NOT USE ALUMINUM FOIL TO LINE ANY PART OF THE OVEN.** Use of a foil liner can result in an electrical shock or fire hazard or obstruct the flow of heat and air. Foil is an excellent heat insulator, allowing heat to be trapped under it. This can interfere with cooking and can damage the enamel of the oven.
- Do not cover or block any openings on the appliances.
- **DO NOT HEAT UNOPENED FOOD CONTAINERS:** A buildup of pressure can cause the containers to burst.
- **DO NOT USE FLAMMABLE PRODUCTS TO CLEAN THE OVEN.**
- Do not clean, rub, damage or remove the oven door gasket. It is essential for a good, tight seal during baking and when the self-clean cycle is engaged. Replace the oven door gasket if it becomes damaged or encrusted with food residue.
- **ONLY QUALIFIED SERVICE PERSONNEL SHOULD PERFORM REPAIRS.** Service personnel must disconnect the power supply before servicing this unit.



Important Safety Instructions



State of California Proposition 65 Warnings

NOTE: The California Safe Drinking Water and Toxic Enforcement Act requires the Governor of California to publish a list of substances known to the State of California to cause cancer, birth defects or other reproductive harm, and requires businesses to warn customers of potential exposure to such substances.

WARNING: This product contains a chemical known by the State of California to cause cancer, birth defects or other reproductive harm.

This appliance can cause low-level exposure to some of the substances listed, including benzene, formaldehyde, carbon monoxide, toluene, and soot.

- Do Not Use Water on Grease Fires - Smother fire or flame or use dry chemical or foam-type extinguisher.
- Remove all packing materials and temporary labels from the oven.
- Use Only Dry Potholders - Moist or damp potholders on hot surfaces may result in burns from steam. Do not let potholder touch hot heating elements. Do not use a towel or other bulky cloth.
- Do not stand or sit on the oven door.
- Record the Model and Serial number on Page 2 of this booklet. The Model and Serial numbers are on the appliance ID plate. The ID plates are visibly located on the oven door frame. THE ID PLATE MUST NOT BE REMOVED.
- BEFORE BAKING FOR THE FIRST TIME, turn on the oven to burn off any dirt, oil or grease remaining from the manufacturing process. Turn the oven on and set to 450°F for 20 to 30 minutes.



Risk of personal injury

- **ATTENTION:** If the door or the door seal is damaged, the oven must not be used until it has been repaired by a competent person.
- **ATTENTION:** It is hazardous for anyone other than a competent person to carry out any service or repair operation which involves the removal of a cover which offers protection against exposure to microwave energy.
- Switch off the appliance immediately after use.
- **ATTENTION:** Liquids and other foods must not be heated in sealed containers since they are liable to explode.
- **ATTENTION:** During use, the appliance and its accessible parts become very hot.
- Never touch the heating elements during use.
- Keep children under the age of 8 at a safe distance unless they are constantly supervised.
- This appliance may be used by children aged at least 8 and by people of reduced physical, sensory or mental capacity, or lacking in experience in the use of electrical appliances, provided that they are supervised or instructed by adults who are responsible for their safety.
- Children must not play with the appliance.
- Cleaning and maintenance must not be carried out by unsupervised children.
- Never attempt to extinguish a flame or fire with water.
- Do not modify this appliance.
- Do not insert pointed metal objects (cutlery or utensils) into the slots in the appliance.
- If smoke is emitted, switch off or unplug the appliance and keep the door closed in order to stifle any flames.
- **Installation and servicing should be carried out by qualified personnel in accordance with current standards.**
- Do not try to repair the appliance yourself or without the assistance of a qualified technician.



Important Safety Instructions

- If the power supply cable is damaged, contact technical support immediately and they will replace it.
- Do not immerse cord or plug in water.
- Keep cord away from heated surfaces.
- Do not let cord hang over edge of table or counter.
- If materials inside the oven ignite, keep oven door closed, turn oven off and disconnect the power cord or shut off power at the fuse or circuit breaker panel.
- Do not use steam jets to clean the appliance.

Risk of damaging the appliance

- Do not use abrasive or corrosive detergents (e.g. scouring powders, stain removers and metallic sponges) on glass parts.
- Use wooden or plastic utensils.
- Do not overcook food. Carefully attend appliance when paper, plastic or other combustible materials are placed inside the oven to facilitate cooking.
- Remove wire twist-ties from paper or plastic bags before placing bag in oven.
- Do not obstruct ventilation openings and heat dispersal slots.
- Never leave the appliance unattended during cooking operations where fats or oils could be released.
- Do not use the appliance to heat rooms for any reason.
- Do not rest any weight or sit on the open door of the appliance.
- Take care that no objects are stuck in the doors.

Important Safety Instructions



Instructions for using microwaves

- Check the appliance visually during the cooking of foods in plastic or paper containers.



**Improper use.
Danger of explosion**

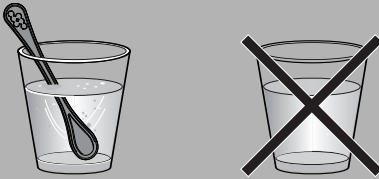

- When using the microwave to heat or reheat liquids, the boiling process may be delayed – boiling temperature can be reached without the formation of the usual "rolling boil". This delayed boiling and consequent superheating of the liquid can generate an explosion inside the appliance, or sudden boiling over of the superheated liquid can occur when removing the container from the appliance. To avoid these dangers, it is necessary to insert the supplied boiling rod (or a heat-resistant plastic spoon) in the container while heating.

- Use the microwave only for the preparation of food for consumption. Other types of applications are strictly forbidden (e.g. drying clothes, warming slippers, sponges, wet cloths or the like, dehydrating foods) because they can lead to the risk of injury or fire.

Precautions To Avoid Possible Exposure To Excessive Microwave Energy

- (a) Do not attempt to operate this oven with the door open since open-door operation can result in harmful exposure to microwave energy. It is important not to defeat or tamper with the safety interlocks.
- (b) Do not place any object between the oven front face and the door or allow soil or cleaner residue to accumulate on sealing surfaces.
- (c) Do not operate the oven if it is damaged. It is particularly important that the oven door close properly and that there is no damage to the:



Important Safety Instructions

1. door (bent)
 2. hinges and latches (broken or loosened)
 3. door seals and sealing surfaces.
- (d) The oven should not be adjusted or repaired by anyone except properly qualified service personnel.

Precautions To Be Observed Before And During Servicing To Avoid Possible Exposure To Excessive Microwave Energy

- (a) Do not operate or allow the oven to be operated with the door open.
- (b) Make the following safety checks on all ovens to be serviced before activating the magnetron or other microwave source, and make repairs as necessary:
1. interlock operation
 2. proper door closing
 3. seal and sealing surfaces (arcing, wear, and other damage)
 4. damage to or loosening of hinges and latches, evidence of dropping or abuse)
- (c) Before turning on microwave power for any service test or inspection within the microwave generating compartments, check the magnetron, wave guide or transmission line, and cavity for proper alignment, integrity and connections.
- (d) Any defective or misadjusted components in the interlock, monitor, door seal, and microwave generation and transmission systems, shall be repaired, replaced, or adjusted by procedures described in this manual before the oven is released to the owner.
- (e) A microwave leakage check to verify compliance with the Federal performance standard should be performed on each oven prior to release to the owner.

Important Safety Instructions



- Clean the appliance constantly and remove any food residue.
- Do not use the microwave to dry food.
- Do not use the microwave to heat oils or fry.
- Do not use the appliance to heat foods or beverages containing alcohol.
- To avoid food overheating or burning it is very important not to select long time periods or power levels that are too high when heating small quantities of food. For example, a bread roll can burn after 3 minutes if the power selected is too high.
- For toasting, use just the broiling function and watch the oven all the time. If you use a combined function to toast bread it will catch fire in a very short time.
- Make sure you never catch the power cables of other electrical appliances in the hot door or the oven. The cable insulation may melt. **Danger of short-circuiting!**
- Baby food should not be heated in sealed containers. Remove the cover or the teat (in the case of baby bottles). Always check the preparation's temperature once heating has completed, it should not be too high. For an even temperature and to avoid scalding stir or shake the contents.
- Do not heat eggs in their shells or whole hard boiled eggs; they may explode even after the heating process has completed.
- Before cooking food with a hard skin or peel (e.g. potatoes, apples, etc.) it is necessary to puncture the skin.
- Do not heat food contained within food packages.
- Do not use the microwave functions when the oven is empty.
- Use cookware and utensils that are suitable for use in a microwave oven.
- Do not use aluminium containers to cook food.
- Do not use dishes with metallic decorations (gold-plated or silver).



Important Safety Instructions

- Warning – Microwaves! The outer protection of the oven must not be removed. It is dangerous for anyone not authorized by the manufacturer to carry out any kind of repair or maintenance work.
- Warning! The oven cannot be used if:
 1. The door is not closed correctly;
 2. The door hinges are damaged;
 3. The surfaces of the contact between the door and the oven front are damaged;
 4. The door window glass is damaged;
 5. There is frequent electrical arcing inside the oven even though there is no metal object inside.
- The oven can only be used again after it has been repaired by a Technical Assistance Service technician.
- The appliance operates in the 2.4GHz ISM band.
- In compliance with the provisions regarding electromagnetic compatibility, the appliance belongs to group 2 and class B (EN 55011).
- This appliance complies with the current standards and directives regarding safety and electromagnetic compatibility. It is however recommended for pacemaker wearers to maintain a minimum distance of 20-30cm between the microwave when it is operating and the pacemaker. Consult the pacemaker manufacturer for more information.

This device complies with Part 18 of the FCC Rules.



Important Safety Instructions



How to read the user manual

This user manual uses the following reading conventions:



Instructions

General information on this user manual, on safety and final disposal.



Description

Description of the appliance and its accessories.



Use

Information on the use of the appliance and its accessories, cooking advice.

Cleaning and maintenance



Information for proper cleaning and maintenance of the appliance.



Safety instructions



Information



Advice

1. Use instruction sequence.
 - Single use instruction.

SAVE THESE INSTRUCTIONS



Description

1 Description

1.1 General Description

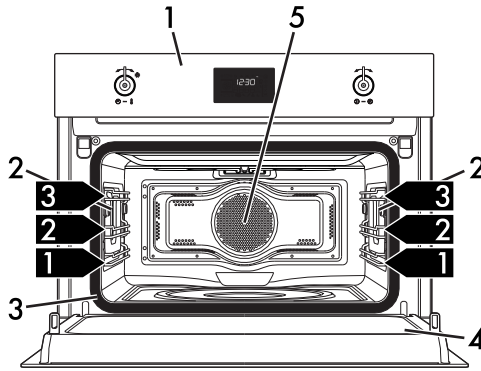

1 Control panel

2 Light bulb

3 Seal

4 Door

5 Fan

1,2,3... Frame shelf



1.2 Control panel

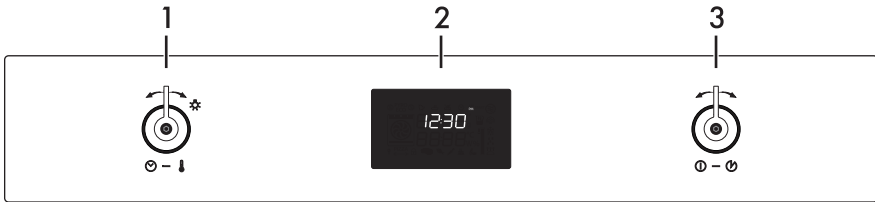

1 Temperature knob

This knob can be used to select:

- Microwave power level
- Cooking temperature
- Function duration
- Programmed cooking procedures
- The current time
- The turning on or off of the light inside the appliance.

2 Display

Displays the current time, the selected cooking temperature, power and function and any time set.

3 Function knob

This knob can be used to:

- Turn the appliance on and off
- Select a function
- Temporarily start or stop a function.



Description

1.3 Microwaves

The appliance is equipped with a microwave generator called a magnetron. The microwaves generated are evenly emitted into the oven cavity in order to reach the food and heat it.

Heating takes place through the process of friction between the molecules contained within the food (mainly water molecules), with the consequent generation of heat.

The heat generated directly inside the food allows defrosting, re-heating or cooking in a shorter length of time compared to traditional cooking.

The use of suitable containers for microwave cooking allows the microwaves to reach the food in a uniform manner (see 2.2 Materials suitable for microwaves).

1.4 Other parts

Shelves

The appliance features shelves to position trays and racks at different heights. The insertion heights are indicated from the bottom upwards (see 1.1 General Description).

Cooling fan

The fan cools the appliance and comes into operation during cooking.

The fan causes a steady outflow of air from above the door which may continue for a brief period of time even after the appliance has been turned off.

Interior lighting

The appliance's interior lighting comes on:

- when the door is opened;
- when any function is started, apart from

the ECO  and Vapor Clean  functions;

- When the temperature knob is briefly turned to the right (manual activation and deactivation)



When the door is open, it is not possible to turn off the interior lighting.



1.5 Available accessories

Boiling rod



To be placed in containers when heating liquids, necessary to avoid delayed boiling.

Rack

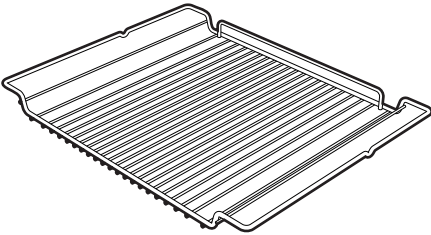

Used for supporting containers with food during cooking

Glass dish

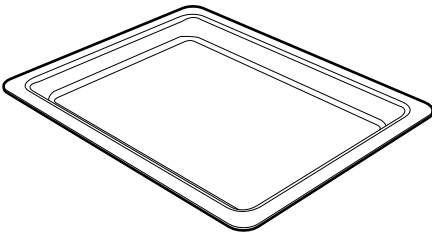

Useful for any type of cooking and collecting fat from foods placed on the rack above.

Tray rack

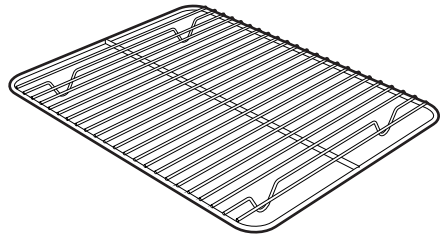

To be placed over the top of the oven tray; for cooking foods which may drip.



Not all accessories are available on some models.



The oven accessories intended to come into contact with food are made of materials that comply with the provisions of current legislation.



Original supplied and optional accessories can be requested to Authorised Assistance Centres. Use only original accessories supplied by the manufacturer.



2 Use

2.1 Instructions



High temperature inside the oven during use
Danger of burns

- Keep the oven door closed during cooking.
- Protect your hands by wearing oven gloves when moving food inside the oven.
- Do not touch the heating elements inside the oven.
- Do not pour water directly onto very hot trays.
- Do not allow children to approach the appliance when it is in operation.



Improper use
Risk of damage to enamelled surfaces

- Do not cover the bottom of the oven cavity with aluminium or tin foil sheets.
- If you wish to use greaseproof paper, place it so that it will not interfere with the hot air circulation inside the oven cavity.
- Do not bang or drag cookware over the glazed bottom of the oven cavity.
- Do not pour water directly onto very hot trays.



High temperature inside the oven during use
Danger of fire or explosion

- Do not spray any spray product near the appliance.
- Do not use or leave flammable materials near the appliance.
- Do not use plastic kitchenware for cooking food (except with the microwave function).
- Do not place sealed tins or containers in the oven cavity.
- Do not leave the appliance unattended during cooking operations where fats or oils could be released.
- Remove all trays and racks which are not required during cooking.

2.2 Materials suitable for microwaves

In general, in order for all of the food to be reached, the materials used for microwave cooking must be transparent to microwave energy.

Below is a table of materials to use and those not to use:



MATERIALS TO USE:

- Glass (always remove the lids) *

- Baking ware
- Glasses
- Cans

- Porcelain

- Ceramic

- Plastic (only where suitable for microwave use) *

- Containers
- Plastic wraps (must not come into contact with the food)

* only if heat-resistant.

MATERIALS NOT TO USE:

- Metal (can lead to arcing or sparks)

- Aluminium foil
- Aluminium trays
- Plates
- Metal utensils
- Freezer bags tie wraps

- Wood

- Crystal glasses

- Paper (risk of fire)

- Polystyrene containers (danger of contamination of foodstuffs)



Dishes must be free of metal decorations.



Do not use metal accessory trays in the microwave or combined microwave functions.

Testing dishes



The microwave function can be used without any food inside the oven only for this test.

To check whether or not cookware is suitable for use with microwave cooking carry out this simple test:

1. Remove all accessories from the oven cavity.
2. Place the crockery to be tested on the rack inserted in the first shelf.
3. Select the microwave function at maximum power level (e.g. 1000 W).
4. Set a cooking time of 30 seconds.
5. Start cooking.



Unsuitable cookware

Risk of damage to the appliance

- If there is crackling or if sparks are emitted from the cookware then immediately terminate the test. In this instance the cookware is not suitable for microwave cooking.
6. At the end of the test the cookware must be either cold or slightly warm. If the cookware is hot then it should be considered as unsuitable for microwave use.



Use

2.3 First use

1. Remove any protective film from the outside or inside of the appliance, including accessories.
2. Remove any labels (apart from the technical data plate) from the accessories and from the oven cavity.
3. Remove and wash all the appliance's accessories (see 3 Cleaning and maintenance).
4. Heat the empty oven at maximum temperature (using the traditional functions) so as to remove any manufacturing residues.



For the first reheating use a traditional function and not a microwave function.

2.4 Using the accessories

Tray rack

The tray rack has to be inserted into the tray. In this way fat can be collected separately from the food which is being cooked.

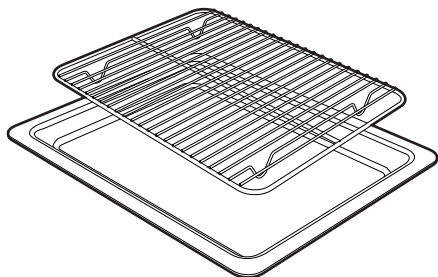

Racks and trays

Racks and trays have to be inserted into the side guides until they come to a complete stop.

- The mechanical safety locks that prevent the rack from being taken out accidentally have to face downwards and towards the oven back.

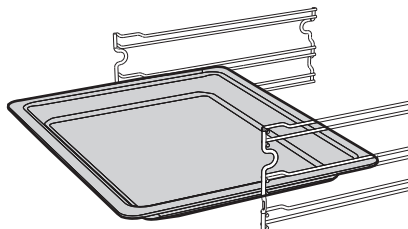
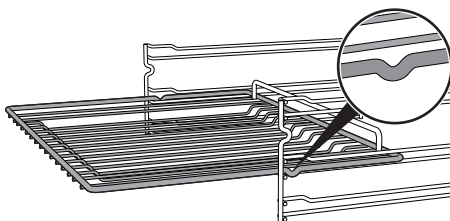

**High temperature.
Danger of burns**

- The accessory gets very hot. Always use oven gloves when handling.



Gently insert racks and trays into the oven until they come to a stop.



Clean the trays before using them for the first time to remove any residues left by the manufacturing process.



Boiling rod

When using the microwave to heat or reheat liquids, the boiling process may be delayed. To avoid this, place the boiling rod (or a heat-resistant plastic spoon) supplied into the container while heating.



Improper use.
Danger of explosion/burns

- To avoid the danger of explosion inside the appliance or the sudden boiling over of superheated liquids, it is always necessary to immerse the boiling rod in the liquid being heated.



High temperature.
Risk of damage to the accessory

- Use the boiling rod only with Microwave functions. The rod must not be used with combined and traditional functions.

2.5 Using the oven

Display

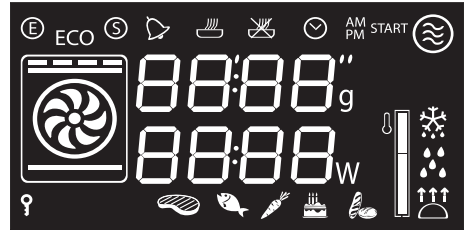

- Eco logic indicator light
- Showroom indicator light
- Minute minder timer indicator light
- Timed cooking indicator light
- Programmed cooking indicator light
- Clock indicator light
- Microwave indicator light
- Defrost indicator light
- Child lock indicator light



Temperature level reached



Use

Operating modes

Stand-by: when no function is selected, the display shows the current time.

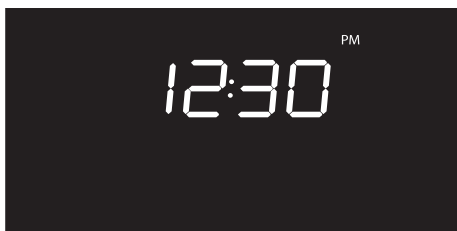

ON: When any function starts the display shows the current settings such as temperature, duration, microwave power level and the temperature level reached.

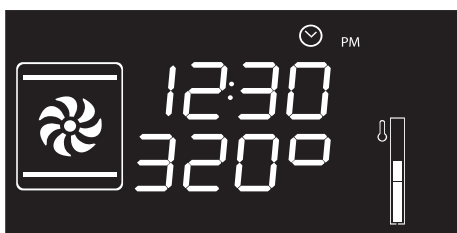

Each time the temperature knob is pressed during a function, the parameters will be cycled through in the following order.

In all modes it is possible to modify the value by turning the temperature knob to the left or right. Keep the knob turned to produce a faster increase or decrease.

If a microwave function is selected:



1. Microwave power level.
2. Function duration.

If a Microwave+Grill function is selected:



1. Temperature.
2. Function duration.
3. Microwave power level.

If a Grill function is selected:



1. Temperature
2. Minute minder timer duration.
3. Function duration.
4. Programmed cooking duration (if timed cooking has been selected).
5. Time display.



Setting the time

When using the appliance for the first time, or after a power failure, the symbol  will flash on the display. To be able to start any cooking function, the current time must be set.

1. Turn the temperature knob to set the hour displayed (to increase or a decrease more quickly keep the knob turned).
2. Press the temperature knob.
3. Turn the temperature knob to set the minutes displayed (to increase or a decrease more quickly keep the knob turned).
4. To confirm the settings press the temperature knob.



It may become necessary to change the current time, for example for daylight saving time. From the stand-by position, keep the temperature knob turned to the right or left until the hours flash. It is not possible to change the time if the oven is **ON**.

Microwaves



Improper use

Risk of damage to the appliance

While using microwaves, the food must be placed in a suitable container resting on the rack inserted in the first runner.

DO NOT USE CONTAINERS/ACCESSORIES (trays, glass trays, etc.) RESTING DIRECTLY ON THE BOTTOM OF THE OVEN CAVITY.

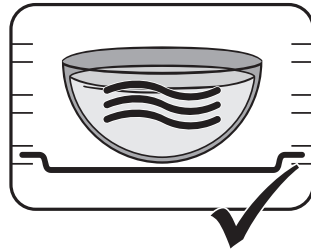
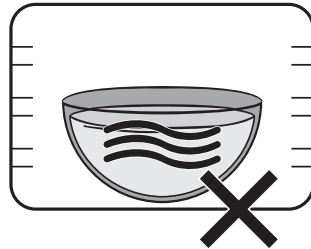

For perfect results with long microwave and combined cooking functions, food should be stirred once or twice during cooking.



Use



Microwaves

Given that they penetrate directly into the food, microwaves allow cooking to take place in a very short period of time and with a considerable saving of energy. They are suitable for cooking without fat and also for defrosting and re-heating food while maintaining its original appearance and fragrance.

1. Select the microwave function  using the function knob.

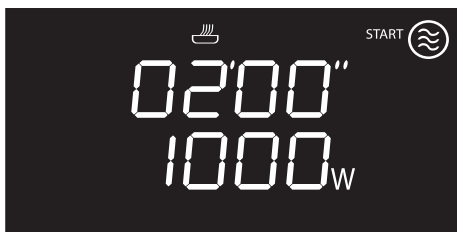

2. Press the temperature knob.
3. Turn the temperature knob to change the cooking time (max 30 minutes).
4. Press the temperature knob.
5. Turn the temperature knob to change the power level from 100 W to 1000 W (see Microwave power levels).

6. Press the function knob to start microwave cooking.



If the door is opened then cooking will stop. Once the door is closed press the function knob to resume cooking.



Press the function knob to temporarily stop the cooking function. Press it again to resume cooking.

7. At the end of cooking, **STOP** is shown on the display and a buzzer sounds.





8. To deactivate the buzzer, press or turn one of the two knobs or open the door.



To deactivate the buzzer and select a further timed cooking, turn the temperature knob to the right.



To deactivate the buzzer and select a different cooking function, turn the function knob to the right or left.



Press and hold the function knob down to switch off the appliance.

Microwave power levels

Below is a list of the power levels that can be selected:

Power (W)	Useful for
100	Defrosting food
200	
300	
400	Cooking meat or delicate cooking
500	
600	Re-heating and cooking food
700	
800	
900	Heating liquids
1000	

QUICK START microwave function



The QUICK START function allows the microwave to be started quickly. This is useful for heating small quantities of liquid or food.

1. From stand-by mode press the function knob twice.



2. The appliance will start the microwave oven with the default settings.

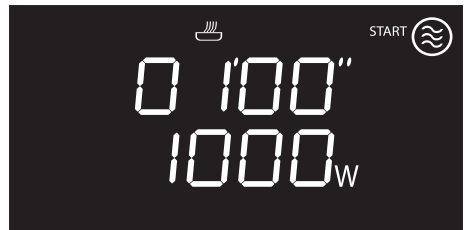



Use

Combined functions



**Improper use.
Risk of damage to the appliance**

- Do not use the combined functions to heat or boil liquids.



Combined cooking is a mix of traditional cooking and microwave operation. These functions are indicated by the switching on of a traditional function symbol together with the microwave function indicator light .

1. Turn the control knob to select a combined function.



2. Press the temperature knob.
3. Turn the knob to set the temperature.
4. Press the temperature knob.
5. Turn the temperature knob to change the cooking time.
6. Press the temperature knob.
7. Turn the temperature knob to change the power level (from 100 W to 700 W).
8. Press the function knob to start combined cooking.

Preheating stage

Cooking itself is preceded by a preheating stage, which allows the appliance to heat to the cooking temperature more quickly.

The temperature level reached indication flashes to indicate that this stage is in progress.



When the preheating stage is complete, temperature level reached indication will remain lit steadily and a buzzer sounds to indicate that the food can be placed inside the oven.



With the combined Microwave+Grill function, given the type of cooking and in order to cook more quickly preheating is not performed.



Cooking can be interrupted at any time by pressing and holding the function knob down for at least 3 seconds.



Combined functions list



Microwave + Grill

The use of the grill results in perfect browning of the food's surface.



Using the microwave on the other hand leads to rapid internal cooking of the food.



Microwave + static + fan

The operation of the fan, combined with traditional cooking, ensures consistent cooking even with complex recipes. Using the microwave on the other hand leads to rapid internal cooking of the food.



Microwave + Circulaire + Fan

For combined cooking of food in a short time thanks to the microwave action working together with hot air circulation.



Traditional cooking functions

1. Select a cooking function with the function knob.

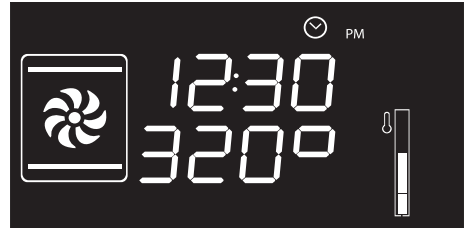

2. Press and turn the temperature knob to modify the cooking temperature.
3. Press the function knob to start traditional cooking.



A function can be interrupted at any time by pressing and holding the function knob for at least 3 seconds.

Preheating stage

Cooking itself is preceded by a preheating stage, which allows the appliance to heat to the cooking temperature more quickly.

The temperature level reached indication flashes to indicate that this stage is in progress.



When the preheating stage is complete, temperature level reached indication will remain lit steadily and a buzzer sounds to indicate that the food can be placed inside the oven.





Traditional functions list



ECO

This function is particularly suitable for cooking on a single shelf with low energy consumption.

Ideal for cooking meat, fish and vegetables. It is not recommended for leavened foods.

To obtain maximum energy savings and reduce cooking times, it is recommended to place food in the oven without preheating.



When using the ECO function, avoid opening the door during cooking.



Cooking (and preheating) times are longer with the ECO function.



Static

As the heat comes from above and below at the same time, this system is particularly suitable for certain types of food. Traditional cooking, also known as static cooking, is suitable for cooking just one dish at a time. Perfect for all types of roasts, bread and cakes, and in any case, particularly suitable for fatty meats such as goose and duck.



Grill

The heat coming from the grill element gives perfect grilling results above all for thin and medium thickness meat and, in combination with the rotisserie (where fitted), gives the food an even browning at the end of cooking. Perfect for sausages, spare ribs and bacon. This function enables large quantities of food, particularly meat, to be grilled evenly.



Fan assisted

The operation of the fan, combined with traditional cooking, ensures consistent cooking even with complex recipes. Perfect for biscuits and cakes, even when simultaneously cooked on several levels. (For multiple-level cooking, we recommend using the 2nd and 4th shelf).



Fan-assisted grill

The air produced by the fan softens the strong heatwave generated by the grill, grilling perfectly even very thick foods. Perfect for large cuts of meat (e.g. shin of pork).



Fan + lower element

The combination of the fan with just the lower heating element allows cooking to be completed more rapidly. This system is recommended for sterilising or for finishing off the cooking of foods which are already well-cooked on the surface, but not inside, which therefore need a little more heat. Perfect for any type of food.



Round

The combination of the fan and the circulaire heating element (incorporated in the rear of the oven) allows you to cook different foods on several levels, as long as they need the same temperature and type of cooking. Hot air circulation ensures instant and even distribution of heat. It will be possible, for instance, to cook fish, vegetables and biscuits simultaneously (on different levels) without odours and flavours mingling..



Turbo

The combination of fan assisted cooking and traditional cooking allows different foods to be cooked on several levels extremely quickly and efficiently, without odours and flavours mingling. Perfect for large volumes that call for intense cooking.

Timer





This function only activates the buzzer, without stopping cooking.

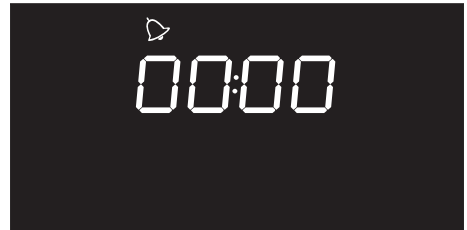

The minute minder can be activated both during cooking and when the appliance is in standby.

1. Press the temperature knob once (twice if cooking is already in progress). The display shows **00:00** and the indicator light  flashes.



2. Turn the knob to set the duration (from 1 minute to 4 hours). After a few seconds, the indicator light  stops flashing and the countdown starts.
3. Select the required cooking function and wait for the buzzer to sound, indicating that the cooking time is over. The indicator light  flashes.



Use

- To deactivate the buzzer, press or turn one of the two knobs.
- To select a further minute minder, turn the temperature knob.



You must set the value to zero to remove the minute minder timer.

Timed cooking



Timed cooking is the function which allows a cooking operation to be started and then ended after a specific length of time set by the user.



Activation of timed cooking cancels any minute minder timer which may previously have been set.

- After selecting a cooking function and temperature, press the temperature knob three times. The display shows

00:00 and the indicator light  flashes.

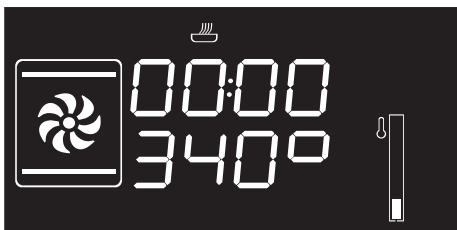

- Turn the temperature knob right or left to set the cooking duration from 00:01 to 12:59. Keep the knob turned to produce a faster increase or decrease.

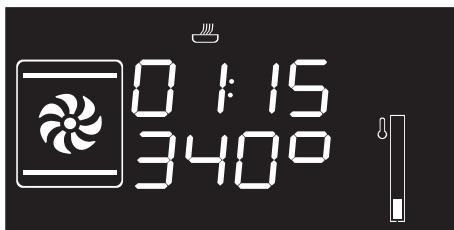

- A few seconds after the required duration is set, the indicator light  stops flashing and timed cooking starts.



To extend the cooking time manually, press the temperature knob again. The appliance will resume its normal operation with the previously selected cooking settings.

- At the end of cooking, **StoP** is shown on the display and a buzzer sounds.



- To deactivate the buzzer, press or turn one of the two knobs or open the door.



To deactivate the buzzer and select a further timed cooking, turn the temperature knob to the right.





To deactivate the buzzer and select a different cooking function, turn the function knob to the right or left.



Press and hold the function knob down to switch off the appliance.

Modifying the data set during timed cooking

During operation, it is possible to modify timed cooking duration:

1. When the indicator light  is steady and cooking is in progress inside the appliance, press the temperature knob twice. The indicator light  starts flashing.
2. Turn the temperature knob right or left to alter the pre-set cooking time.

Programmed cooking



Programmed cooking is the function which allows cooking to be stopped at an established time depending on the time set by the user, after which the appliance will switch off automatically.

1. After selecting a cooking function and temperature, press the temperature knob three times. The display shows



and the indicator light  flashes.

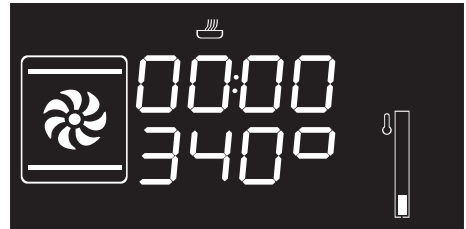

2. Turn the knob right or left to set the cooking duration from 00:01 to 12:59. Keep the knob turned for a fast increase or decrease.







Use

3. Press the temperature knob a fourth time.

The indicator light  flashes. Turn the knob right or left to set the cooking end time.

4. After a few seconds the indicator lights

 and  stop flashing. The appliance waits for the set start time.

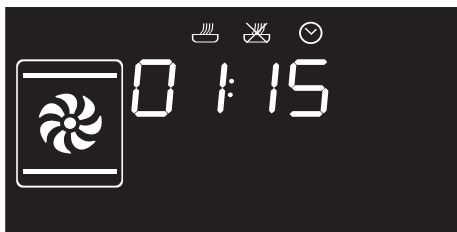

To extend the cooking time manually, press the temperature knob again. The appliance will resume its normal operation with the previously selected cooking settings.



With programmed cooking, the oven is switched on ten minutes beforehand to allow the appliance to reach cooking temperature (preheating).

5. At the end of cooking, **STOP** is shown on the display and a buzzer sounds.

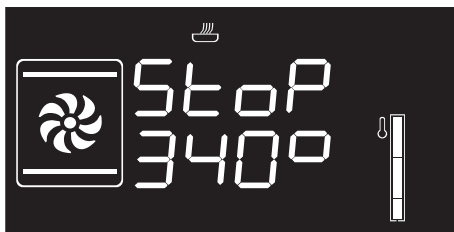

6. To deactivate the buzzer, press or turn one of the two knobs or open the door.



Press and hold the function knob down to switch off the appliance.



For safety reasons, it is not possible to set the end of cooking time by itself without setting the cooking duration.







Modifying the data set during programmed cooking



After modifying the cooking duration, the end of cooking time must be re-set.

During operation, it is possible to modify programmed cooking duration:



1. When the indicator lights  and  are lit steadily and the appliance is waiting for cooking to start, press the temperature knob twice. The indicator light  starts flashing.
2. Turn the temperature knob right or left to alter the pre-set cooking time.
3. Press the temperature knob again. The indicator light  switches off and the indicator light  starts flashing. The display shows the cooking end time.
4. Turn the temperature knob right or left to delay the cooking end time.
5. After a few seconds the indicator lights  and  stop flashing and programmed cooking resumes its operation with the new settings.

Traditional cooking tips

General advice

- Use a fan assisted function to achieve consistent cooking at several levels.
- It is not possible to shorten cooking times by increasing the temperature (the food could be overcooked on the outside and undercooked on the inside).

Advice for cooking meat

- Cooking times vary according to the thickness and quality of the food and to consumer taste.
- Use a meat thermometer when roasting meat, or simply press on the roast with a spoon. If it is hard, it is ready; If not, it needs another few minutes cooking.

Advice for cooking with the Grill and the Fan with grill

- Meat can be grilled even when it is put into the cold oven or into the preheated oven if you wish to change the effect of the cooking.
- With the Fan with grill function, we recommend that you preheat the oven before grilling.
- We recommend placing the food at the centre of the rack.



Advice for cooking desserts/pastries and biscuits

- Use dark metal moulds: They help to absorb the heat better.
- The temperature and the cooking time depend on the quality and consistency of the dough.
- To check whether the dessert is cooked right through: At the end of the cooking time, put a toothpick into the highest point of the dessert. If the dough does not stick to the toothpick, the dessert is cooked.
- If the dessert collapses when it comes out of the oven, on the next occasion reduce the set temperature by about 50°F, selecting a longer cooking time if necessary.

To save energy

- Stop cooking a few minutes before the time normally used. Cooking will continue for the remaining minutes with the heat which has accumulated inside the oven.
- Reduce any opening of the door to a minimum to avoid heat dispersal.
- Keep the inside of the appliance clean at all times.

2.6 Special functions

Proving

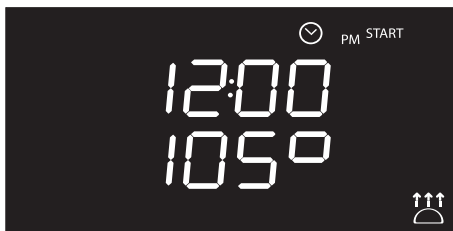

When using the proving function the temperature cannot be altered.



For successful proving, a container of water should be placed in the bottom of the oven.

1. Position the dough for proving on the second shelf.
2. Press and turn the function knob to select the proving function  **START** flashes.
3. Press the function knob to start the proving function.
4. At the end, **STOP** is displayed and a buzzer sounds.



- To deactivate the buzzer, press or turn one of the two knobs or open the door.
- Press and hold the function knob for at least 3 seconds to exit the function.

Heating



This function is for microwave re-heating of food that has been previously cooked and stored in the refrigerator.

- Press the function knob to select the re-heating function.

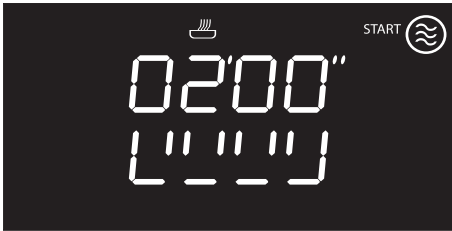

- Press the temperature knob.
- Turn the temperature knob to modify the heating duration.
- Press the function knob to confirm the settings and start re-heating.

Sabbath mode



This function allows food to be cooked in accordance with the provisions of the Jewish religion day of rest.



This function results in the appliance operating in a particular way:

- Cooking can proceed indefinitely, it is not possible to set any time.
- No preheating will be performed.
- The cooking temperature which can be selected varies between 140-210 °F.
- Oven light disabled, any operation such as opening the door or manual activation with the knob will not activate the light.
- The internal fan remains turned off.
- Knob illumination and audible prompts remain disabled.



Use



After activating the Sabbath mode the settings cannot be altered.



Any action on the knobs will produce no effect; only the function knob remains active to allow the appliance to be turned off.

1. Press and turn the function knob to select the Sabbath function **SAbb**.
2. Press and turn the temperature knob to modify the temperature of the function.
3. Press the temperature knob to confirm the set temperature. **START** flashes.
4. Press the function knob to start the Sabbath function.
5. Press and hold the function knob for at least 3 seconds to exit the function.

Defrost by time



This function allows food to be defrosted by the microwave according to a selected period of time.

1. Place the food inside the oven cavity (see "Turn" procedure).
2. Use the function knob to select timed defrosting as indicated by the  and  symbols.

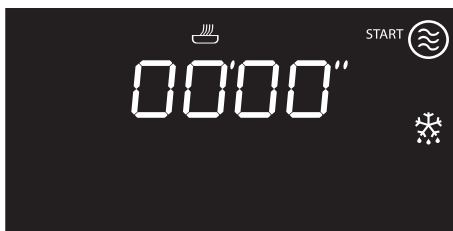

3. Press the temperature knob to change the defrosting time.
4. Turn the knob to adjust the value (from 5 seconds to 99 minutes).
5. Press the function knob to start defrosting.



If the selected defrost duration is more than 5 minutes then, for best results, the dish inside the oven compartment will need to be turned. See: "Turn" procedure.

6. At the end, the word **StoP** will be displayed flashing.



Defrost by weight

i This function defrosts foods on the basis of the type and weight of the frozen products.

1. Place the food inside the oven cavity (see "Turn" procedure).
2. Press and turn the function knob to select defrost by weight, marked by **dE00** and the illuminated food symbols .







3. Press the function knob to confirm the defrost by weight function.
4. Turn the function knob to select the type of food to defrost.
5. Turn the temperature knob to select the weight (in grams) of the food to defrost.
6. Press the function knob to confirm the parameters and start defrosting.

 For best results during defrosting the dish inside the oven will need to be turned. See: "Turn" procedure.

7. At the end, **STOP** is displayed and a buzzer sounds.
8. To deactivate the buzzer, press or turn one of the two knobs or open the door.
9. Press and hold the function knob for at least 3 seconds to exit the function.

Pre-set parameters

dE	Type	Weight (oz/kg)	Time (min)*
01	 Meat	20/0,5	20
02	 Fish	16/0,4	17
03	 Fruit	12/0,3	15
04	 Bread	12/0,3	5

*Defrosting times may vary on the basis of the shape and size of the food to be defrosted.



"Turn" procedure

For best defrosting results it is recommended, when necessary, to turn the dish inside the oven cavity.

1. Put the dish in the oven, placing it parallel to the door.

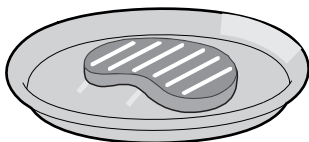

2. When **turn** is displayed it is necessary to turn the dish.

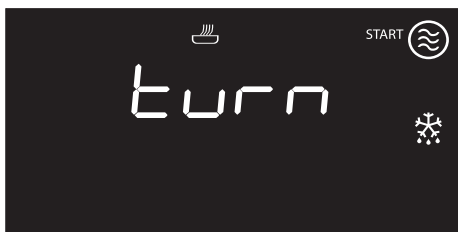

3. Open the door and turn the dish 90°.

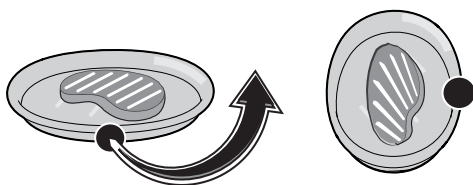

i If dish rotation is not performed the appliance will wait for one minute and then automatically continue defrosting. As a reminder the word **turn** will remain displayed beneath the countdown indication.



4. Close the door and press the function knob to resume operation.
5. If necessary the appliance will again ask for rotation of the dish. **turn** will be shown on the display.
6. For the second rotation the door will need to be opened and the dish turned by 180°.

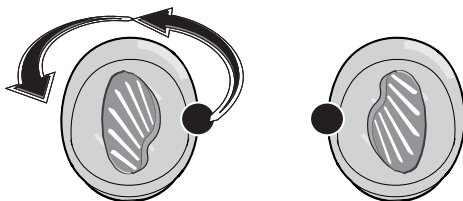

7. Close the door and press the function knob to resume operation.



2.7 Automatic programs

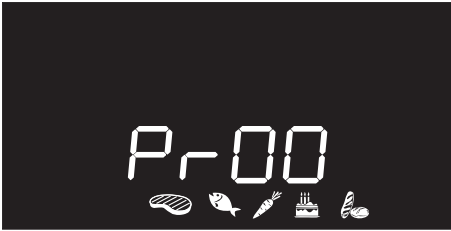

The automatic cooking programs are divided up according to the type of dish to be cooked.

1. Press and turn the function knob to select cooking with automatic programs, marked by **Pr-00** and the illuminated food symbols .
2. Press the function knob to confirm cooking with automatic programs.
3. Turn the function knob to select the preferred program (see Automatic programs table).
4. Turn the temperature knob to select the weight (in grams) of the food to cook.

5. When preheating has finished,

START will flash. Introduce the food and then press the function knob to start cooking.

6. At the end, **Stop** is displayed and a buzzer sounds.
7. To deactivate the buzzer, press or turn one of the two knobs or open the door.
8. Press and hold the function knob for at least 3 seconds to exit the function.



It is possible to set programmed cooking in automatic programs.



A function can be interrupted at any time by pressing and holding the function knob for at least 3 seconds.



Use

Automatic programs table



MEAT (01 - 05)

Pr	Subcategory	Weight (oz/kg)	Level	Function	MW (W)	Temp. (°F/°C)	Time (minutes)
01	Roast beef (medium)	36/1,0	1		-	395/200	60
02	Roast pork	36/1,0	1		300	375/190	60
03	Lamb (well cooked)	42/1,2	1		300	375/190	60
04	Roast veal	36/1,0	1		300	375/190	70
05	Whole roast chicken	36/1,0	1		300	395/200	50



FISH (06 - 07)

Pr	Subcategory	Weight (oz/kg)	Level	Function	MW (W)	Temp. (°F/°C)	Time (minutes)
06	Fresh (whole)	20/0,5	1		300	320/160	30
07	Frozen	20/0,5	1		300	320/160	40



VEGETABLES (08 - 10)

Pr	Subcategory	Weight (oz/kg)	Level	Function	MW (W)	Temp. (°F/°C)	Time (minutes)
08	Mixed grilled	20/0,5	3		-	480/250	15 + 10 ⁽¹⁾
09	Roast	36/1,0	2		-	395/200	45
10	Frozen French fries	20/0,5	2		-	430/220	13

⁽¹⁾ When grilling, it is recommended to cook foods on both sides, making reference to the times given in the table. The greater time always refers to the first side to be cooked, starting with raw foodstuffs.



DESSERTS/PASTRIES (11 - 13)

EN

Pr	Subcategory	Weight (oz/kg)	Level	Function	MW (W)	Temp. (°F/°C)	Time (minutes)
11	Biscuits	24/0,6	1		-	320/160	18
12	Tart	28/0,8	1		-	340/170	40



BREAD - PIZZA - PASTA (14-20)

Pr	Subcategory	Weight (oz/kg)	Level	Function	MW (W)	Temp. (°F/°C)	Time (minutes)
13	Leavened bread (loaf)	36/1,0	1		-	395/200	30
15	Pan baked pizza	36/1,0	1		-	480/250	9
15	Frozen pizza	12/0,3	1		-	480/250	8
16	Pasta bake	70/2,0	1		-	430/220	40
17	Lasagna (freshly-made)	70/2,0	1		-	450/230	35
18	Lasagna (frozen)	12/0,3	1		500	450/230	9
19	Quiche Lorraine	36/1,0	1		-	395/200	40
20	Soufflé	20/0,5	1		-	360/180	25

⁽²⁾ (Models without Pizza stone) The stone must be positioned on the base of the oven cavity. Frozen pizza cooked on the stone does not require different cooking times depending on weight.



The times indicated in the tables do not include preheating times and refer to cooking whole pieces. If the foodstuffs are cut into smaller portions, the cooking times will decrease.



2.8 Secondary menu

The appliance also has a drop-down secondary menu allowing the user to:

- Activate or deactivate the Child lock.
- Activate or deactivate Showroom mode (which disables all the heating elements so that only the control panel works).
- Activate or deactivate Low Power (Eco-Logic) mode.
- Activate or deactivate Light timing (Eco-light) mode.

With the appliance in Stand-by status

1. Activate the internal light by turning the temperature knob quickly.
2. Press and hold the temperature knob down for at least 5 seconds.
3. Turn the temperature knob right or left to change the setting status (**ON/OFF**).
4. Press the temperature knob to move to the next mode.

Child lock mode

This mode allows the appliance to lock the controls automatically after one minute of normal operation without any intervention from the user.

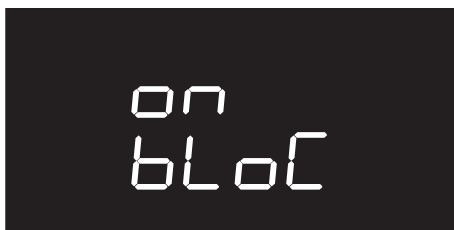
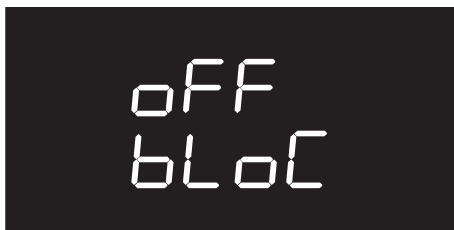

During normal operation it is indicated by the indicator light  coming on.

To release the lock temporarily during cooking, hold the temperature knob down for 5 seconds. One minute after the last setting the lock will become active again.



When the position of the knobs is changed, the display will show

bLoC for a few seconds.



It is still possible to turn the appliance off instantaneously by pressing and holding the function knob down for 3 seconds when in child lock mode.



Showroom mode (for exhibitors only)

This mode allows the appliance to deactivate all heating elements, while keeping the control panel active.



To use the appliance normally, set this mode to OFF.



If the mode is active, the indicator light  lights up on the display.

Low power mode

This mode allows the appliance to limit the power used.

Suitable for simultaneous use with further home appliances.

HI: normal power.



LO: low power.

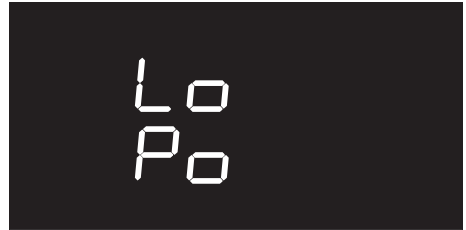

Activating Eco-logic mode means that preheating and cooking times may be extended.



If the mode is active, the indicator light  lights up on the display.



Use

Keep Warm Mode (some models only)

In this mode, at the conclusion of the cooking cycle for which a duration was set (if not stopped manually), the appliance keeps freshly cooked food warm (at low temperatures) for around 1 hour.

off
Hold

on
Hold

Internal lamp timed mode

For greater energy savings, the light is automatically deactivated one minute from the start of cooking.

on
LIGHT

To stop the appliance from automatically deactivating the light after one minute, set this mode to OFF.

off
LIGHT



The manual off/on control is always available with both settings by turning the temperature knob to the right.



3 Cleaning and maintenance

3.1 Instructions



High temperature inside the oven after use
Danger of burns

- Perform cleaning only after letting the appliance cool down.



Improper use
Risk of damage to surfaces

- Do not use steam jets to clean the appliance.
- Do not use cleaning products containing chlorine, ammonia or bleach on parts made of steel or that have metallic surface finishes (e.g. anodizing, nickel- or chromium-plating).
- Do not use abrasive or corrosive detergents (e.g. scouring powders, stain removers and metallic sponges) on glass parts.
- Do not use rough or abrasive materials or sharp metal scrapers.
- Failure to clean the oven could adversely affect the life of the appliance and pose a hazard.
- Always remove food residues from the oven cavity.



Improper use.
Danger of explosion/burns

- Do not use detergents with high alcohol content or which can release inflammable vapours. Subsequent heating could set off an explosion inside the appliance.



If a lamp is damaged, contact Technical support for a replacement. This fault will not affect the integrity of the appliance which can continue to be used.

3.2 Cleaning the surfaces

To keep the surfaces in good condition, they should be cleaned regularly after use. Let them cool first.

Ordinary daily cleaning

Always and only use specific products that do not contain abrasives or chlorine-based acids.

Pour the product onto a damp cloth and wipe the surface, rinse thoroughly and dry with a soft cloth or a microfibre cloth.



Cleaning and Maintenance

Food stains or residues

Do not use steel sponges and sharp scrapers as they will damage the surface.

Use normal, non-abrasive products and a wooden or plastic tool, if necessary. Rinse thoroughly and dry with a soft cloth or a microfibre cloth.

Do not allow residues of sugary foods (such as jam) to set inside the oven. If left to set for too long, they might damage the enamel lining of the oven.

3.3 Cleaning the door glazing

The glass in the door should always be kept thoroughly clean. Use absorbent kitchen roll. In case of stubborn dirt, wash with a damp sponge and an ordinary detergent.



We recommend the use of cleaning products distributed by the manufacturer.

3.4 Cleaning the oven cavity

In order to keep your oven in the best possible condition, clean it regularly after letting it cool down.

Avoid letting food residue dry inside the oven cavity, as this could damage the enamel.

Take out all removable parts before cleaning.

For easier cleaning, it is recommended to remove the racks/trays support frames.



In the event you are using specific cleaning products, we recommend running the oven at maximum temperature for 15-20 minutes in order to eliminate any residue.

Drying

Cooking food generates moisture inside the appliance. This is a normal phenomenon and does not affect the appliance's operation in any way.

Each time you finish cooking:

1. Let the appliance cool down.
2. Remove any dirt from inside the appliance.
3. Dry the interior of the appliance with a soft cloth.
4. Leave the door open until the inside of the appliance has dried completely.



Removing racks/trays support frames

Removing the guide frames enables the sides to be cleaned more easily.

To remove the guide frames:

1. Unscrew the frame fastening pins:

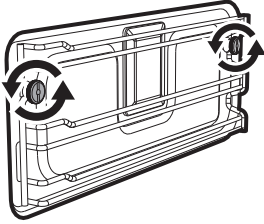

2. Pull the frame towards the inside of the oven to free it from the fastening pins.

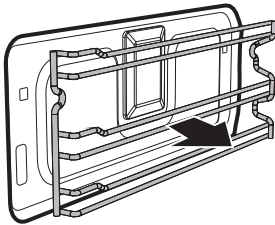

3. When cleaning is complete, repeat the above procedures to put the guide frames back in. Pay attention to the spacer bushings which need to be inserted correctly into the frames.

Cleaning the top section



High temperature inside the oven during use
Danger of burns

- The following operations must be carried out only with the oven completely cold and turned off.

The appliance is equipped with a tilting grill element that allows for easy cleaning of the upper part of the oven cavity.

1. Free the upper heating element by gently lifting it and rotating its retaining latch by 90 degrees.

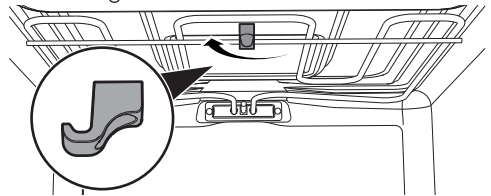

2. Gently lower the heating element until it stops.

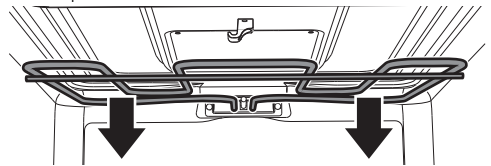

Improper use
Risk of damage to the appliance

- Do not excessively flex the element during cleaning.

3. When you have finished cleaning, place the heating element back in position and turn the retaining latch to lock it in place.



Cleaning and Maintenance

3.5 Vapor Clean



Vapor Clean is an assisted cleaning procedure which facilitates the removal of dirt. Thanks to this process, it is possible to clean the inside of the oven very easily. The dirt residues are softened by the heat and water vapour for easier removal afterwards.



Improper use Risk of damage to surfaces

- Remove any large amounts of food residues or spills from previous cooking operations from the inside of the oven.
- Carry out assisted oven cleaning operations only when the oven is cold.

Preliminary operations

Before starting the Vapor Clean function:

- Completely remove all accessories from inside the oven. The upper guard can be left inside the oven.

- Pour approx. 40 cc of water onto the bottom of the oven. Make sure it does not overflow out of the cavity.

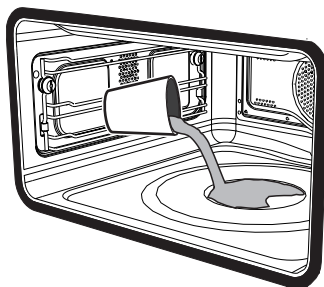

- Spray a water and washing up liquid solution inside the oven using a spray nozzle. Direct the spray against the side walls, upwards, downwards and towards the deflector.

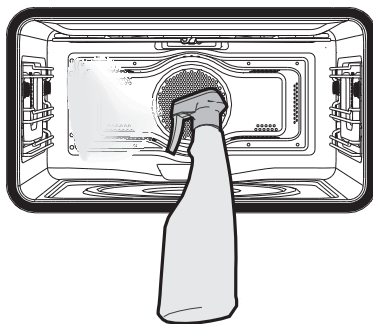

We recommend spraying approx. 20 times at the most.

- Close the door.



Vapor Clean cycle setting

i If the internal temperature is greater than that required for the Vapor Clean cycle, the cycle will be stopped immediately and the message **StoP** will appear on the display. Let the appliance cool down before activating the assisted cleaning cycle.

1. Press and turn the function knob to select the Vapor Clean function . The duration and temperature of the cleaning cycle will appear on the display.

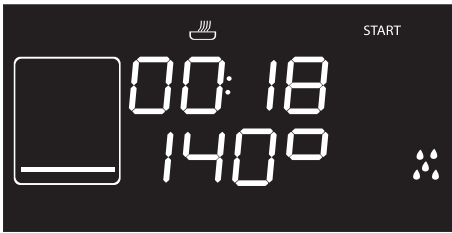

i The temperature and time parameters cannot be modified by the user.

2. Press the function knob to start the automatic cleaning cycle.

Programmed Vapor Clean cycle

Like for the normal cooking functions, it is also possible to set an end time for the Vapor Clean function.

1. After selecting the Vapor Clean function, press the temperature knob. The indicator light  starts flashing. The display shows the function end time.

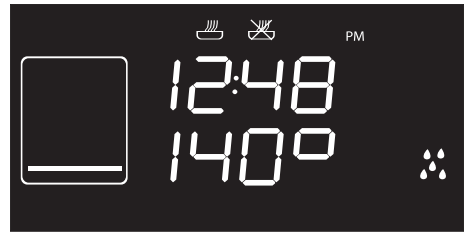

2. Turn the temperature knob right or left to delay the cooking end time.
3. Press the temperature knob to confirm the function end time.
4. Press the function knob. The appliance waits for the set start time.

End of the Vapor Clean cycle

At the end **StoP** appears on the display and a buzzer will sound that can be deactivated by pressing the temperature knob.

1. Press and hold the function knob for at least 3 seconds to exit the function.
2. Open the door and wipe away the less stubborn dirt with a microfibre cloth.



Cleaning and Maintenance

3. Use an anti-scratch sponge with brass filaments on tougher encrustations.
4. In case of grease residues use specific oven cleaning products.
5. Remove the residual water inside the oven.

For greater hygiene and to avoid food being affected by any unpleasant odours, we recommend that the oven is dried using a fan-assisted function at 320°F for approximately 10 minutes.



We recommend wearing rubber gloves for these operations.



For easier manual cleaning of parts that are difficult to reach, we recommend removing the door.

What to do if...

The display is completely off:

- Check the mains power supply.
- Check whether an all-pole disconnection switch upstream of the appliance supply line is in the "ON" position.

The appliance does not heat up:

- Check whether the "showroom" mode has been set (for further details see 2.8 Secondary menu).

The controls do not respond:

- Check whether the "child lock" mode has been set (for further details see "Secondary menu").

The cooking times are longer than those indicated in the table:

Check whether it has been set in "ecologic" mode (for further details see "Secondary menu").

If the door is opened during a fan assisted function, the fan stops:

- This is not a fault. It is a normal operation of the appliance, useful when cooking foods in order to avoid excessive heat escaping. When the door is closed, the oven will return to normal operation.



If the problem has not been resolved or in the case of other types of fault, contact your local technical support centre.



If other ERRx error messages are indicated:

Note down the error message, function and set temperature and contact your local technical support centre.