

# Table of Contents

<b>1 Description</b>	<b>8</b>
1.1 General Description	8
1.2 Control panel	8
1.3 Other parts	9
1.4 Available accessories	10
<b>2 Use</b>	<b>11</b>
2.1 First use	11
2.2 Use of accessories	12
2.3 Using the oven	12
2.4 Programming clock	15
<b>3 Cleaning and maintenance</b>	<b>21</b>
3.1 Surface cleaning	21
3.2 Cleaning the door	22
3.3 Cleaning inside the oven	24
3.4 Vapor Clean	25
3.5 Extraordinary maintenance	27

## IMPORTANT SAFETY INSTRUCTIONS

**WARNING:** If the instructions contained in this manual are not followed precisely, fire or explosion may result causing property damage, personal injury or loss of life.



**READ AND SAVE THESE INSTRUCTIONS** - Your safety and the safety of others are very important.

We have provided many important safety messages throughout this manual and on the appliance.

Read all the instructions before using the appliance and always obey all safety messages.



## Important Safety Instructions



### RECOGNIZE SAFETY INFORMATION

This is a safety alert symbol. This symbol alerts you to potential hazards that can result in severe personal injury or loss of life.

### UNDERSTAND SIGNAL WORDS

A signal word - DANGER, WARNING or CAUTION - is used with the safety alert symbol. DANGER denotes the most serious hazards. It means you could lose your life or be seriously injured if you do not immediately follow the instructions. WARNING means you could lose your life or be seriously injured if the instructions are not followed. CAUTION indicates a potentially hazardous situation which, if not avoided, could result in minor to moderate injury.

#### WARNING



- This appliance is intended for use in the home only.
- Use this appliance only for its intended purpose. The manufacturer cannot be held liable for damage caused by improper use of this appliance.
- This appliance complies with current safety regulations. Improper use of this appliance can result in personal injury and material damage.
- Read all the instructions before installing or using the appliance for the first time.
- Keep these operating instructions in a safe place and pass them on to any future user.

The safety messages will inform you of potential hazards, how to avoid the risk of injury and what can occur if the instructions are not followed.

**IMPORTANT: Observe all codes and ordinances in force.**

**WARNING: For your safety, the instructions contained in this manual must be followed to minimize the risk of fire or explosion and to prevent property damage, personal injury or loss of life.**

Do not store or use gasoline or other flammable vapors, liquids or materials near this or any other appliance.



**NOTE:** This appliance is NOT designed for installation in manufactured (mobile) homes or in recreational vehicles (RVs).

**DO NOT install this appliance outdoors.**

# Important Safety Instructions



## WARNING



To reduce the risk of fire, electrical shock, personal injury, or damage when using the appliance, follow basic safety precautions, including the following:

- Read all instructions.
- Proper installation is your responsibility. Have a qualified technician install and ground this appliance in accordance with these installation instructions.
- It is the responsibility of the installer to comply with installation information specified on the model/serial ID plate. The ID plates are visibly located on the back of the appliance and on the oven door frame. These ID plates must never be removed.
- Proper installation is your responsibility. Make sure your appliance is properly installed and grounded by a qualified installer.
- **WARNING: NEVER** use this appliance as a space heater to heat or warm the room. Doing so may result in overheating of the oven.
- **DO NOT LEAVE CHILDREN UNATTENDED:** Children should not be left alone or unattended in the area where the appliance is being used. Never allow children to sit or stand on any part of the appliance.
- **CAUTION:** Do not store items of interest to children in cabinets above a range or on the backguard of a range - children climbing on the range to reach items could be seriously injured.
- **WEAR PROPER APPAREL:** Loose-fitting or hanging garments should never be worn while using the appliance.
- For safety reasons and to avoid damage to your appliance, never sit, stand or lean on the oven door.
- **FLAMMABLE MATERIALS SHOULD NEVER BE STORED IN THE OVEN.**
- **DO NOT TOUCH THE INSIDE OF THE APPLIANCE:** Heating elements may be hot even though they are dark in color. The oven cavity can be hot enough to cause burns. During and after use, do not touch areas inside of the oven until they have had sufficient time to cool. Do not allow garments or any flammable material to come into contact with hot surfaces. If personal clothing or hair catches on fire, drop and roll immediately to extinguish the flames.
- **PLACE THE OVEN RACKS IN THE DESIRED POSITION WHILE THE OVEN IS COOL:** If a rack must be removed while the oven is hot, do not allow the potholders to come in contact with the broiler burner.
- **USE CAUTION WHEN OPENING THE OVEN DOOR:** Allow hot air or steam to escape before removing or placing foods in the oven.
- Do not leave the packing materials around the home. Sort the various items of waste and take them to the nearest specialized waste collection facility.
- Do not obstruct oven vents or openings for air intake.



## Important Safety Instructions

- **ELECTRICAL GROUNDING IS REQUIRED.** It is the customer's responsibility:
  1. To contact a qualified electrician.
  2. To ensure that the electrical system is adequate and in compliance with the National Electrical Code ANSI / NFPA 70 Electrical Code – latest edition – or the CANADIAN ELECTRICAL CODE, C22.11 – 1982 and C22.2 No. 01982 – or latest edition – and all local codes and ordinances.
- Always check that the controls are in the "zero" (off) position when the oven is not in use.
- Do not attempt to repair or replace any part of this appliance unless specifically recommended in this manual. All other servicing should be done by a qualified technician.
- Never use any part of the oven for storage. Flammable materials can ignite and plastic items may melt or burst into flame.
- Do not hang articles on any part of the appliance or place anything against the oven. Some fabrics are extremely flammable and could ignite.
- **DO NOT USE ALUMINUM FOIL TO LINE ANY PART OF THE OVEN.** Use of a foil liner can result in an electrical shock or fire hazard or obstruct the flow of heat and air. Foil is an excellent heat insulator, allowing heat to be trapped under it. This can interfere with cooking and can damage the enamel of the oven.
- Prevent aluminum foil from contacting the heating elements.
- **DO NOT HEAT UNOPENED FOOD CONTAINERS:** A buildup of pressure can cause the containers to burst.
- **DO NOT USE FLAMMABLE PRODUCTS TO CLEAN THE OVEN.**
- Do not clean, rub, damage or remove the oven door gasket. It is essential for a good, tight seal during baking and when the self-clean cycle is engaged. Replace the oven door gasket if it becomes damaged or encrusted with food residue.
- **ONLY QUALIFIED SERVICE PERSONNEL SHOULD PERFORM REPAIRS.** Service personnel must disconnect the power supply before servicing this unit.

### State of California Proposition 65 Warning



#### **WARNING**

This product can expose you to chemicals including vinyl chloride, which is known to the State of California to cause cancer and birth defects or other reproductive harm. For more information go to [www.P65Warnings.ca.gov](http://www.P65Warnings.ca.gov).

# Important Safety Instructions



- Do Not Use Water on Grease Fires - Smother fire or flame or use dry chemical or foam-type extinguisher.
- Use Only Dry Potholders - Moist or damp potholders on hot surfaces may result in burns from steam. Do not let potholder touch hot heating elements. Do not use a towel or other bulky cloth.
- Do not stand or sit on the oven door.
- Remove all packing materials and temporary labels from the oven.
- Record the Model and Serial number on Page 2 of this booklet. The Model and Serial number are on the appliance ID plate. The ID plates are visibly located on the oven door frame. THE ID PLATE MUST NOT BE REMOVED.
- BEFORE BAKING FOR THE FIRST TIME, turn on the oven to burn off any dirt, oil or grease remaining from the manufacturing process. Turn the oven on and set to 450°F(230 °C) for 20 to 30 minutes.

## How to read the user manual

This user manual uses the following reading conventions:

### Instructions



General information on this user manual, on safety and final disposal.

### Description



Description of the appliance and its accessories.

### Use



Information on the use of the appliance and its accessories, cooking advice.

### Cleaning and maintenance



Information for proper cleaning and maintenance of the appliance.



Safety instructions



Information



Advice

1. Use instruction sequence.
  - Single use instruction.

## SAVE THESE INSTRUCTIONS



# Description

## 1 Description

### 1.1 General Description

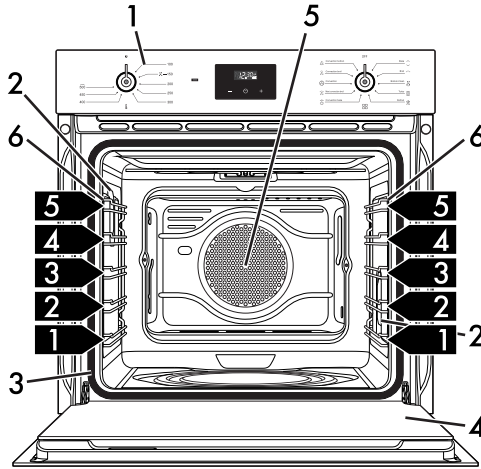

1 Control panel

2 Oven light

3 Seal

4 Door

5 Fan

6 Rack/tray support frames

**1,2,3** Frame shelf

### 1.2 Control panel

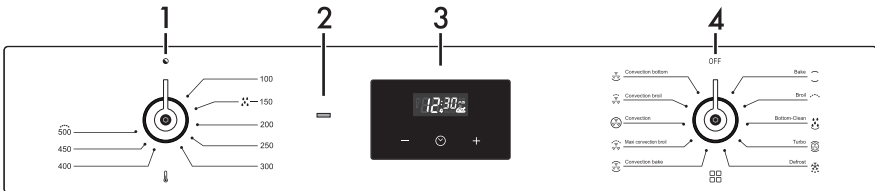



## 1 Temperature knob

This knob allows you to select the cooking temperature and the Vapor Clean temperature (on some models only).

Turn the knob clockwise to the required value, between the minimum and maximum settings.

## 2 Thermostat indicator light

When the indicator light is flashing, it indicates that the oven is heating up to reach the set temperature. Once the temperature has been reached, the light remains lit until the oven is turned off.

## 3 Programmer clock

Useful for displaying the current time, setting programmed cooking operations and setting the timer.

## 4 Function knob

The oven's various functions are suitable for different cooking modes. After selecting the required function, set the cooking temperature using the temperature knob.

## 1.3 Other parts

### Positioning shelves

The appliance has shelves for positioning trays and racks at various heights. The position heights go from the bottom upwards (see 1.1 General Description).

## Cooling fan

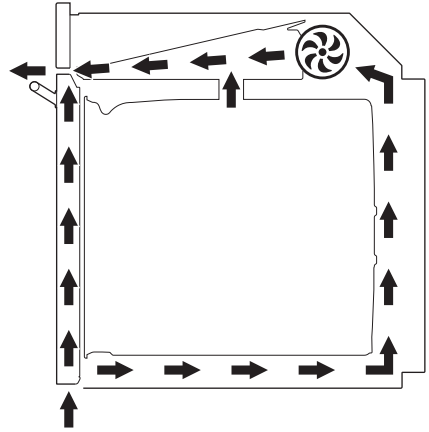

The fan cools the appliance and turns on during cooking or baking.

The fan provides a steady outflow of air from above the door, which may continue for a short time after the appliance has been turned off.

## Internal lighting

The internal lighting for the appliance turns on:

- when the door is opened;
- when any function is started, except for the Vapor Clean  function.



When the door is open, you cannot turn off the internal lighting.



## Description

### 1.4 Available accessories

#### Tray

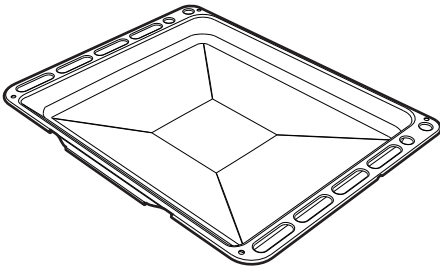

Used for collecting grease from food on the rack above and for baking cakes, pizza and baked desserts.

#### Tray rack

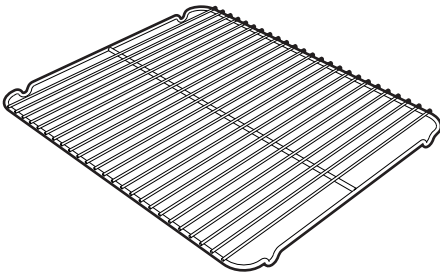

This is placed above the tray, and is used for cooking or baking foods that might drip.

#### Rack

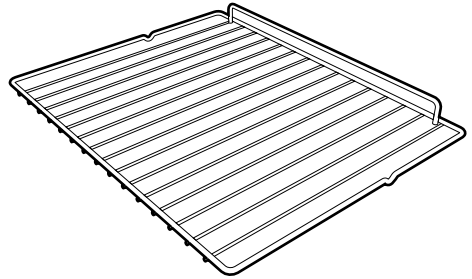

Used to hold containers containing food to be cooked.

**i** Not all accessories are provided on all models.

**i** Accessories that may come into contact with food are made of materials that comply with all legal provisions in force.

**i** Original accessories supplied or optional can be purchased at authorized service centers. Only use original manufacturer's accessories.





## 2 Use

### Warnings



**High temperature inside the oven while in use**  
**Burn hazard**

- Keep the door closed while cooking or baking.
- Use potholders or wear thermal gloves to protect your hands when handling pans that have been inside the oven.
- Do not touch the heating elements inside the oven.
- Do not pour water directly on very hot trays.
- Do not allow children near the appliance during operation.



**High temperature inside the oven while in use**  
**Danger of fire or explosion**

- Do not use spray products near the appliance.
- Do not use or store flammable materials near the appliance.
- Do not use plastic dishes or containers for cooking or baking food.
- Do not put sealed tin cans or containers in the oven.
- Do not leave the appliance unattended during cooking operations that could release fats or oils.
- Remove all trays and racks that will not be used during cooking or baking.



**Improper use**

**Risk of damage to enameled surfaces**

- Do not cover the bottom of the oven with sheets of aluminum or tin foil.
- If you wish to use parchment paper, place it so that it will not interfere with the hot air circulation inside the oven.
- Do not place pots or pans directly on the bottom of the oven.
- Do not pour water directly on very hot trays.

### 2.1 First use

1. Remove all protective film from the outside and inside of the appliance and accessories.
2. Remove all labels (except the nameplate with technical data) from the inside of the oven and accessories.
3. Remove and wash all accessories of the appliance (see "Cleaning inside the oven").
4. To remove any production residues, turn the oven on to the maximum cooking temperature for at least 20 minutes (see "Using the oven").



# Use

## 2.2 Use of accessories

### Racks and trays

Racks and trays must be inserted into the side guides until they stop.

- The mechanical safety locks that prevent accidental removal of the racks must face downward and towards the rear of the oven.

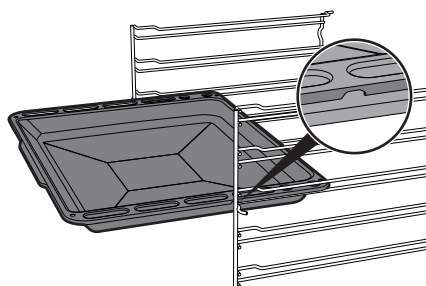
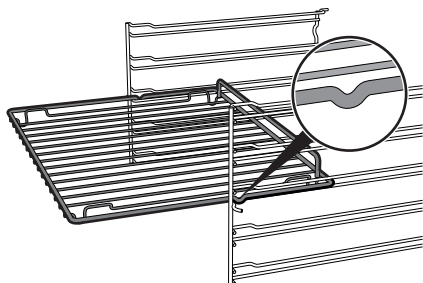

Insert the racks and trays gently into the oven and push back until they stop.



Clean the trays before using them for the first time to remove any manufacturing residues.

### Tray rack

The tray rack must be inserted into the tray. This way, the grease can be collected separately from the food being cooked or baked.

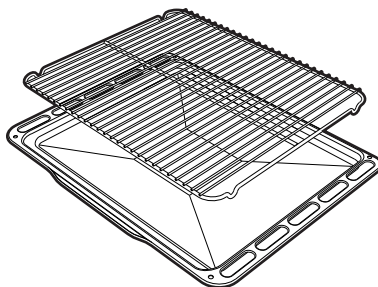

## 2.3 Using the oven

### Switching on the oven

To switch the oven on:

1. Select the cooking function using the function knob.
2. Select the temperature using the temperature knob.



Ensure that the programmer clock shows the cooking duration symbol  otherwise it will not be possible to turn on the oven.

Press the key  to reset the programmer clock.



## Functions list



### Bake

As the heat comes from above and below at the same time, this system is particularly suitable for certain types of food. Traditional cooking, also known as static cooking, is suitable for cooking just one dish at a time. Perfect for all types of roasts, bread and cakes and particularly suitable for fatty meats such as goose and duck.



### Broil

The heat coming from the broiler element gives perfect broiling results above all for thin and medium thickness meat and, in combination with the rotisserie (where fitted), gives the food an even browning at the end of cooking. Perfect for sausages, ribs and bacon. This function enables large quantities of food, particularly meat, to be grilled evenly.



### Bottom

The heat coming just from the bottom allows you to complete the cooking of foods that require a higher bottom temperature, without affecting their browning. Perfect for cakes, pies, tarts and pizzas.



### Turbo

The combination of convection cooking and traditional cooking allows different foods to be cooked on several levels extremely quickly and efficiently, without odors and flavors mingling. Perfect for large volumes that call for intense cooking.



### Defrost

Rapid defrosting is helped by switching on the fan provided and the top heating element that ensure uniform distribution of low temperature air inside the oven.



### Convection bake

The operation of the fan, combined with traditional cooking, ensures uniform cooking even with complex recipes. Perfect for cookies and cakes, even when simultaneously cooked on several levels. (For multiple-level cooking, we recommend using the 2<sup>nd</sup> and 4<sup>th</sup> shelves.)



### Maxi convection broil

The air produced by the fan softens the strong heatwave generated by the broiler, roasting even very thick foods perfectly. Perfect for large cuts of meat (e.g. pork shank).



### Convection

The combination of the fan and the convection heating element (incorporated in the rear of the oven) allows you to cook different foods on several levels, as long as they need the same temperatures and same type of cooking. Hot air circulation ensures instant and uniform distribution of heat. It will be possible, for instance, to cook fish, vegetables and cookies simultaneously (on different levels) without mixing odors and flavors.



### Convection broil

Through the combined action of the fan and the heat of the central element only, this function is perfect for rapid cooking and au gratin cooking of small quantities of food (particularly meats), by bringing together the dietary advantages of the broiler and the even cooking of the fan.



### Convection bottom

The combination of the fan with just the bottom heating element allows cooking to be completed more rapidly. This system is recommended for sterilizing or for finishing off the cooking of foods which are already well-cooked on the surface, but not inside, and therefore need a little more heat. Perfect for any type of food. In pyrolytic models, the special defrost and proofing functions are brought together under the same function.



### Clean

This function makes cleaning easier using the steam produced by a little quantity of water poured onto the appropriate drawing placed on the bottom.



## 2.4 Programming clock



Value decrease key



Clock key



Value increase key



Ensure that the programmer clock shows the cooking duration symbol , otherwise it will not be possible to turn on the oven.



Press the key  to reset the programmer clock.

## Setting the time





If the time is not set, the oven will not switch on.

On the first use, or after a power failure, the digits  will be flashing on the appliance's display.

1. Keep the clock key  for two seconds. The dot between the hours and the minutes flashes.
2. The time can be set via the value increase key  and value decrease key . Keep the key pressed in to increase or decrease rapidly.
3. Wait 7 seconds. The dot between the hours and the minutes stops flashing.

The symbol  on the display indicates that the appliance is ready to start cooking.



To change the time, hold down the value increase key  and value decrease key  at the same time for two seconds, then set the time.









# Use

## Minute minder timer

**i** The minute minder timer does not stop the cooking operation but rather informs the user when the set time has run out.









The minute minder timer can be activated at any time.

1. Keep the clock key  pressed for a few seconds. The display shows the figures  and the symbol  flashing between the hours and minutes.
2. Use the value increase  and value decrease  keys to set the number of minutes required.
3. Wait approx. 5 seconds without pressing any key to finish setting the minute minder. The current time and the symbol  appear on the display.
4. A buzzer will sound when the set time is reached.
5. Press the value decrease key  to turn the buzzer off.

**i** The minute minder timer can be set from 1 minute to a maximum of 23 hours and 59 minutes.

## Timed cooking

**i** Timed cooking is the function which allows a cooking operation to be started and then ended after a specific length of time set by the user.

1. Keep the clock key  pressed for a few seconds. The display shows the figures  and the symbol  flashing between the hours and minutes.
2. Press the clock key  again. On the display the digit  appear alternating with the digit  and the symbol  flashing under the minutes.
3. Use the value increase  and value decrease  keys to set the required minutes of cooking.
4. Select a function and a cooking temperature.



5. Wait approx. 5 seconds without pressing any key in order for the function to activate. The current time and the symbol **auto** will appear on the display.

At the end of cooking the heating elements will be deactivated. On the display, the symbol  turns off, the symbol

**auto** flashes and the buzzer sounds.

6. To turn the buzzer off, simply press one of the programmer clock keys.

7. Press the clock key  to reset the programmer clock.

**i** It is not possible to set a cooking time of more than 10 hours.

 To cancel the set programming press and hold down the value increase **+** and the value decrease **-** keys at the same time and then turn the oven off manually.

## Programmed cooking

**i** Programmed cooking is the function which allows a cooking operation to be started at a set time and then ended after a specific length of time set by the user.

1. Set the cooking time as described in the previous point "Timed cooking".
2. Press the clock key  again. On the

display the digit **End**  appear alternating with the current time

digit **11:30**  and the symbol

**auto** flashing under the minutes.

3. Use the value increase **+** and value decrease **-** to set the cooking end time.
4. Select a function and a cooking temperature.
5. Wait approx. 5 seconds without pressing any key in order for the function to activate. The current time and the symbol **auto** will appear on the display. The symbol  disappear on the display.



## Use

At the end of cooking the heating elements will be deactivated. On the display, the symbol  turns off, the symbol

**auto** flashes and the buzzer sounds.

6. To turn the buzzer off, simply press one of the programmer clock keys.

7. Press the clock key  to reset the programmer clock.

### 12h or 24h format



The default mode is 12h format.

1. Keep the value increase key  for a few seconds. The symbols **AM** or **PM** disappear on the display and 24h format is set.

2. Keep the value increase key  for a few seconds to return in 12h format.

### Selecting the buzzer

The buzzer can have 3 tones.

1. Hold down the value increase  and value decrease  keys at the same time.

2. Press the clock key . On the display the digit  appear.

3. Press the value decrease key  to select a different buzzer tone

 or .

## 2.5 Cooking tips

### General tips

- Use a convection function to achieve uniform cooking at several levels.
- Increasing the temperature does not shorten cooking or baking times (the food could be well cooked on the outside and undercooked on the inside).





### Tips for cooking meats

- Cooking times vary depending on the thickness and quality of the meat, and on consumer tastes.
- Use a meat thermometer when cooking roasts, or simply press on the roast with a spoon. If it feels hard, it is ready; otherwise, it needs to roast a bit longer.

### Tips for cooking with the broiler and convection broiler

- The meat can be grilled starting with a cold oven or with the oven preheated if you want to change the effect of the cooking.
- With the convection broiler function, it is recommended that the oven be preheated before broiling.
- We recommend placing the food at the center of the rack.

### Tips for baking cakes and cookies

- It is preferable to use dark metal pans, which help to absorb the heat better.
- The temperature and baking duration depend on the quality and consistency of the dough.
- To check whether the cake is baked through, stick a toothpick into its highest point at the end of the baking time. If the dough does not stick to the toothpick, the dessert is cooked.

- If the dessert goes flat when it comes out of the oven, on the next occasion reduce the set temperature by about 50°F, selecting a longer cooking time if necessary.

### Tips for defrosting and proving

- With the wrapping removed, place frozen foods into a lidless container and place it on the first rack in the oven.
- Do not overlap foods.
- To defrost meat, use a rack placed on the second level and a tray placed on the first level. This way, the meat does not remain in contact with the liquid from thawing.
- The most delicate parts can be covered with aluminum foil.
- For good proving, place a container of water at the bottom of the oven.

### To save energy

- Turn off the oven a few minutes before the time required. Cooking will continue for the remaining minutes with the heat already accumulated inside the oven.
- Do not open the oven door very often to avoid heat loss.
- Always keep the inside of the appliance clean.
- (Where present) If not used, remove the pizza tray and place the cover in its special location.



# Use

## Cooking information chart

Food	Weight (lbs.)	Function	Shelf	Temp. (°F)	Time (minutes)	
Lasagna	6,6 - 8,8	Bake	1	410 - 450	45 - 50	
Baked pasta	6,6 - 8,8	Bake	1	410 - 450	45 - 50	
Roast veal	4,4	Turbo	2	360	90 - 100	
Pork	4,4	Turbo	2	360	70 - 80	
Sausages	3,3	Convection broil	4	500	15	
Roast beef	2,2	Turbo	2	500	40 - 45	
Roast rabbit	3,3	Convection bake	2	360	70 - 80	
Turkey breast	6,6	Turbo	2	360	110 - 120	
Roast pork neck	4,4 - 6,6	Turbo	2	360	170 - 180	
Roast chicken	2,6	Turbo	2	360	65 - 70	
					1 <sup>st</sup> surface	2 <sup>nd</sup> surface
Pork chops	3,3	Convection broil	4	500	15	5
Spare ribs	3,3	Convection broil	4	500	10	10
Bacon	1,5	Broil	5	500	7	8
Pork fillet	3,3	Convection broil	4	500	10	5
Beef fillet	2,2	Broil	5	500	10	7
Salmon trout	2,6	Turbo	2	300	35 - 40	
Monkfish	3,3	Turbo	2	300	60 - 65	
Turbot	3,3	Turbo	2	300	45 - 50	
Pizza	2,2	Turbo	2	500	8 - 9	
Bread	2,2	Convection bake	2	360 - 410	25 - 30	
Focaccia	2,2	Turbo	2	360	20 - 25	
Sponge cake	2,2	Convection bake	2	300	55 - 60	
Jam tart	2,2	Convection bake	2	300	35 - 40	
Ricotta cake	2,2	Convection bake	2	300 - 360	55 - 60	
Jam tarts	2,2	Turbo	2	300	20 - 25	
Paradise cake	2,6	Convection bake	2	300	55 - 60	
Cream puffs	2,6	Turbo	2	360	80 - 90	
Light sponge cake	2,2	Convection bake	2	300 - 360	55 - 60	
Rice pudding	2,2	Turbo	2	300	55 - 60	
Brioches	1,3	Convection bake	2	300	30 - 35	

The times indicated in the table do not include preheating times and are provided as a guide only.



## 3 Cleaning and maintenance

### Warnings



**Improper use**

**Risk of damage to surfaces**

- Do not use steam jets to clean the appliance.
- Do not use cleaning products containing chlorine, ammonia or bleach on the steel parts or those with metallic surface finishes (e.g. anodizing, nickel or chrome plating).
- Do not use abrasive or corrosive detergents on the glass parts (e.g. powder products, stain removers or metal scouring pads).
- Do not use rough or abrasive materials or sharp metal scrapers.



We recommend using cleaning products distributed by the manufacturer.

### Ordinary daily cleaning

Always use only specific products that do not contain abrasives or chlorine-based acids.

Pour the product on a damp cloth and wipe the surface, rinse thoroughly and dry with a soft fabric or microfiber cloth.

### Food stains or residues

Do not use steel wool or sharp scrapers: they will damage the surface.

Use ordinary, non-abrasive products, with the aid of wooden or plastic tools if necessary. Rinse thoroughly and dry with a soft fabric or microfiber cloth.

Do not let sugar-based food residues (e.g. jam/jelly) dry within the appliance as they can ruin the coating on the inside of the appliance.

### 3.1 Surface cleaning

To maintain the surfaces, you must clean them regularly after each use once they have cooled down.



# Cleaning and Maintenance

## 3.2 Cleaning the door

### Removing the door

To facilitate cleaning, we recommend that you remove the door and place it on a towel.

To remove the door, proceed as follows:

1. Open the door completely and insert two pins into the holes in the hinges, as shown in the image.

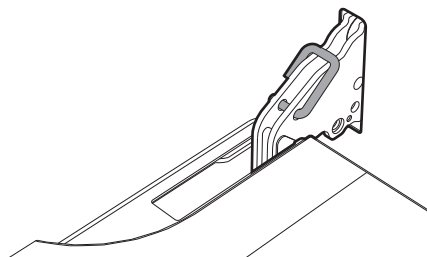

2. Grasp the door on both sides with both hands. Lift it, forming an angle of about 30°, and remove it.

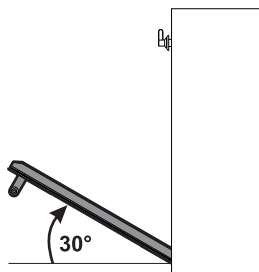

3. To remount the door, insert the hinges into the slots on the oven, making sure that the grooves **A** fit tightly in the slots. Lower the oven door and once it is in position, remove the pins from the holes in the hinges.

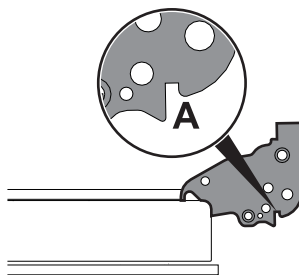

### Cleaning the door glazing

We recommend always keeping the glass doors thoroughly clean. Use paper towels. If there are tough to clean spots, use a damp sponge and regular detergent.



We recommend using cleaning products distributed by the manufacturer.



## Removing the inner glass

To facilitate cleaning, the inner glass panels of the door can be removed.

1. Remove the inner glass panel by pulling it gently upward at the rear, moving it as indicated by the arrows (1).
2. Then pull the front part of the glass panel upwards (2). This way, the four pins attached to the glass panel are disengaged from their grooves in the door.

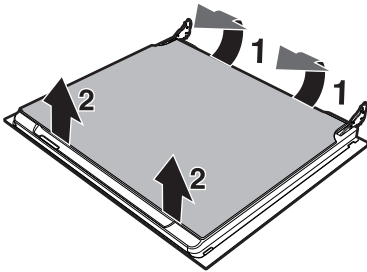

3. Some models have an intermediate glass panel. Remove the intermediate panel by lifting it upwards.

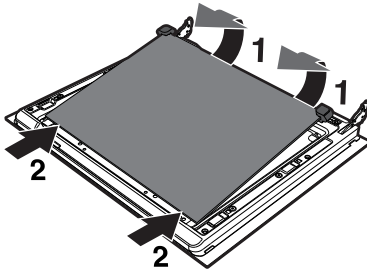

4. Clean the external glass panel and the one you just removed. Use paper towels. If there are tough to clean spots, use a damp sponge and mild detergent.

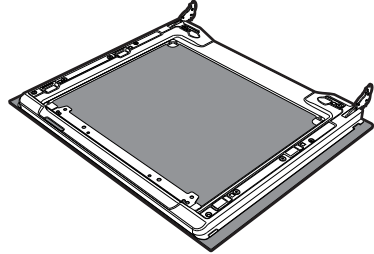

5. Reinsert the glass panels in the reverse order of removal.
6. Reposition the inner glass panel. Make sure you center and insert the four pins into their grooves in the door, using a little pressure.

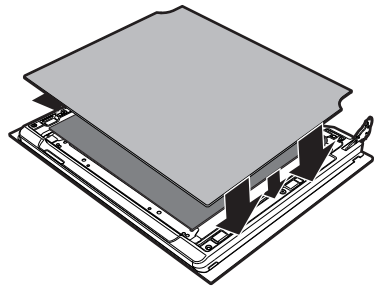



## Cleaning and Maintenance

### 3.3 Cleaning inside the oven

Proper maintenance of the oven's interior requires that it be cleaned regularly, after allowing it to cool.

Avoid leaving dried up food inside the oven because it could damage the enamel surface.

Before cleaning, take out all removable parts.

To make cleaning easier, we recommend the removal of:

- the door;
- the frame supports for racks/trays;
- the seals.



If you are using specific cleaning products, we recommend operating the appliance at the maximum temperature for about 15-20 minutes to remove any residues.

### Removal of the frame supports for racks/trays

Removing the guide frames makes it easier to clean the sides of the oven. This must be done each time you use the automatic cleaning cycle (only on some models).

To remove the guide frames:

- Pull the frame towards the inside of the oven to unhook it from its housing **A**, and then slide it out of the grooves at the back **B**.

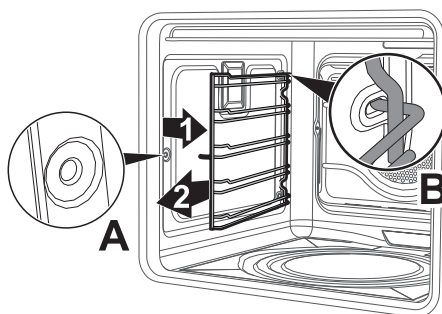

- When you have finished cleaning the oven, repeat the procedures indicated above to reposition the guide frames.



## 3.4 Vapor Clean



Vapor Clean is an assisted cleaning procedure which facilitates the removal of dirt. With this process, it is possible to clean the inside of the oven very easily. The dirt residues are softened by the heat and water vapor for easier removal afterwards.



**Improper use**  
**Risk of damage to surfaces**

- Remove from the inside of the oven any food residues or large spills from previous cooking operations.
- Carry out assisted oven cleaning operations only when the oven is cold.

### Preliminary operations

Before starting the Vapor Clean cycle:

- Completely remove all accessories from inside the oven. The roof lining can be left inside the oven.

- Pour approx. 40 cc of water onto the floor of the oven. Make sure it does not overflow out of the cavity.

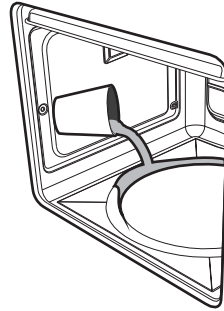

- Spray a water and mild liquid detergent inside the oven using a spray nozzle. Direct the spray against the side walls, upwards, downwards and towards the deflector.

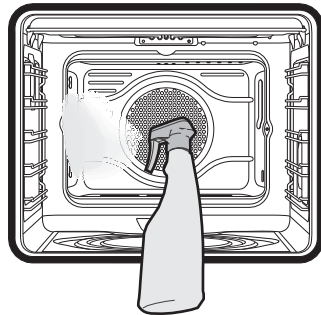

- Close the door.



We recommend spraying approx. 20 times at the most.



## Cleaning and Maintenance

### Vapor Clean setting

1. Turn the function knob and the temperature knob to the  symbol.
2. Set a cooking time of 18 minutes using the cooking time procedure described in more detail in "Programmed cooking".
3. The Vapor Clean cycle starts approximately 6 seconds after the last press on the programmer's keys.
4. At the end of the Vapor Clean cycle, the timer will deactivate the oven heating elements, the buzzer will start to sound and the numbers on the dial will flash.

### End of the Vapor Clean cycle

5. Open the door and wipe away the less stubborn dirt with a microfiber cloth.
6. Use an anti-scratch sponge with brass filaments on tougher encrustations.
7. In case of grease residues, use specific oven cleaning products.
8. Remove the water left inside the oven.
9. For improved hygiene and to avoid food being affected by any unpleasant odors, we recommend drying the oven using a convection function at 320°F for approximately 10 minutes.



We recommend that you use rubber gloves for these operations.



For easier manual cleaning of the parts that are difficult to reach, we recommend that you remove the door.





## 3.5 Extraordinary maintenance

### Replacing the oven light



Live parts  
Danger of shock

- Switch off the electrical supply to the appliance.

1. Remove all accessories inside the oven.
2. Remove the frame supports for racks/trays.
3. Remove the light cover using a tool (e.g. a spoon).



Be careful not to scratch the enamel of the oven walls.

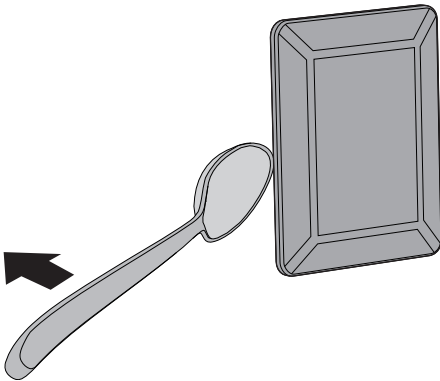

4. Loosen and remove the light bulb.

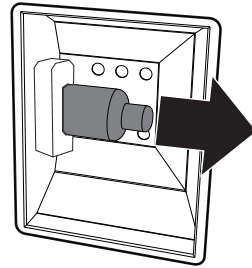

Do not touch the halogen bulb with your fingers; cover them with an insulating cloth.

5. Replace the bulb with a similar one (40 W).
6. Reattach the cover. Leave the inside of the glass molding (A) facing the door.

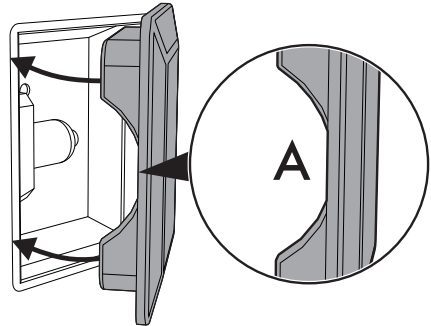

7. Press the cover firmly so that it adheres tightly to the light bulb holder.



# Cleaning and Maintenance

## Removing and re-inserting the gasket

To remove the oven's gasket:

- Unhook the hooks located at the four corners and pull the gasket out.

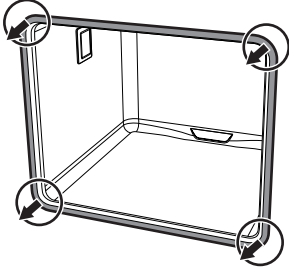

To re-insert the oven's gasket:

- Hook the hooks located at the four corners of the gasket.

## Tips for maintenance of the oven gasket

The oven gasket must be soft and elastic.

8. To keep the gasket clean, use a soft sponge and rinse with warm water.