



FQ55UFX

Contents

1	Safety Warnings	
1.1	Warning	1
1.2	Meaning of safety warning symbols	2
1.3	Electricity-related warnings	2
1.4	Warnings for use	3
1.5	Warnings for placement	3-4
1.6	Warnings for energy	4
1.7	Warnings for disposal	4
2	Proper Use of Refrigerator	
2.1	Levelling feet	5
2.2	Leveling door	6
2.3	Starting	7
2.4	Energy saving tips	7
2.5	Placement	8
3.	Structure and Functions	
3.1	Key components	9-10
3.2	Functions	11 -12
4	Maintenance and Care of the Refrigerator	
4.1	Overall cleaning	13
4.2	Cleaning of door tray	13
4.3	Cleaning of shelf	14
4.4	Cleaning of freezer lower drawer	14
4.5	Installing the water line	15
4.6	Defrosting	16
4.7	Out of operation	16
5	Troubleshooting.....	17

1 Safety Warnings

1.1 Warning



Warning - risk of fire/flammable materials

THIS appliance is intended to be used in household and in hotels, motels, and other residential type, bed and breakfast environments.

THIS appliance is not intended for use by persons (including children) with reduced physical capacity, or lack of experience and knowledge, unless they have been given supervision or instruction concerning use of the appliance by a person responsible for their safety. Children should be supervised to ensure that they do not play with the appliance.

IF the supply cord is damaged, it must be replaced by the manufacturer, its service agent, or similarly qualified persons to avoid a hazard.

DO not store explosive substances such as aerosol cans with a flammable propellant in this appliance.

THE appliance must be unplugged before carrying out maintenance on the appliance.

WARNING: Keep ventilation openings, in the appliance enclosure or in the built-in structure clear of obstruction.

WARNING: Do not use mechanical devices or other means to accelerate the defrosting process

WARNING: Do not damage the refrigerant circuit.

WARNING: Do not use electrical appliances inside the food storage compartments of the appliance unless they are of the type recommended by the manufacturer.

WARNING: Discard the refrigerator according to local regulation for its refrigerant.

WARNING: When positioning the appliance, ensure the supply cord is not damaged.

WARNING: Do not locate multiple portable socket-outlets or portable power supplies at the rear of the appliance.

DO not use extension cords or ungrounded (two prong) adapters.

DANGER: Risk of child entrapment. Before you discard of your old refrigerator or freezer:

— Take off the doors.

— Tape and leave the shelves in place so that children may not easily get inside.

THE refrigerator must be disconnected from the source of electrical supply before attempting the installation of accessory.

WARNING: Connect to potable water supply only. (Suitable for ice making machine)

1.2 Meaning of the Symbols Safety Warnings



This is a prohibition symbol.
Any in compliance with instructions marked with this symbol may result in damage to the product or endanger the personal safety of the user.



Symbol
warning

This is a warning symbol.
It is required to operate in strict observance of instructions marked with this symbol; otherwise, damage to the product or personal injury may be caused.



Warning

This is a cautioning symbol.
Instructions marked with this symbol require special caution. Insufficient caution may result in slight or moderate injury or damage to the product.

This manual contains important safety information which shall be observed by the users.

1.3 Electricity-Related Warnings

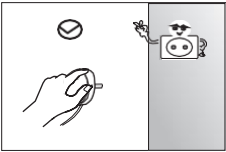

- Do not pull the power cord when pulling the power plug of the refrigerator. Please firmly grasp the plug and pull out it from the socket directly.
- To ensure safe use, do not damage the power cord or use the power cord when it is damaged or worn.



- Please use a dedicated power socket and the power socket shall not be shared with other electrical appliances. The power plug should be firmly contacted with the socket or else fires might be caused.
- Please ensure that the grounding plug of the power socket is equipped with a reliable grounding line.



- Please turn off the valve of leaking gas and then open the doors and windows in case of leakage of gas and other flammable gases from other appliances. Do not unplug the refrigerator and other electrical appliances considering that spark may cause a fire.

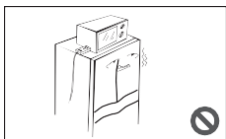

- Do not place electrical appliances on the top of the appliances, unless they are of the type recommended by the manufacturer.

1.4 Warnings for Use

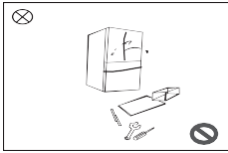

- Do not arbitrarily disassemble the refrigerator, nor damage the refrigerant circuit; maintenance of the appliance must be conducted by an authorized service technician.
- Damaged power cord must be replaced by the manufacturer

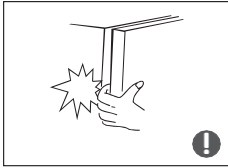

- The gaps between refrigerator doors and refrigerator body are small, be sure not to put your hand in these areas to prevent from squeezing the finger. Please be gentle when close the refrigerator door to avoid falling articles.
- Do not pick up foods or containers with wet hands in the freezer when the refrigerator is running, especially metal containers in order to avoid freezer burn.

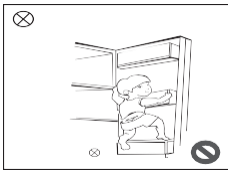

- Do not allow any child to get into or climb the refrigerator; otherwise, suffocation or falling injury of the child may occur.

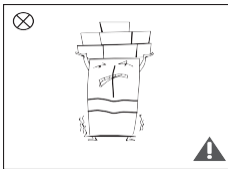

- Do not place heavy objects on the top the refrigerator considering that objects may fall when close or open the door, and accidental injuries might be caused.
- Please pull out the plug-in case of power failure or cleaning. Do not connect the refrigerator to power supply within five minutes to prevent damages to the compressor due to successive starts.

1.5 Warnings for Placement of Items

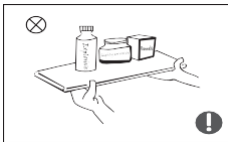

- Do not put flammable, explosive volatile and highly corrosive items in the refrigerator to prevent damages to the product or fire accidents.
- Do not place flammable items near the refrigerator to avoid fires.

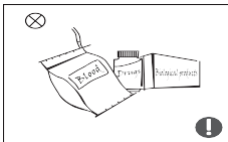

- The refrigerator is intended for household use, such as storage of food; it shall not be used for other purposes, such as storage of blood, or biological products, etc.



- Do not store beer, beverage or other fluid contained in bottles or enclosed containers in the freezer, or otherwise the bottles or enclosed containers may crack due to freezing to cause damages.

1.6 Warnings for Energy

Warning for energy:

- 1) Refrigerating appliances might not operate consistently (possibility of defrosting of contents or temperature becoming too warm in the frozen food compartment) when set for an extended period below the cold end of the range of temperatures for which refrigerating appliance is designed.
- 2) Carbonated drinks should not be stored in food freezer compartments or cabinets or in low-temperature compartments or cabinets, and that some products such as water ices should not be consumed too cold.
- 3) The need to not exceed the storage time(s) recommended by the food manufacturers for any kind of food and particularly for commercially quick-frozen food in food-freezer and frozen-food storage compartments or cabinets.
- 4) The precautions necessary to prevent an undue rise in the temperature of the frozen food while defrosting the refrigerating appliance, such as wrapping the frozen food in several layers of newspaper.
- 5) The fact that a rise in temperature of the frozen food during, maintenance or cleaning could shorten the storage life.

Warnings for disposal

Refrigerant and cyclopentane foaming material used for the refrigerator are flammable, Therefore, when the refrigerator is scrapped, it shall be kept away from any fire source and be recovered by a recovering company with corresponding qualification other than be disposed by combustion, to prevent damage to the environment or any other harm.



When the refrigerator is scrapped, disassemble the doors, and remove gasket of door and shelves: put the doors and shelves in a proper place, to prevent trapping of any child.



Correct arrangement of this product:

This mark indicates that this product should not be discarded with other household waste. To avoid possible damage to the environment or human health from the uncontrolled disposal of waste, receive it responsibly to promote the sustainable reuse of material resources. To return your used device, use the collection and recovery systems or contact the retailer where you purchased the product.

2 Proper Use of Refrigerator

2.1 Levelling Feet

1) Precautions before operation:

Information in the instruction manual is only for reference. Before operation, it shall be ensured that the refrigerator is disconnected from power. Before adjusting the leveling feet, precautions shall be taken to prevent any personal injury.

2) Schematic diagram of the levelling feet.

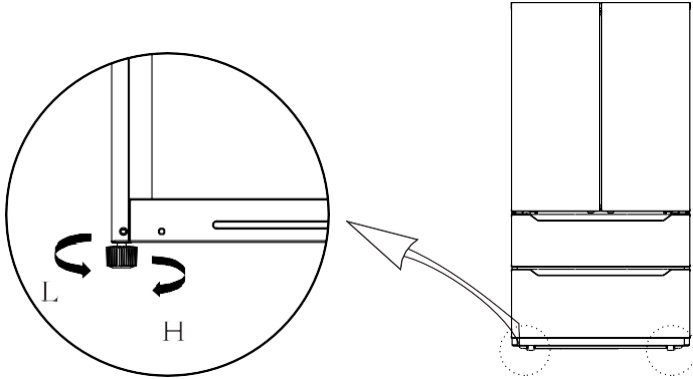

(The picture above is only for reference. The actual configuration will depend on the physical product or distributor's statement)

3) Adjusting procedures:

- a. Turn the feet clockwise to lower the refrigerator.
- b. Turn the feet counterclockwise to lower the refrigerator.
- c. Adjust the right and left feet based on the procedures above to a horizontal level.

2.2 Leveling Door

1) Precautions before operation:

Information in the operation is only for reference.

Before operation, it shall be ensured that the refrigerator is disconnected from power.

Before adjusting the door, precautions shall be taken to prevent any personal injury.

2) Schematic diagram of the levelling feet

List of tools to be provided by the user	
	plier

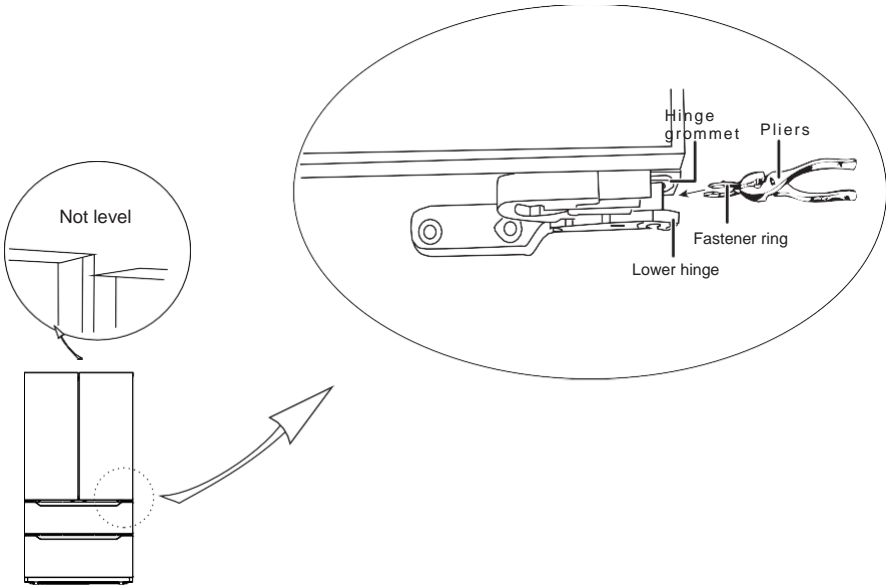

(The picture above is only for reference. The actual configuration will depend on the physical product or statement by the distributor)

1) Raise the lower door up of the higher door.

2) Insert the supplied fastener-ring by using plier in the gap between the hinge-grommet and the lower hinge.

The number of fasten-rings you will need to insert depends on the gap.

2.3 Starting

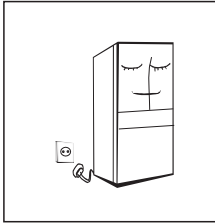

- Before initial start, keep the refrigerator still for two hours before connecting it to power supply.
- Before putting any fresh or frozen foods, the refrigerator shall have run for 2-3 hours, or for above 4 hours in summer when the ambient temperature is high.

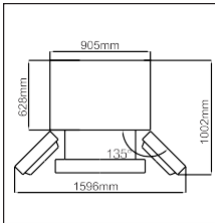

- Spare enough space for convenient opening of the doors and drawers or statement by the distributor.

2.4 Energy Saving Tips

- The appliance should be in the coolest area of the room, away from heat producing appliance or heating ducts, and out of the direct sunlight.
- Let hot foods cool to room temperature before placing in the appliance. Overloading the appliance forces the compressor to run longer. Foods that freeze too slowly may lose quality, or spoil.
- Be sure to wrap food properly, and wipe containers dry before placing them in the appliance. This cuts down on frost build-up the appliance.
- Appliance storage bin should not be lined with aluminum foil, wax paper toweling. Liners interfere with cold air circulation, making the appliance less efficient.
- Organize and label food to reduce door openings and extended searches. Remove as many items as needed at one time and close the door as soon as possible.

2.5 Placement

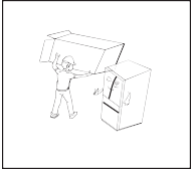

- Before use, remove all packing materials, including bottom cushions, foam pads and tapes inside of the refrigerator; tear off the protective film on the doors and the refrigerator body.

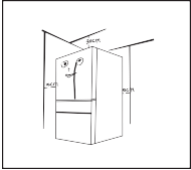

- Keep away from heat and avoid direct sunlight. Do not place the freezer in moist or watery places to prevent rust or reduction of insulating effect.
- Do not spray or wash the refrigerator; do not put the refrigerator in moist places easy to be splashed with water so as not to affect the electrical insulation properties of the refrigerator.

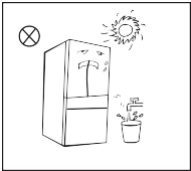

- The refrigerator is placed in a well-ventilated indoor place; the ground shall be flat, and sturdy (rotate left or right to adjust the adjustable leg for levelling if unstable)

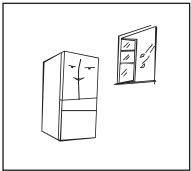

- The top space of the refrigerator shall be greater than 12", and the refrigerator should be placed against a wall with a free distance more than 4" to facilitate heat dissipation.

ⓘ Precautions before installation:

Before installation or adjusting of accessories it shall be ensured that the refrigerator is disconnected from power.

Precautions shall be taken to prevent fall of the handle from causing any personal injury.

3 Structure and Functions

3.1 Key Components

(Refrigerator chamber)

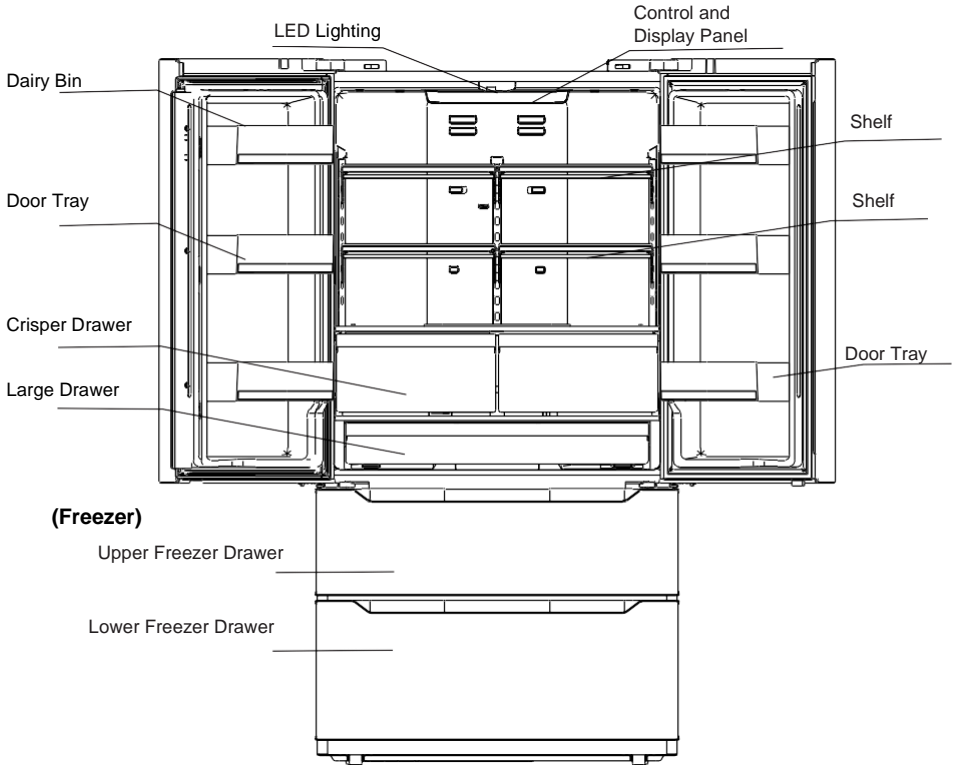

(The picture above is only for reference: the actual configuration will depend on the physical products or statement by the distributor).

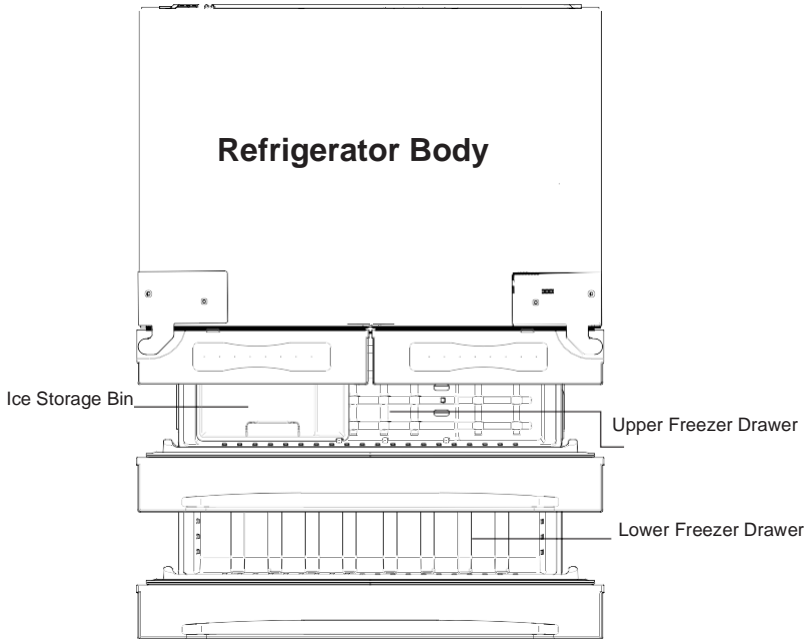

(The picture above is only for reference; The actual configuration will depend on the physical product)-

Refrigerating Chamber -

- The refrigerating chamber is suitable for storage of a variety of fruits, vegetables, beverages, and other food consumed in the short term.
- Cooked foods shall not be put in the refrigerating chamber until cooled to room temperature.
- Foods are recommended to be sealed before putting into the refrigerator.
- The glass shelves can be adjusted up or down for a reasonable amount of storage space and easy use.

_ Freezing Chamber -

- The lower temperature freezing chamber may keep food fresh for a long time and it is mainly used to store frozen foods and making ice.
- The freezing chamber is suitable for storage of meat, fish, and other foods not to be consumed in short term.
- Chunks of meat are preferably to be divided into small pieces for easy access. Please note food shall be consumed within the shelf time.

Note: Storage of too much food during operation after the initial connection to power may adversely affect the freezing effect of the refrigerator. Foods stored shall not block the air outlet; or otherwise, the freezing effect will also be adversely affected.

3.2 Functions



(The picture above is only for reference. The actual configuration will depend on the physical product or statement by the distributor)

1. Buttons

- ① Ice-making button
- ② Super cool button
- ③ Temperature adjusting button of refrigerator
- ④ Temperature adjusting button of freezer chamber.
- ⑤ Super freeze button
- ⑥ Lock/Unlock button

2. Display

- a) When operating the refrigerator, the screen will totally display for 3 seconds, meanwhile the bell rings, then the screen enters the normal display of operation. (If power-on for first time, the default set temperature of the refrigerator room and the freezer room is 41°F / 0°F).
- b) It will display the set temperature of both refrigerator and freezer rooms when there is not fault.
- c) Under normal circumstances, the display light will go out after 30 seconds in lock state, button operation in display panel will initiate the display screen; If the opening door action initiate the display screen; the display light will go out immediately when the door is closed; when the "fault code visible" type of fault occurs, the display screen lights up, and will go out after 30 seconds.

3. Lock / Unlock

- a) In the unlock state, press, and hold the lock/unlock button for 3 seconds to enter the lock state and the buzzer sound rings.
- b) In the lock state, press and hold the lock button for 3 seconds to enter the unlock state and the buzzer sound rings.
- c) It will enter the lock state if there is no opening door action or any buttons operation within 30 seconds.
- d) The alarm sound can be stopped by pressing any one button in lock state, but all other button operations need to be performed in unlock state. If you operate in the lock state, an error beep will be given.

4. Refrigerator Temperature Setting

Press the temperature adjustment button of refrigerator room to change the set temperature of refrigerator chamber. Each time press the button, the set temperature will drop 1°F. when the set temperature reaches the 34°F, press the button again, the set temperature will switch to 44°F. The temperature setting will take effect after the display panel is locked.

5. Freezer Temperature Setting

Press the temperature adjusting button of freezer room to change the set temperature of freezer room. Each time click the button, the set temperature will drop 1°F when the set temperature reaches the -7°F, click the button again, the set temperature will switch to 7°F. The temperature setting will take effect after the display panel is locked.

6. Mode Setting

- 1) Press in the **SUPER COOL** button to start the super cool function. The refrigerator temperature is set at 34°F automatically, and the **SUPER COOL** icon lights up. When exiting the super cool mode, the set temperature of the refrigerator will go back to the set temperature before super cool mode.
- 2) Press the **SUPER FRZ** button to start the super freeze function. The freezer is set at -7°F automatically, and the **SUPER FRZ** icon lights up. When exit the super freeze mode, the set temperature of the freezer room will go back to the set temperature before super freeze mode.
- 3) Press the **ICE MAKER** HOLD 3S ON/OFF button, the ice-making function could be switched between on/off. When the  icons are on, it indicates that the ice-making function is activated.

7. Error Code

When the following error codes to appear on the display screen, it indicates a problem with the appliance. Although the appliance in the following fault case can still provide cool/freeze functions, but the user should contact service to ensure the normal use of refrigerator.

Error code	Error Description
E1	Temperature sensor failure of refrigerator chamber
E2	Temperature sensor failure of freezer chamber
E5	Defrost sensor error of freezer chamber
E6	Communication error
E7	Ambient temperature sensor error
EH	Humidity sensor error
Eo	Ice maker error

4. Maintenance and Care

4.1 Overall Cleaning

- Dust behind the refrigerator and on the ground shall be cleaned to improve the cooling effect and energy saving. The interior of the refrigerator should be cleaned regularly to avoid odor. Soft towels or sponge dipped in water and non-corrosive neutral detergents are suggested for cleaning. The freezer shall be cleaned with clean water and dry cloth. Open the door for natural drying before the power is turned on.
- Do not use hard brushes, clean steel balls, wire brushes, abrasives, such as toothpastes, organic solvents (such as alcohol, acetone, banana, oil, etc.), boiling water, acid or alkaline items clean refrigerator considering that this may damage the fridge surface and interior.
- Do not rinse with water so as not to affect the electrical insulation properties.

 Unplug the refrigerator to thaw and clean.



4.2 Cleaning of Door Tray

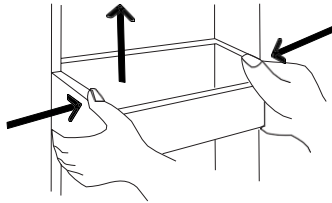

(The picture above is only for reference. The actual configuration will depend on the physical product or statement by the distributor.).

- According to the direction arrow in the figure below, use both hands to squeeze the tray, and push it upward, then you can take it out.
- After washing the tray, you can adjust its installing height in accordance with your requirement.

4.3 Cleaning of Shelf

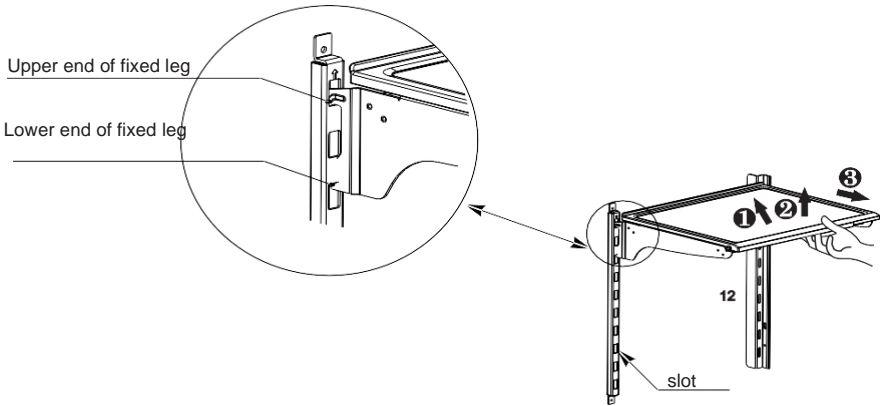

(The picture above is only for reference. The actual configuration will depend on the physical product or statement by the distributor).

- Please dismantle the cantilever shelf according to the arrows shown as above.
 - 1 Please hold the front edge of shelf and tilt the shelf inwards until the lower end of fixed leg is separates from the slot of the supporting iron.
 - 2 Uplift the whole shelf until it cannot rise anymore.
 - 3 Take out the shelf horizontally.
- During installation, put the upper end of the fixed leg into one of the upper slots on the supporting glide first and then put the lower end of the fixed leg into the third slot on the lower part of the supporting glide.

4.4 Cleaning of Freezer Lower Drawer

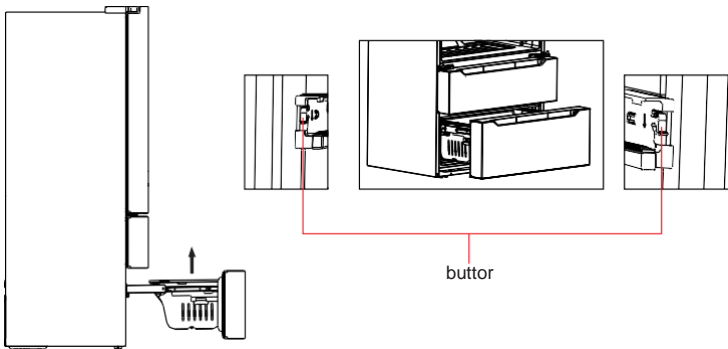

- Pull out the lower freezer drawer to the proper position.
 - As shown in the Figure, press the buttons in both slots respectively (must press both sides at the same time), pull out the freezer drawer until it stops.
 - Take out the lower drawer as directed by the arrows.
 - After cleaning, put back the drawer to original position, then close the lower drawer, the button will lock the drawer automatically.
- Note: Don't remove the lower freezer drawer if not necessary.

4.5 Installing the Water Line

Installing the water line

Water line installation kits are available as an additional accessory from your dealer or at a local hardware store.

Connection to the water supply line

1. First, shut off the main water supply line and turn the icemaker off.
2. Located the nearest cold water supply valve.
3. After connecting the water supply to the water valve, turn your main water supply back on and flush several gallons of water to clear the water supply line.

The minimum inlet water pressure : 147kPa

The maximum inlet water pressure : 834kPa;

Connecting the water line to the refrigerator

There are several items that you need to purchase to complete this connection.

You will find these items sold as a kit at your local hardware store.

1. First water tubes (supplied) insert into corresponding hole of water connector (supplied).
2. Next, water line installation kit (not included) inserts into another hole of water connector (supplied).
3. Turn water valve on and check for any leakage.

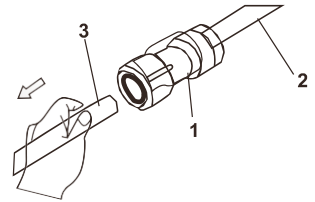
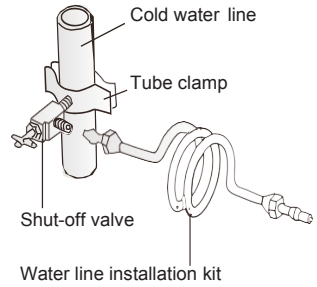

Connecting the water line to a drinkable water source

If your water line is NOT drinkable please add an external water filter.

If you must repair or disassemble the water line, cut off the plastic tubing to make sure you get a snug, leak-free connection.

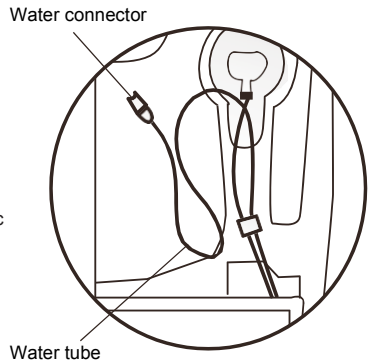

4.6 Defrosting

- The refrigerator is made based on the air-cooling principle and thus has automatic defrosting function. Frost formed due to change of season or temperature may also be manually removed by disconnection of the appliance from power supply or by wiping with a dry towel.

4.7 Out of Operation

- Power failure: In case of power failure, even if it is in summer, foods inside the appliance can be kept for several hours; during the power failure, the times of door opening shall be reduced, and no more fresh food shall be put into the appliance.
- Long-time nonuse: The appliance shall be unplugged and then cleaned; then the doors are left open to prevent odor.
- Moving: Before the refrigerator is moved, take all objects inside out, fix the glass partitions vegetable holder, freezing chamber drawers etc. with tape and tighten the levelling feet; close the doors and seal them with tape. During moving, the appliance shall not be laid upside down or horizontally or be vibrated; the inclination during movements shall be no more than 45°.

 The appliance shall run continuously once it is started. Generally, the operation of the appliance shall not be interrupted; otherwise, the service life may be impaired.

5 Trouble Shooting

You may try to solve the following simple problems by yourself. If them cannot be solved, please contact the service department

Failed operation	<p>Check whether the appliance is connected to power or whether the plug is properly in the outlet.</p> <p>Check whether the voltage is too low.</p> <p>Check whether there is a power failure or circuits have tripped.</p>
Odor	<p>Odorous foods shall be tightly wrapped.</p> <p>Check whether there is any rotten food.</p> <p>Clean the inside of the refrigerator.</p>
Long-time operation of the compressor	<p>Long operation of the refrigerator is normal in summer when the ambient temperature is high.</p> <p>It is not recommended to have too much food in the appliance at the same time.</p> <p>Food shall get cool before being put into the appliance.</p> <p>The doors are opened too frequently.</p>
Light fails to get lit	<p>Check whether the refrigerator is connected to the power supply and whether the light is damaged.</p>
Doors cannot be properly closed	<p>The door is stuck by food packages.</p> <p>The refrigerator is tilted.</p>
Loud noise	<p>Check whether the floor is level and whether the refrigerator is placed level.</p> <p>Check whether accessories are placed at proper locations.</p>
Door seal fails to be tight	<p>Clean and remove foreign matters on the door seal.</p>
Water pan overflows	<p>There is too much food in the refrigerator, or the food stored contains too much water, resulting in heavy defrosting.</p> <p>The doors are not closed properly, resulting in frosting due to entry of air and increased water due to defrosting.</p>
Hot housing	<p>Heat dissipation of the built-in condenser via the housing, which is normal.</p> <p>When the housing becomes hot due to high ambient temperature and storage of too much food, it is recommended to provide ventilation to facilitate heat dissipation.</p>
Surface condensation	<p>Condensation on the exterior surface and door seals of the refrigerator is normal when the ambient humidity is too high. Just wipe the condensate with a clean towel.</p>
Abnormal noise	<p>Buzz: The compressor may produce buzzes during operation, and the buzzes are loud particularly upon start or stop. This is normal.</p> <p>Creak: Refrigerant flowing inside of the appliance may produce creak, which is normal.</p>