

CB2485U

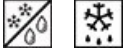

| | |
|------------------------|---|
| Product family | Refrigerator |
| Installation | Built-in |
| Category | Bottom mount |
| No-frost system | Total |
| Cooling type | Fan-assisted refrigerator, no-frost freezer |
| Defrost | Automatic |
| Hinge | Door-to-door |
| Hinge position | Right |
| Reversible door | Yes |
| EAN code | 8017709306045 |



Aesthetic



| | | | |
|---------------------------------|--------------|----------------------------------|----------|
| Material | Steel | Glass shelf profile color | Silver |
| Side material | Steel | Display | LED |
| Logo | Silkscreened | Display position | Internal |
| Door shelf profile color | Silver | | |

Refrigerator compartment features



| | | | |
|---|-------|------------------------------------|-----|
| No. of adjustable shelves | 3 | Low temperature compartment | Yes |
| Number of fruit and vegetables drawers | 2 | Refrigerator lighting | Yes |
| Type of adjustable shelves | Glass | Refrigerator lighting | LED |
| Crisper cover | Yes | | |

Refrigerator Inner Door

| | | | |
|--|---|------------------------------|---|
| Number of adjustable door shelves | 2 | No. of bottle shelves | 1 |
|--|---|------------------------------|---|

Other Refrigerator features



| | | | |
|-------------|----------|-----|-----|
| Accessories | Egg tray | Fan | Yes |
|-------------|----------|-----|-----|

Freezer features

| | |
|-------------------|---|
| Number of drawers | 3 |
|-------------------|---|

Other Freezer features



| | | | |
|-------------|-------------|---------------------------|-----|
| Accessories | 1 x ice box | Fast-freezing compartment | Yes |
|-------------|-------------|---------------------------|-----|

Other technical features



| | |
|--------------------------|---|
| Display functions | Holiday, Fast-freezing, Fast-cooling, ECO |
| Fast-freezing button | Yes |
| Power-on light | Yes |
| Door open alarm | Yes |
| Temperature setting type | Electronic |
| No. of compressors | 1 |
| Refrigerant gas type | R600a |
| Foam agent | Cyclopentane |

Performance / Energy Label NEW







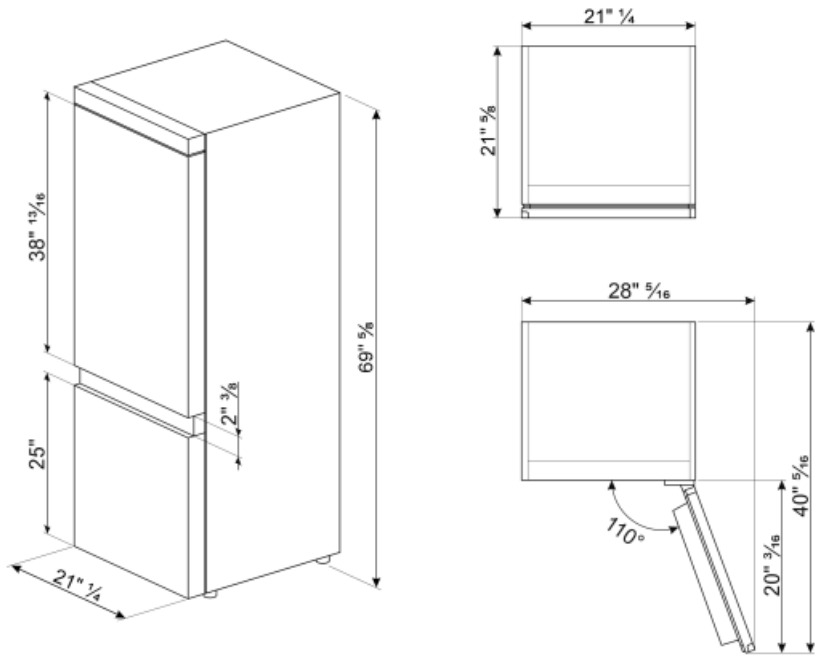

| | |
|-------------|------------------|
| Noise level | 40 dB(A) re 1 pW |
|-------------|------------------|

Electrical Connection

| | | | |
|------------------------------|------------------|-------------------|----------|
| Plug | (A) USA & Mexico | Voltage (V) | 115 V |
| Electrical connection rating | 160 W | Frequency (Hz) | 60 Hz |
| Current | 0,4 A | Power cord length | 70 7/8 " |



Symbols glossary (TT)

| | | | |
|--|--|---|--|
|  | The automatic defrost system works by automatically defrosting at regular intervals eliminating the need to defrost altogether. |  | LED display: to show programmes, functions and options selected and the time to the end of the cycle. |
|  | Economical mode: Analyzes fridge functioning during the activation and optimizes the operating cycle in order to reduce power consumption. |  | Ventilated: Forced distribution of cold air in the refrigerator compartment, which allows even temperature distribution within the fridge. |
|  | Fast freezing: The fast freezing function brings the temperature of the compartment down when activated a few hours prior to usage. |  | Power saving mode: The power saving mode allows you to disable the refrigerator and keep the freezer working. |
|  | LED interior lighting: is a more energy efficient and long lasting way of illuminating the interior of the appliance. |  | No Frost: The No Frost and Frost free systems prevent ice from forming so that no defrosting is required. |