

RSDU30R



Product family	Refrigerator
Installation	Built-in
Category	Single door
Built-in niche	>200
Reference width	70 - 80
Reference height	Higher than 200
No-frost system	Yes
Cooling type	Total no-frost - Dual-flow cooling system
Defrost	Automatic
Hinge	Door-to-door
Kitchen panel	Not supplied
Hinge position	Right
EAN code	8017709332747



Aesthetic

Aesthetics	Universal	Drawers profile color	Silver
Material	Metal	Glass shelf profile color	Silver
Logo color	Silver	Display	TFT
Side material	Steel	Display position	Internal
Logo	Silkscreened	Water filter	Yes
Door shelf profile color	Silver		

Refrigerator compartment features



No. of adjustable shelves	3	Crisper cover	Yes
Number of fruit and vegetables drawers	3	Type of crisper cover	Glass
Type of adjustable shelves	Glass	Refrigerator lighting	Yes
Crisper drawer type	Sliding crisper	Refrigerator lighting	LED

Refrigerator Inner Door

Number of adjustable door shelves	3	Adjustable door bins with wire support	Yes
-----------------------------------	---	--	-----

Other Refrigerator features



MultiFlow

Yes

Other technical features



Display functions

Holiday, Fast-cooling, Temperature alarm, Showroom mode, Sabbath

Door open alarm

Yes

Temperature Alarm

Yes

Temperature setting type

Electronic

No. of compressors

2

Refrigerant gas type

R600a

Compressor type

Inverter

Refrigerant quantity

3.0 oz

Performance / Energy Label NEW

Annual energy consumption

343 KWh/year

Climatic class

SN, N, ST, T

Total volume

17.45 cu. ft.

Electrical Connection

Plug

(B) USA 120V

Frequency (Hz)

60 Hz

Current

2.5 A

Power cord length





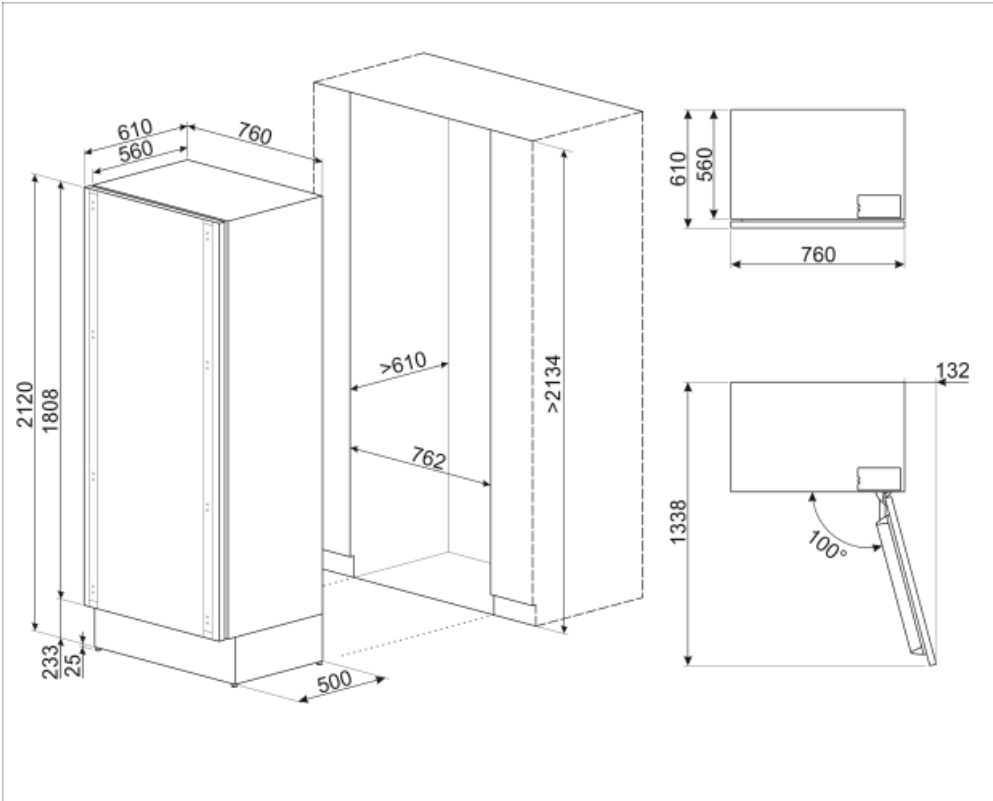

78 3/4 "

Voltage (V)

115 V



Symbols glossary (TT)

- | | | | |
|--|---|---|---|
|  | The automatic defrost system works by automatically defrosting at regular intervals eliminating the need to defrost altogether. |  | Power saving mode: The power saving mode allows you to disable the refrigerator and keep the freezer working. |
|  | LED interior lighting: is a more energy efficient and long lasting way of illuminating the interior of the appliance. |  | Inverter technology: The evolution of Smeg's driers towards more intelligent and environmentally sustainable models has led to the choice of using Inverter technology with heat pumps, which reduces significantly energy consumption. |
|  | Air plus: keeps food fresher for longer. |  | Sabbath: This function allows you to cook food during the Sabbath, the Holiday of rest in the Jewish religion, respecting the precepts. The oven works |