

# 24" MULTIFUNCTION OVEN









CODE ID

700 SERIES OVEN

**F7SM24S1**



-  TFT Display
-  Automatic Cooking
-  Defrost
-  Keep Warm Function
-  Cool Touch Door
-  Fast Pre-Heat
-  Interior Lighting

## SPECIFICATIONS

### OVEN

Full Touch Controls  
Display TFT 3,5"  
Demo Mode  
Chromed Racks  
Door Cooling System  
Event Logs (for Service)  
Black Interior  
Setting Temperature °C/°F  
Setting Weight Kg/lb  
Brightness Setting (ON condition)  
Brightness Setting (OFF condition)  
Beeper Volume Setting

### OVEN FEATURES

Defrost  
Dehydrate  
Keep Warm  
Keep Warm +  
Bottom Bake  
Bake  
Eco Bake  
Ring Convection Bake  
Convection Down + Ring  
Convection Bake  
Broil Levels  
Convection Down Bake  
Convection Broil & Bottom  
Convection Broil  
Boost (fast preheat)  
Internal Lighting



This product meets ADA (Americans with Disabilities Act) requirements. Please check with your local municipality's codes and stipulations for additional details to ensure compliance.

# DISTINTO

## 24" MULTIFUNCTION OVEN

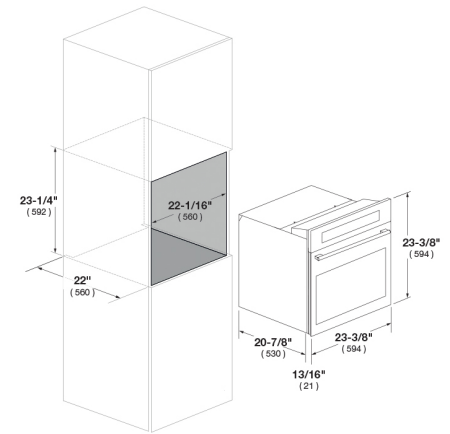

CODE ID	24" MULTIFUNCTION OVEN F7SM24S1
Type	TRADITIONAL
Size	24"
Colour	INOX
Oven Type	Multifunction (True Euro Conv.)
Temperature Regulation	Electronic
<b>CONTROL PANEL</b>	
Control type	MODULAR - Electronic
Display	TFT 3,5"
Menu Recipes	•
Commands	Full Touch - (one board 9 keys)
Language	12
<b>SPECIAL FEATURES</b>	
Demo Mode	•
Brightness setting (ON condition)	•
Brightness setting (OFF condition)	•
Beeper volume setting	•
Date format	•
Child Door Lock	-
Sabbath mode	-
12/24 hours clock format	•
kg/lb weight unit	•
°C/°F degree unit	•
Door micro switch	•
Event logs (for Service)	•
<b>OVEN DOOR(S)</b>	
Oven Glass Window	Panoramic Glass
Door Cooling System	3 Pane Heat Resistant Glass
Door Hinges	Heavy Duty Steady Tilt
Handle style	Tubular Steel
<b>OVEN CAVITY</b>	
Total Capacity ( lt )	66,8
Total Capacity ( cu. ft. )	2,36
Cavity Enameling Colour	Black
Rack Positions	5
Oven Lights	1 x 20W Halogen
Broil Upper Heating Element	1200 W (240V)
Upper Heating Element	1000W (240V)
Concealed Bake Lower Heating Element	1100 W (240V)
Convection Element Wattage	2300W (240V)
<b>OVEN ACCESSORIES</b>	
Chromed racks	•
Enameled Grill set ( basin + anti splash )	-
Telescopic chromed rack	-
Meat probe	-
<b>DIMENSIONS/WEIGHT - (IN OR LBS)</b>	
Overall dim - width	23 3/8" (594mm)
Overall dim - height	23 3/8" (594mm)
Overall dim - depth	21 7/8" (556mm)
Cutout - width	22 1/16" (560mm)
Cutout - height (min)	23 3/8" (595mm)
Cutout - depth (min)	22 1/16" (560mm)
<b>POWER / RATINGS</b>	
KW/Amps rating at 120/240V, 60Hz	3.45kW - 14.3Amps
KW/Amps rating at 120/208V, 60Hz	2.59kW - 12.4Amps
Cable + Conduit	•
<b>INSTRUCTIONS FOR USE</b>	
Instruction Manual	EN, FR