

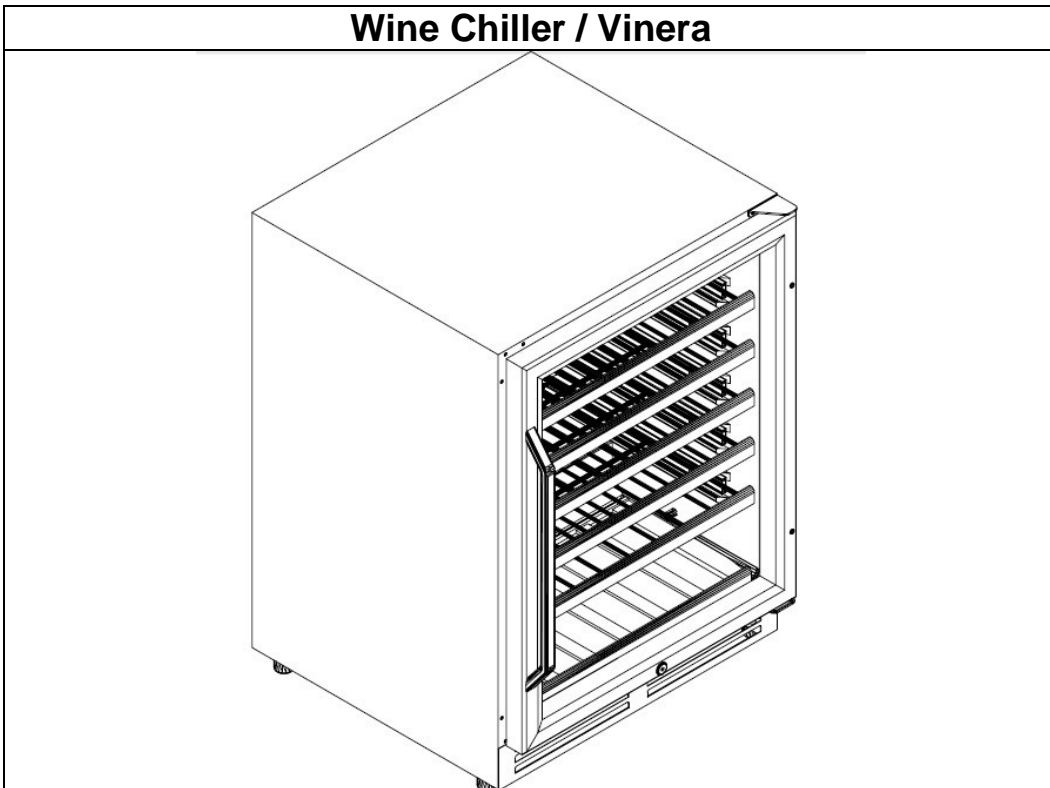

**INSTRUCTION MANUAL
MANUAL DE INSTRUCCIONES**

Model Number / No. de Modelo: WCR506SS

Wine Chiller / Vinera



BEFORE USE, PLEASE READ AND FOLLOW ALL SAFETY RULES AND OPERATING INSTRUCTIONS.

La sección en español empieza en la página 16.

Avanti Products has a policy of continuous improvement on its products and reserves the right to change materials and specifications without notice.

Avanti Products LLC
P.O. Box 520604 - Miami, Florida 33152
www.avantiproducts.com

TABLE OF CONTENTS

Important Safety Instructions	3
Appliance Safety	3
Important Safeguides	4
Refrigerant Gas Warnings	5
Help Us Help You ...	6
Parts and Features	7
Electrical Connection	8
Extension Cord / Surge Protector	8
Installation Instructions	9
Before Using Your Appliance	9
Installation of Your Appliance	9
Built-in Cabinet Instructions	9
Operating Your Appliance	
ON/OFF Power	
Setting the Temperature Control	
Storage	10 - 11
Interior Light	
Door Lock	
Shelves	
Pull-out Roller Shelves	
Care and Maintenance	12
Cleaning Your Wine Chiller	12
Power Failure	12
Moving Your Wine Chiller	12
Energy Saving Tips	12
Charcoal Filtration System	12
Troubleshooting Guide	13
Service for Your Appliance	14
Wiring Diagram	14
Your Avanti Products Warranty	15
Instrucciones en Español	16 - 18
Registration Information and Registration Card	Last Page

IMPORTANT SAFETY INSTRUCTIONS

	To reduce the risk of fire, electrical shock, or injury when using your appliance, follow these basic precautions:
<ul style="list-style-type: none">• Read all instructions before using the Wine Chiller.• DANGER or WARNING: Risk of child entrapment. Child entrapment and suffocation are not problems of the past. Junked or abandoned appliances are still dangerous . . . even if they will “just sit in the garage a few days”.• Before you throw away your old Wine Chiller: Take off the door. Leave the shelves in place so that children may not easily climb inside.• Never allow children to operate, play with, or crawl inside the appliance.• Never clean appliance parts with flammable fluids. The fumes can create a fire hazard or explosion.• Do not store or use gasoline or any other flammable vapors and liquids in the vicinity of this or any other appliance. The fumes can create a fire hazard or explosion. <p style="text-align: center;">-Save these instructions-</p>	

APPLIANCE SAFETY

Your safety and the safety of others are very important.

We have provided many important safety messages in this manual and on your appliance. Always read and obey all safety messages.



This is the Safety Alert Symbol. This symbol alerts you to potential hazards that can kill or injure you and others. All safety messages will follow the Safety Alert Symbol and either the words “DANGER”, “WARNING” or “CAUTION”.



Danger means that failure to heed this safety statement may result in severe personal injury or death.



Warning means that failure to heed this safety statement may result in extensive product damage, serious personal injury, or death.



Caution means that failure to heed this safety statement may result in minor or moderate personal injury, or property or equipment damage.

All safety messages will alert you do what the potential hazard is, tell you how to reduce the chance of injury, and let you know what can happen if the instructions are not followed.

IMPORTANT SAFEGUIDES



Before the appliance is used, it must be properly positioned and installed as described in this manual, so read the manual carefully. To reduce the risk of fire, electrical shock or injury when using the appliance, follow basic precaution, including the following:

DANGER

- Plug into a grounded 3-prong outlet, do not remove grounding prong, do not use an adapter, and do not use an extension cord.
- Replace all panels before operating.
- It is recommended that a separate circuit, serving only your appliance be provided. Use receptacles that cannot be turned off by a switch or pull chain.
- Never clean appliance parts with flammable fluids. These fumes can create a fire hazard or explosion. And do not store or use gasoline or other flammable vapors and liquids in the vicinity of this or any other appliance. The fumes can create a fire hazard or explosion.
- Before proceeding with cleaning and maintenance operations, make sure the power line of the unit is disconnected.
- Do not connect or disconnect the electric plug when your hands are wet.
- Unplug the appliance or disconnect power before cleaning or servicing. Failure to do so can result in electrical shock or death.
- Do not attempt to repair or replace any part of your appliance unless it is specifically recommended in this material. All other servicing should be referred to a qualified technician.

WARNING

FOLLOW WARNING CALL OUTS BELOW ONLY WHEN APPLICABLE TO YOUR MODEL

- Use two or more people to move and install appliance. Failure to do so can result in back or other injury.
- To ensure proper ventilation for your appliance, the front of the unit must be completely unobstructed. Choose a well-ventilated area with temperatures above 60°F (16°C) and below 90°F (32°C). This unit must be installed in an area protected from the element, such as wind, rain, water spray or drips.
- The appliance should not be located next to ovens, grills or other sources of high heat.
- The appliance must be installed with all electrical, water and drain connections in accordance with state and local codes. A standard electrical supply (115 V AC only, 60 Hz), properly grounded in accordance with the National Electrical Code and local codes and ordinances is required.
- Do not kink or pinch the power supply cord of appliance.
- The fuse (or circuit breaker) size should be 15 amperes.
- It is important for the appliance to be leveled in order to work properly. You may need to make several adjustments to level it.
- Never allow children to operate, play with or crawl inside the appliance.
- Do not use solvent-based cleaning agents or abrasives on the interior. These cleaners may damage or discolor the interior.
- Do not use this apparatus for other than its intended purpose.

REFRIGERANT GAS WARNINGS / AVERTISSEMENTS GAZ REFRIGERANT

DANGER - Risk of fire or explosion. Flammable refrigerant used.

DO NOT use mechanical devices to defrost refrigerator. DO NOT puncture refrigerant tubing.

DANGER - Risque d'incendie ou d'explosion. Réfrigérant inflammable utilisé.

Ne pas utiliser de dispositifs mécaniques pour réfrigérateur à dégivrage. Ne pas percer la tuyauterie du réfrigérant

DANGER - Risk of fire or explosion. Flammable refrigerant used.

To be repaired only by trained service personnel. DO NOT puncture refrigerant tubing.

DANGER - Risque d'incendie ou d'explosion. Réfrigérant inflammable utilisé.

Pour être réparé que par du personnel qualifié. Ne pas percer la tuyauterie du réfrigérant.

CAUTION - Risk of fire or explosion. Flammable refrigerant used.

Consult repair manual / owner's guide before attempting to service this product. All safety precautions must be followed.

AVERTISSEMENT - Risque d'incendie ou d'explosion. Réfrigérant inflammable utilisé. Consultez réparation manuelle / propriétaire, guide avant d'essayer de réparer ce produit. Toutes les précautions doivent être suivies.

CAUTION - Risk of fire or explosion. Dispose of property in accordance with federal or local regulations. Flammable refrigerant used.

AVERTISSEMENT - Risque d'incendie ou d'explosion. Aliéner des biens

conformément à la réglementation fédérale ou locale. Réfrigérant inflammable utilisé.

CAUTION - Risk of fire or explosion due to puncture of refrigerant tubing;

Follow handling instructions carefully. Flammable refrigerant used.

AVERTISSEMENT - Risque d'incendie ou d'explosion dus à la perforation des tuyaux de fluide réfrigérant, suivez attentivement les instructions remises. Réfrigérant inflammable utilisé

CAUTION-To Prevent A Child From Being Entrapped, Keep Out Of Reach Of Children And Not In The Vicinity Of Freezer (Or Refrigerator).



CAUTION-Risk of Fire



HELP US HELP YOU...

Read this guide carefully.

It is intended to help you operate and maintain your new Wine Chiller properly.

Keep it handy to answer your questions. If you don't understand something or you need more assistance, please call:

Avanti Customer Service
800-220-5570

Keep proof of original purchase date (such as your sales slip) with this guide to establish the warranty period.

CAUTION:

THIS WINE CHILLER IS NOT DESIGNED FOR THE STORAGE OF MEDICINE OR OTHER MEDICAL PRODUCTS.

Write down the model and serial numbers.

You'll find them on a plate located on the rear outside wall of the Wine Chiller.

Please write these numbers here:

Date of Purchase

Model Number

Serial Number

Use these numbers in any correspondence or service calls concerning your Wine Chiller.

If you received a damaged Wine Chiller, immediately contact the dealer (or builder) that sold you the Wine Chiller.

Save time and money. Before you call for service, check the Troubleshooting Guide. It lists causes of minor operating problems that you can correct yourself.

IF YOU NEED SERVICE

We're proud of our service and want you to be pleased. If for some reason you are not happy with the service you receive, here are some steps to follow for further assistance.

FIRST, contact the people who serviced your Wine Chiller. Explain why you are not pleased. In most cases, this will solve the problem.

NEXT, if you are still not pleased, write all the details, including your telephone number, and send it to:

Customer Service
Avanti Products
10880 NW 30 Street
Miami, FL 33172 USA

PARTS & FEATURES

WCR506SS – Wine Chiller

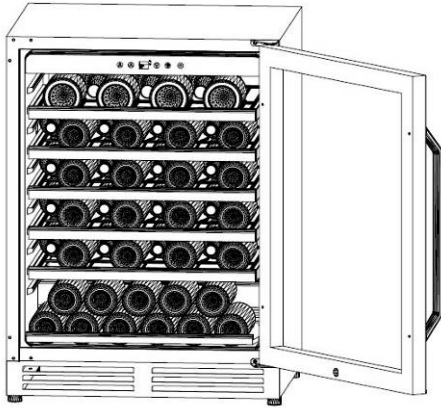

1	Interior Fan
2	Charcoal Filter
3	Control Panel
4	Stainless Steel Handle
5	Glass Door with Stainless Steel Frame
6	Leveling Leg
7	Front Grille
8	Roll-out Shelves (50% Roll-out)
9	Short shelf
10	Security Lock (Not Shown – Front of Door)

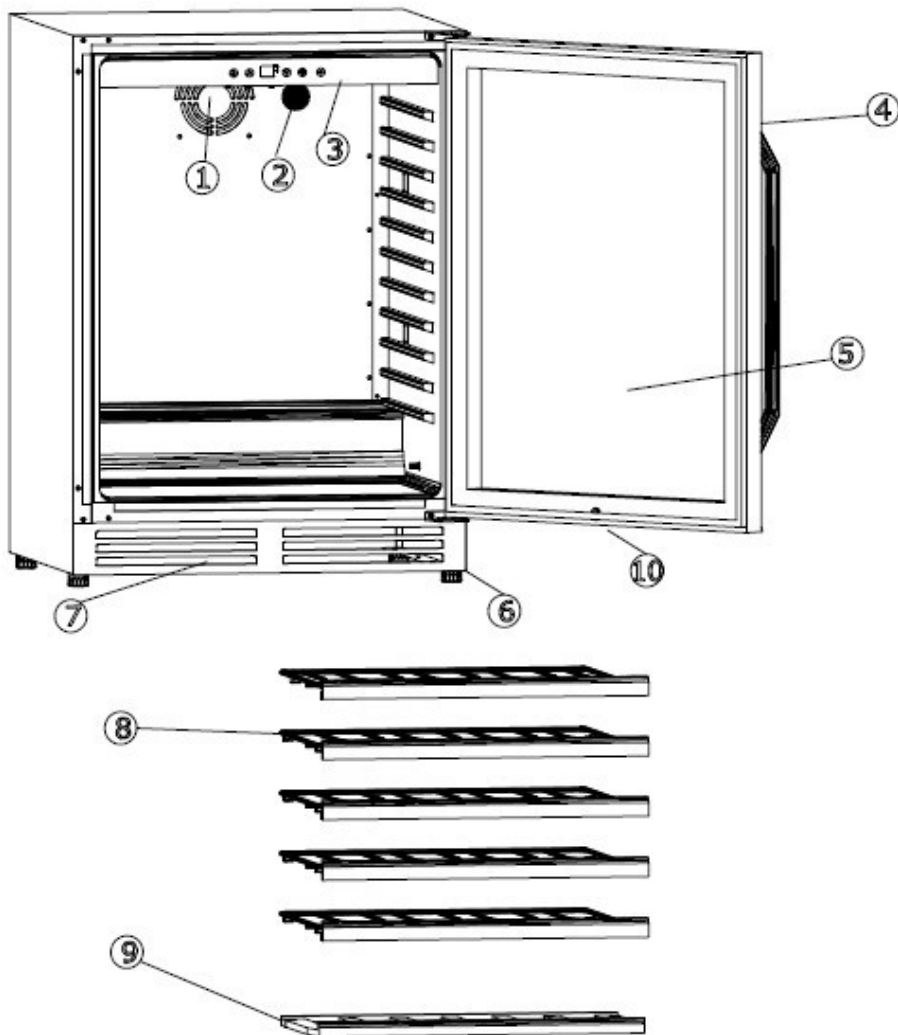

ELECTRICAL CONNECTION

⚡ Warning ⚡

Improper use of the grounded plug can result in the risk of electrical shock. If the power cord is damaged, have it replaced by an authorized Avanti Products service center.

This appliance should be properly grounded for your safety. The power cord of this appliance is equipped with a three-prong plug which mates with standard three prong wall outlets to minimize the possibility of electrical shock.

Do not under any circumstances cut or remove the third ground prong from the power cord supplied. For personal safety, this appliance must be properly grounded.

This appliance requires a standard 115/120 Volt AC ~/60Hz electrical ground outlet with three-prong. Have the wall outlet and circuit checked by a qualified electrician to make sure the outlet is properly grounded. When a standard 2-prong wall outlet is encountered, it is your responsibility and obligation to have it replaced with a properly grounded 3-prong wall outlet.

The cord should be secured behind the appliance and not left exposed or dangling to prevent accidental injury.

The appliance should always be plugged into its own individual electrical outlet which has a voltage rating that matches the rating label on the appliance. This provides the best performance and also prevent overloading house wiring circuits that could cause a fire hazard from overheated. Never unplug the appliance by pulling the power cord. Always grip the plug firmly and pull straight out from the receptacle. Repair or replace immediately all power cords that have become frayed or otherwise damaged. Do not use a cord that shows cracks or abrasion damage along its length or at either end. When moving the appliance, be careful not to damage the power cord.

➤ **EXTENSION CORD**

Because of potential safety hazards under certain conditions, it is strongly recommended that you do not use an extension cord with this appliance. However, if you must use an extension cord it is absolutely necessary that it be a UL/CUL-Listed, 3-wire grounding type appliance extension cord having a grounding type plug and outlet and that the electrical rating of the cord be 115 volts and at least 10 amperes.

➤ **SURGE PROTECTOR**

Most electrical appliances use a series of electric control boards to operate. These boards are very susceptible to power surges and could be damaged or destroyed.

If the appliance is going to be used in an area or if your city / country is prone to power surges / outages; it is suggested that you use a power surge protector for all electrical devices / appliances you use. The surge protector that you select must have a surge block high enough to protect the appliance it is connected to. If you have any questions regarding the type and size of surge protector needed contact a licensed electrician in your area.

Damages due to power surges are not considered a manufacturer covered defect and will void your product warranty.

INSTALLATION INSTRUCTIONS

➤ **BEFORE USING YOUR WINE CHILLER**

- Remove the exterior and interior packing.
- Check to be sure you have all of the following parts:

1	Instruction Manual
5	Large Shelves
1	Short Shelf
2	Keys
1 Set	Stainless Steel Hinges for Door Swing Reversal
2	Hinge Screw Caps
1	Stainless Steel Handle

- Before connecting this appliance to the power source, let it stand upright for approximately 2 hours. This will reduce the possibility of a malfunction in the cooling system from handling during transportation.
- Clean the interior surface with lukewarm water using a soft cloth.

➤ **INSTALLATION OF YOUR WINE CHILLER**

- This appliance is designed to be for free standing installation or built-in (fully recessed).
- Place your Wine Chiller on a floor that is strong enough to support it when it is fully loaded. To level your Wine Chiller, adjust the front leveling legs at the bottom of the Wine Chiller.
- Locate the Wine Chiller away from direct sunlight and sources of heat (stove, heater, radiator, etc.). Direct sunlight may affect the acrylic coating and heat sources may increase electrical consumption. Extreme cold ambient temperatures may also cause the unit not to perform properly.
- Avoid locating the unit in moist areas.
- Plug the Wine Chiller into an exclusive, properly installed-grounded wall outlet. Do not under any circumstances cut or remove the third (ground) prong from the power cord. Any questions concerning power and/or grounding should be directed toward a certified electrician or an authorized Avanti Products service center.

➤ **BUILT – IN CABINET INSTRUCTIONS**

This unit is designed for both built-in or free standing installation. If you plan to use this unit in a built-in application please follow the requirements shown to the right.

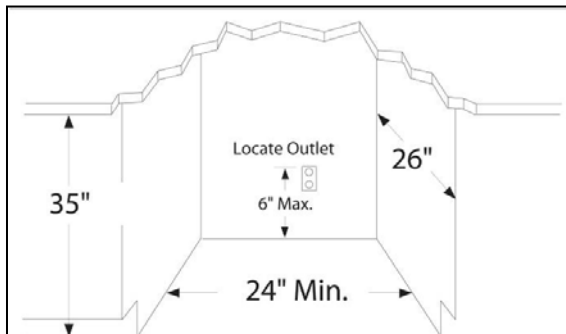

← Figure shown		
Cabinet Opening Dimensions		
	IN (min)	MM (min)
Width	24"	610 mm
Depth	26"	661 mm
Height	35"	889 mm

Figure shown →		
Unit Dimensions		
	IN (min)	MM (min)
Width	23 ² / ₅ "	595 mm
Depth (with handle)	24 ² / ₅ "	620 mm
Depth (without handle)	22 ³ / ₄ "	575 mm
Height	34 ¹ / ₄ "	870 mm

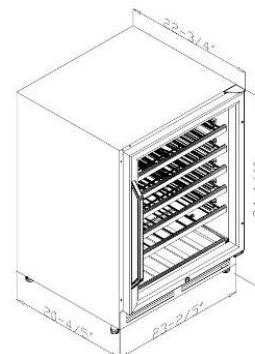

OPERATING YOUR WINE CHILLER

It is recommended you install the appliance in a place where the ambient temperature is between 72-78 degrees Fahrenheit. If the ambient temperature is above or below recommended temperatures, the performance of the unit may be affected. For example, placing your unit in extreme cold or hot conditions may cause interior temperatures to fluctuate. The range of 40-65 degrees Fahrenheit may not be reached. Your wine chiller is designed to operate with at a range of 40° - 65° F (5 – 18°C).

Recommended Temperatures for Chilling Wine.

Red Wines	58 - 65 °F	14 - 18 °C		Rose Wines	49 - 51 °F	9 - 11 °C
Dry / White Wines	48 - 57 °F	10 - 13 °C		Sparkling Wines	40 - 47 °F	5 - 8 °C

Wine Chiller Control Panel

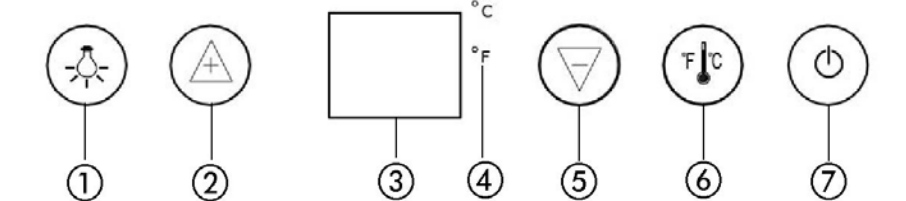



1	Interior Light ON/OFF Button	5	Temperature DOWN Button
2	Temperature UP Button	6	°F/°C Selector Button
3	Electronic Display	7	Power Button
4	°F/°C Indicator Light		

You can select temperature display setting from Fahrenheit to Celsius degree by pushing the **°F/°C** button/mark. Fahrenheit or Celsius degrees indicator will appear in green color in the temperature display window.



➤ ON/OFF POWER

To turn ON or OFF the appliance, press the  button/mark and hold for **3** seconds.

➤ SETTING THE TEMPERATURE CONTROL

You can press  and  buttons/marks to control the internal temperature .

The degrees indicators will appear in the display window.

- The temperature that you desire to set will increase 1°F or 1°C if you push the  button/mark once, on the contrary the temperature will decrease 1°F or 1°C if you push the  button/mark once.

NOTE:

- If the unit is unplugged, power lost, or turned off, you must wait 3 to 5 minutes before restarting the unit. If you attempt to restart before this time delay, the Wine Chiller will not start.
- When you use the wine chiller for the first time or restart the wine chiller after having been shut off for a long time, there could be a few degrees variance between the temperature you select and the one indicated on the LED readout. This is normal and it is due to the length of the activation time. Once the wine chiller is running for a few hours everything will be back to normal.

➤ STORAGE

Many bottles may differ in size and dimensions. As such the actual number of bottles you may be able to store may vary.

NOTE: Capacity:

Bottle capacities are approximate maximums when storing traditional Bordeaux 750 ML bottles and include bulk storage.

➤ **INTERIOR LIGHT**

- You can turn the interior light on or off by pushing the button marked 

➤ **DOOR LOCK**

Your unit is provided with a lock and key combination.

The keys are located inside the plastic bag that contains the User's Guide. Insert the key into the lock and turn it counterclockwise to **unlock** the door. To lock the door do the reverse operation making sure metal pin is engaged completely. Remove the key and place it in a secure place for safekeeping.

➤ **SHELVES**

The appliance is equipped with the wired shelves.

You can move the shelves out and in smoothly.

- To prevent damaging the door gasket, make sure to have the door all the way opened when pulling the bottom shelf out of the rail compartment.
- For easy access to the storage content, you can pull the shelf approximately 50% out of the rail compartment, however this unit was designed with a stopper on each side of the shelf track to prevent bottles from falling.
- When removing the shelf out of the inner rail, make sure to remove all items first. Then pull the shelf until it is stopped by the stopper, and then lift the shelf. In order to replace the shelf, repeat steps described above in reverse.



PULL-OUT ROLLER SHELVES

- To prevent damaging the door gasket, make sure to have the door all the way opened when pulling shelves out of the rail compartment.
- For easy access to the bottles, you must pull the shelves approximately 1/3 out of the rail compartment.

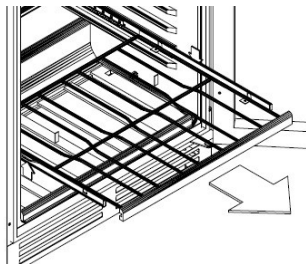

- To remove the shelves out of the rail pull each shelf approximately 1/3 out. Use a long flat screwdriver to press down the right plastic notch as shown in Figure A and at the same time lift the left plastic notch as shown in Figure B. Then proceed to pull out the shelf slowly. Contact our service department if assistance is needed.

Figure A

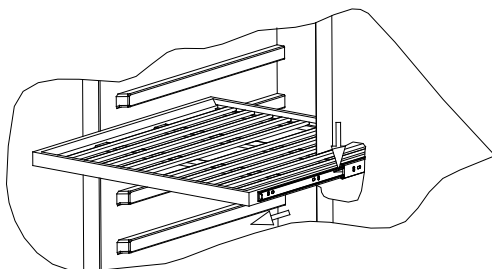
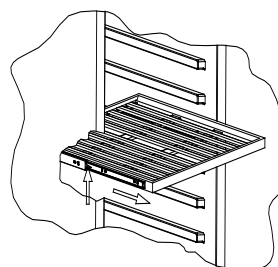

Figure B



CARE AND MAINTENANCE

➤ CLEANING YOUR WINE CHILLER

- Turn off the power, unplug the appliance, and remove all items including shelves.
- Wash the inside surfaces with a warm water and baking soda solution. The solution should be about 2 tablespoons of baking soda to a quart of water.
- Wash the shelves with a mild detergent solution.
- Wring excess water out of the sponge or cloth when cleaning area of the controls, or any electrical parts.
- Wash the outside cabinet with warm water and mild liquid detergent. Rinse well and wipe dry with a clean soft cloth.
- Do not use steel wool or steel brush on the stainless steel. These will contaminate the stainless steel with steel particles and rusting may occur.

➤ POWER FAILURE

- Most power failures are corrected within a few hours and should not affect the temperature of your appliance if you minimize the number of times the door is opened. If the power is going to be off for a longer period of time, you need to take the proper steps to protect your contents.

➤ MOVING YOUR WINE CHILLER

- Remove all items.
- Securely tape down all loose items (shelves) inside your appliance.
- Tape the door shut.
- Be sure the appliance stays secure in the upright position during transportation. Also protect outside of appliance with a blanket, or similar item.

➤ ENERGY SAVING TIPS

- The Wine Chiller should be located in the coolest area of the room, away from heat producing appliances, and out of the direct sunlight.

CHARCOAL FILTRATION SYSTEM

Your wine is a living object that breathes through the cork of its bottle. In order to preserve the quality and taste of your fine wines, they must be stored at the ideal temperature and ambient conditions.

Your cellar is equipped with an active charcoal filtration system to ensure air purity, cooling efficiency, and to maintain an odor free cabinet for the storage of your fine wines. The filter assembly is located at the rear panel inside your cellar.

Keep in mind, that this filter must be changed every 12 months.

To purchase replacement filters, call our Parts / Service Department at 1 – 800 – 220 – 5570.

To replace your filter:

1	Remove the bottles of wine stored on the two (2) shelves in front of the filter.
2	Remove the shelves and set aside to be replaced once you have changed the filter
3	Hold the filter and turn it at 45 degrees in the counter-clockwise direction and then pull it out.
4	Remove the existing filter and replace with a new one.
5	Put the new filter into the hole and then turn the filter at 45 degrees in clockwise direction.

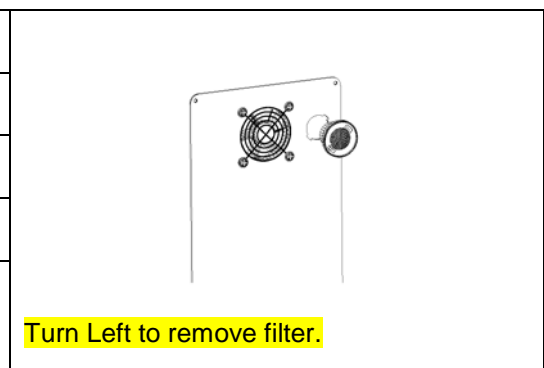

PROBLEMS WITH YOUR WINE CHILLER?

You can solve many common Wine Chiller problems easily, saving you the cost of a possible service call. Try the suggestions below to see if you can solve the problem before calling the servicer.

TROUBLESHOOTING GUIDE

PROBLEM	POSSIBLE CAUSE
Wine Chiller does not operate.	Not plugged in. The appliance is turned off. The circuit breaker tripped or a blown fuse.
Wine Chiller is not cold enough.	Check the temperature control setting. The door is opened too often. The door is not closed completely. The door gasket does not seal properly.
Turns on and off frequently.	The room temperature is hotter than normal. A large amount of contents has been added to the wine chiller. The door is opened too often. The door is not closed completely. The temperature control is not set correctly. The door gasket does not seal properly.
The light does not work.	Not plugged in. The circuit breaker tripped or a blown fuse. The light button is turned off.
Vibrations.	Check to assure that the Wine Chiller is level.
The Wine Chiller seems to make too much noise.	The rattling noise may come from the flow of the refrigerant, which is normal. As each cycle ends, you may hear gurgling sounds caused by the flow of refrigerant in your Wine Chiller. Contraction and expansion of the inside walls may cause popping and crackling noises. The Wine Chiller is not level.
The door will not close properly.	The door is misaligned. The Wine Chiller is not level. The gasket is dirty. The shelves are out of position.
Display flashes Error message "E1"	Temperature sensor failure. Contact the Avanti Service Department – 1 - 800 – 220 - 5570
Display flashes Error message "E2"	Defrost sensor (Coil Sensor) failure. Contact the Avanti Service Department – 1 - 800 – 220 – 5570

SERVICE FOR YOUR WINE CHILLER

We are proud of our customer service organization and the network of professional service technicians that provide service on your Avanti appliances. With the purchase of your Avanti appliance, you can have the confidence that if you ever need additional information or assistance, the Avanti Products Customer Service team will be here for you. Just call us toll-free.

AVANTI PRODUCTS CUSTOMER SERVICES

Product Information 800-323-5029	Whatever your questions are about our products, help is available.
Part Orders 800-220-5570	You may order parts and accessories that will be delivered directly to your home by personal check, money order, Master Card, or Visa.
In-Home Repair Service 800-220-5570	An Avanti Products authorized service center will provide expert repair service, scheduled at a time that is convenient for you. Our trained servicers know your appliance inside and out.

WIRING DIAGRAM

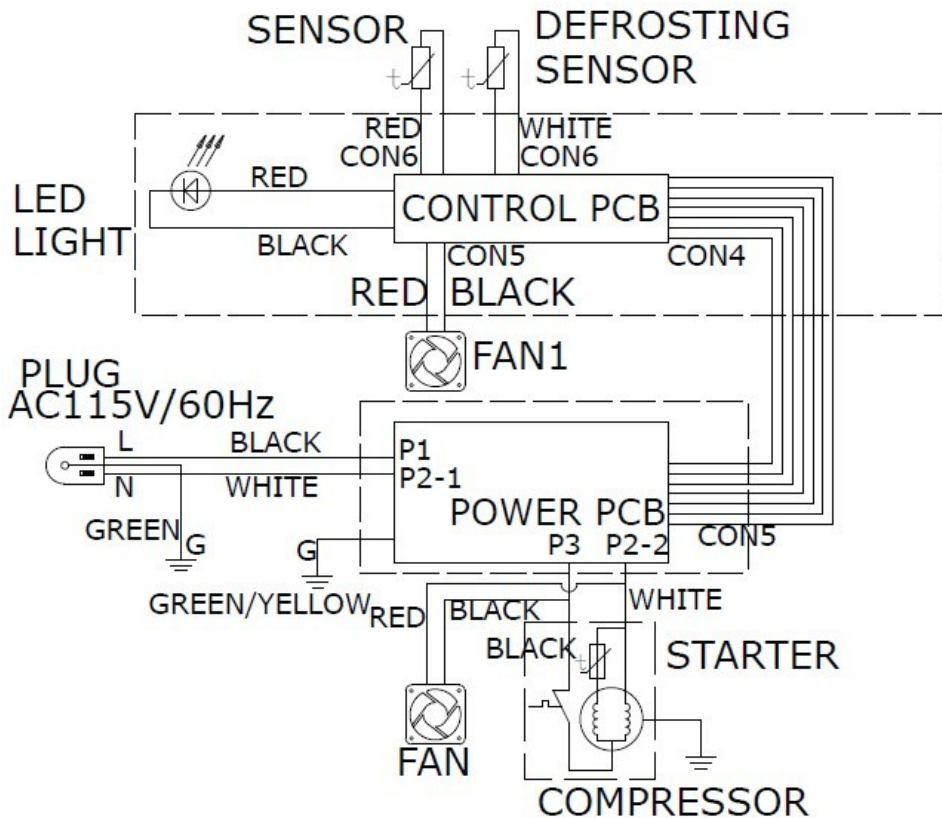

YOUR AVANTI PRODUCTS WARRANTY	Staple your sales receipt here. Proof of original purchase date is needed to obtain service under warranty.
<u>WHAT IS COVERED – LIMITED ONE-YEAR WARRANTY</u>	
Avanti Products warrants that the product is free from defects in materials and/or workmanship for a period of twelve (12) months from the date of purchase by the original owner. The foregoing timeline begins to run upon the date of purchase, and shall not be stalled, tolled, extended, or suspended for any reason whatsoever unless described in detail in the warranty document. For one year from the date of purchase by the original owner, Avanti products will, at its option, repair or replace any part of the product which proves to be defective in material or workmanship under normal use. Avanti Products will provide you with a reasonably similar product that is either new or factory refurbished. During this period Avanti Products will provide all parts and labor necessary to correct such defects free of charge, so long as the product has been installed and operated in accordance with the written instructions in this manual. In rental or commercial use, the warranty period is 90 days. All Avanti appliances of 3.5 cubic feet capacity or less must be brought/sent to the appliance service center for repair.	
<u>LIMITED SECOND THROUGH FIFTH YEAR WARRANTY</u>	
For the second through the fifth year from the date of original purchase, Avanti Products will provide a replacement compressor free of charge due to a failure. You are responsible for the service labor and freight charges. In rental or commercial use, the limited compressor warranty is one year and nine months. Costs involved to move the product to the service center and back to the user's home, as maybe required, are the user's responsibility.	
<u>WARRANTY EXCLUSIONS / WHAT IS NOT COVERED:</u>	
The warranty coverage described herein excludes all defects or damage that are not the direct fault of Avanti Products, including without limitation, one or more of the following:	
<ul style="list-style-type: none"> ● A failure to comply with any applicable state, local, city, or county electrical, plumbing and/or building codes, regulations, or laws, including failure to install the product in strict conformity with local fire and building codes and regulations. ● Any external, elemental and/or environmental forces and factors, including without limitation, rain, wind, sand, floods, fires, mud slides, freezing temperatures, excessive moisture or extended exposure to humidity, lightning, power surges, structural failures surrounding the appliance, and acts of God. 	
<ul style="list-style-type: none"> ● Content losses of food or other content due to spoilage. ● Incidental or consequential damages ● Parts and labor costs for the following will not be considered as warranty: <ul style="list-style-type: none"> ● Light bulbs and/or plastic housing. ● Plastic cabinet liners. ● Punctured evaporator that voids the warranty on the complete sealed system. 	<ul style="list-style-type: none"> ● Shipping and handling costs associated with the replacement of the unit. ● Repairs performed by unauthorized servicers. ● Service calls that are related to external problems, such as abuse, misuse, inadequate electrical power, accidents, fire, floods, or any other acts of God. ● Failure of the product if it is used for other than its intended purpose. ● The warranty does not apply outside the Continental USA. ● Surcharges including but not limited to, any after hour, weekend, or holiday service calls, tolls, ferry trip charges, or mileage expense for service calls to remote areas.
In no event shall Avanti Products have any liability or responsibility whatsoever for damage to surrounding property, including cabinetry, floors, ceilings, and other structures and/or objects around the product. Also excluded from this warranty are scratches, nicks, minor dents, and other cosmetic damages on external surfaces and exposed parts; Products on which the serial numbers have been altered, defaced or removed; service visits for customer education, or visits where there is nothing wrong with the product; correction of installation problems (you are solely responsible for any structure and setting for the product, including all electrical, plumbing and/or other connecting facilities, for proper foundation/flooring, and for any alterations including without limitation cabinetry, walls, floors, shelving etc., as well as the resetting of breakers or fuses.	
<u>OUT OF WARRANTY PRODUCT</u>	
Avanti Products is under no obligation, at law or otherwise, to provide you with any concessions, including repairs, pro-rates, or product replacement, once this warranty has expired.	

WARRANTY – REFRIGERATION - COMPRESSOR

INSTRUCCIONES DE SEGURIDAD

ATENCION

INSTRUCCIONES PARA LA CONEXION A TIERRA

Este aparato electrodoméstico debe estar conectado a tierra. En caso de un cortocircuito eléctrico, la conexión a tierra reduce el riesgo de choque eléctrico proporcionando un cable a tierra con una enchufe de conexión a tierra. Este enchufe debe estar conectado en un tomacorriente instalado correctamente y conectado a tierra.

ADVERTENCIA – El uso inadecuado del enchufe de conexión a tierra puede resultar en un riesgo de choque eléctrico. Consulte con un electricista o persona de reparaciones competente si no comprenden bien las instrucciones de conexión a tierra o si existe alguna duda sobre si el aparato esta conectado a tierra correctamente.

NO USE UN CORDON DE PROLONGACION ELECTRICA

Use un tomacorriente de pared exclusivo. No conecte su vinera a cordones de prolongación eléctrica o junto a cualquier otro electrodoméstico en el mismo tomacorriente de pared.

ADVERTENCIA IMPORTANTE:

Una vinera vacía es una atracción muy peligrosa para los niños. Saque todas las juntas, pestillos, tapas o puerta de todo electrodoméstico que no esté en uso, o tome alguna medida para asegurar que no presente peligro.

INSTRUCCIONES DE INSTALACION

Saque los embalajes exteriores, limpie bien el exterior con un paño suave seco, y el interior con un paño húmedo y tibio. Evite colocar la vinera cerca de una fuente de calor, luz de sol directa, o lugar húmedo.

Ubicación

1. Seleccione un lugar con su piso fuerte y nivelado.
2. Evite la luz directa del sol o calor. La luz directa del sol puede afectar la capa de acrílico. Las fuentes de calor en su proximidad provocarán un consumo mayor de electricidad.

OPERACION

Para evitar vibraciones, la unidad debe estar bien nivelada. La temperatura variará dependiendo de la cantidad de botellas almacenadas y la frecuencia con que se abre la puerta.

Cuando la vinera no se use por un período largo, desconecte el enchufe y deje la puerta entreabierta.

Nota: Espere entre 3 a 5 minutos antes de volver a encender si el funcionamiento ha sido interrumpido.

Se recomienda que Ud coloque su vinera en un lugar donde la temperatura ambiental se mantenga entre 23-25 grados centígrados.

Si la temperatura ambiental oscila afuera de esos límites, pueda afectar la temperatura de la caja. Por ejemplo, si su unidad está situada en lugares donde hay temperaturas muy frías o calientes también puede afectar la temperatura de la caja.

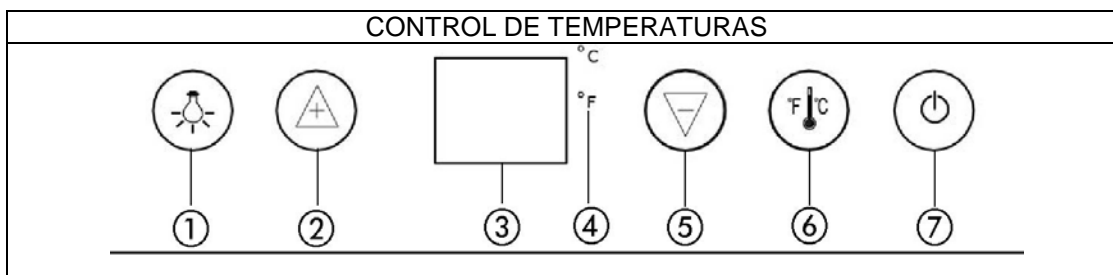

Temperaturas recomendadas para enfriar vinos:

Vinos tintos	14° - 18° C	58 – 65° F
Vinos blanco/seco	10° - 13° C	48 – 57° F
Vinos rosé/Zinfandel	9° - 11° C	49 – 51° F
Vinos blanco/espumante	5° - 8° C	40 – 47° F









ENCENDIDO/APAGADO

Para apagar el refrigerador de vino, presione el botón () y manténgalo oprimido por un mínimo de 3 segundos.

 Ud. puede seleccionar los grados centígrados o Fahrenheit presionando el botón marcado . En la pantalla digital aparecerá el F o C indicador en color verde.

Operación

Oprima los botones marcado "  " y "  " localizados en el panel de controles para programar la temperatura. Al oprimir los botones marcados "  " o "  " por primera vez, el indicador en la pantalla mostrará la temperatura programada de fábrica o la más reciente.

Oprima el botón marcado () una vez y la temperatura aumentará un grado. Si Ud oprime el botón marcado () una vez la temperatura bajará un grado.

Luz interior

La luz interior se controla manualmente y no funciona al abrir ni cerrar la puerta. Para prender o apagar la luz, presione el boton marcado () de la luz ubicado en el panel de control.

Cerradura de la puerta

Su unidad viene equipada con una combinación de cerradura y llave.

Las llaves (2) están dentro de la bolsa plástica junto al manual de instrucciones.

Introduzca la llave en la cerradura y gírela hacia la izquierda para abrir la puerta.

Para cerrarla, gire la llave hacia la derecha.

Quite la llave y colóquela en un lugar seguro para evitar que se pierda.

Descongelación

Su vinera ha sido diseñada con un sistema de descongelación de “ciclo automático”.

Las superficies refrigeradas del compartimiento para vinos se descongela automáticamente, durante el ciclo “apagado” del control de enfriamiento (termostato). El agua descongelada del compartimiento es eliminada automáticamente, encauzándola hacia una bandeja de goteo ubicada en el compresor. La transferencia de calor del compresor evapora el agua.

ADVERTENCIA

Asegúrese de tener la puerta abierta completamente si Ud desea remover las repisas o moverlas hacia adelante para extraer una botella.

CUIDADO Y MANTENIMIENTO

Limpieza

Para limpiar el interior, use un paño suave con una solución de una cucharada de bicarbonato de sodio por cada cuarto de agua, o una solución de espuma de jabón suave, o un detergente suave. Para lavar las rejillas, sáquelas deslizándolas con cuidado, y use una solución de detergente suave; luego séquelas con un paño suave. Limpie el exterior con un paño húmedo suave y un poco de detergente suave o productos de limpieza para electrodomésticos.

Período de vacaciones

Para períodos cortos de vacaciones, deje los controles en la posición normal. Durante ausencias más largas;

- (a) saque todas las botellas,
- (b) desconecte la vinera del tomacorriente,
- (c) limpie bien el refrigerador para vinos,
- (d) deje la puerta abierta para evitar la formación de condensación, moho u olores.

Corte de corriente

La mayoría de los cortes de corriente se corrigen en una o dos horas y no afectarán las temperaturas de su vinera. Sin embargo, Ud. deberá reducir la cantidad de veces que abra la puerta cuando la corriente esté apagada.

Si Ud. se muda

Saque o asegure todos los artículos dentro de su vinera. Para evitar que los tornillos nivelantes se averíen, gírelos completamente hacia la base.

Algunas reglas importantes para el uso correcto de la vinera.

- Las bebidas se deben guardar en botellas cerradas.
- No sobrecargue el compartimiento interior.
- No abra la puerta a menos que sea necesario.
- Si la vinera se guardará sin uso por períodos largos, se sugiere que, luego de una limpieza cuidadosa, se deje la puerta entreabierta para permitir que el aire circule dentro de la caja y evitar una posible formación de condensación, moho u olores.
- Nunca cubra los estantes del compartimiento para vinos con papel de aluminio o cualquier otro material para cubrir estantes que puedan obstruir la circulación del aire.

Registration Information

Thank you for purchasing this fine Avanti product. Please fill out this form and return it to the following address within 100 days from the date of purchase and receive these important benefits:

Avanti Products LLC
P.O.Box 520604 – Miami, Florida 33152

➤ **Protect your product:**

We will keep the model number and date of purchase of your new Avanti product on file to help you refer to this information in the event of an insurance claim such as fire or theft.

➤ **Promote better products:**

We value your input. Your responses will help us develop products designed to best meet your future needs.

------(detach here)-----

Avanti Registration Card

Name			Model #	Serial #
Address			Date Purchased	Store / Dealer Name
City	State	Zip	E-mail Address	
Area Code	Phone Number		Occupation	
Did You Purchase An Additional Warranty			As your Primary Residence, Do You:	
<input type="checkbox"/> Extended			<input type="checkbox"/> Own	
<input type="checkbox"/> None			<input type="checkbox"/> Rent	
Reason for Choosing This Avanti Product: Please indicate the most important factors That influenced your decision to purchase this product:			Your Age:	
<input type="checkbox"/> Price			<input type="checkbox"/> under 18	
<input type="checkbox"/> Product Features			<input type="checkbox"/> 18-25	
<input type="checkbox"/> Avanti Reputation			<input type="checkbox"/> 26-30	
<input type="checkbox"/> Product Quality			<input type="checkbox"/> 31-35	
<input type="checkbox"/> Salesperson Recommendation			<input type="checkbox"/> 36-50	
<input type="checkbox"/> Other: _____			<input type="checkbox"/> over 50	
<input type="checkbox"/> Friend / Relative Recommendation			<u>Marital Status:</u>	
<input type="checkbox"/> Warranty			<input type="checkbox"/> Married	
<input type="checkbox"/> Other: _____			<input type="checkbox"/> Single	
Comments:			<u>Is This Product Used In The:</u>	
			<input type="checkbox"/> Home	
			<input type="checkbox"/> Business	
			<u>How Did You Learn About This Product:</u>	
			<input type="checkbox"/> Advertising	
			<input type="checkbox"/> In-Store Demo	
			<input type="checkbox"/> Personal Demo	

WCR506SS – 09042013 Revised

PRINTED IN CHINA