

PTW805BPWRS

GE Profile™ 5.3 cu. ft. Capacity Washer with Smarter Wash Technology and Adaptive SmartDispense™

DIMENSIONS AND INSTALLATION INFORMATION (IN INCHES)

CIRCUIT REQUIREMENTS: An individual, properly-grounded branch circuit, with a three-prong grounding-type receptacle, protected by a 15 or 20 amp circuit breaker or a time-delay fuse, is required.

ELECTRICAL RATING: 120V, 60Hz, 10A

NOTE: Washer wall outlet must be located within 36" of service code entry. Wall outlet must not be located behind dryer.

INSTALLATION INFORMATION: Before installing, consult installation instructions packed with product for current dimensional data.

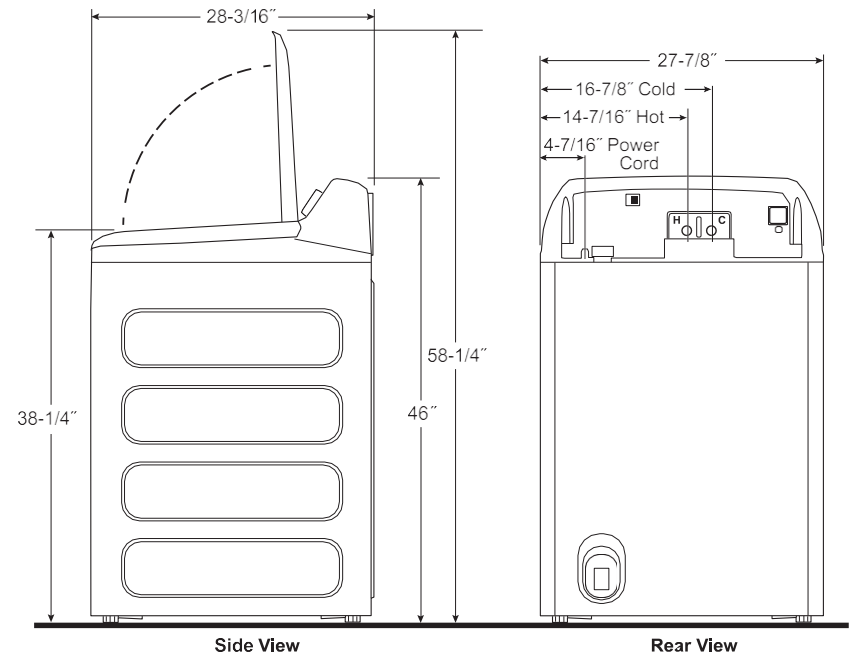

For answers to your Monogram, Café™, GE Profile™ or GE Appliances product questions, visit our website at geappliances.com or call GE Answer Center® Service, 800.626.2000.



Specification Revised 7/13/24

PTW805BPWRS

GE Profile™ 5.3 cu. ft. Capacity Washer with Smarter Wash Technology and Adaptive SmartDispense™

FEATURES AND BENEFITS

Adaptive SmartDispense™ Technology – Save time and effort with a dispenser that holds enough detergent for up to 32 loads. Plus, scan the barcode on the detergent bottle with the SmartHQ™ app and the washer will dispense the right amount based on the type of detergent.

Smart Wash & Smart Rinse – Sensors measure soil and detergent levels throughout the cycle and during the rinse to optimize wash and rinse times, deliver better fabric care and ensure a thorough clean.

Enhanced Smarter Wash Technology – Adaptive Smarter Wash Technology enables greater optimization of cleaning power and fabric care within each cycle.

Smart FlexDispense® – Dedicated dispensers for detergent, detergent packs like Tide PODS™, fabric softener and other common additives speed up activation and optimize cleaning performance.

Power Pre-Wash – Clean even the most heavily soiled items with a single cycle that adds detergent, agitates, soaks, drains the dirty water and repeats the wash process with clean water and fresh detergent.

Microban® Antimicrobial Technology – Antimicrobial protection is built into key washer components to help prevent the growth of odor-causing bacteria in areas like the tub, dispenser drawer and drain hose.

Quiet Wash w/ dBT – The direct drive motor and patented Dynamic Balancing Technology minimizes uneven loads and provides a quieter wash.

Tangle Control – Intelligent technology adapts the wash action to minimize tangled loads.

10-year Limited Warranty – Enjoy peace of mind knowing your washer is backed by a 10-year limited warranty.

Easier Access Capacity – Enjoy large capacity and still reach the bottom of the washer with comfort and ease.

Smart Features powered by SmartHQ™ – Ensure your washer always has the latest features, including customized stain removal technology and extra cycles for active wear and casuals. Plus, easily control and monitor your laundry from anywhere, receive remote status notifications and more.

ENERGY STAR® qualified – Meets or exceeds federal guidelines for energy efficiency for year-round energy and money savings.

Model PTW805BPWRS – Sapphire Blue

