

24" Pocket Handle Dishwasher

800 Series – White SHP78CM2N

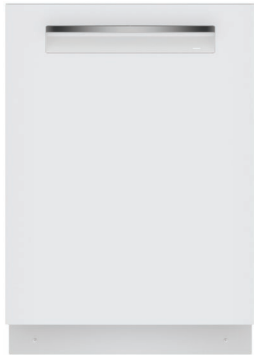

SHP78CM2N
White

Also available in:

- Stainless Steel SHP78CM5N
- Black SHP78CM6N
- Black SHP78CM4N
- Stainless

PowerControl™ spray arm targets your dirtiest dishes with a deeper clean, no matter where you load them on the bottom rack.

Features & Benefits

Patented CrystalDry™ technology transforms moisture into heat to get dishes, including plastics, 60% drier.*

The Flexible 3rd Rack with fold down sides adds 30% more* loading area, perfect for utensils and ramekins.

Enhance your cleaning experience with Wi-Fi enabled Home Connect®. Access additional wash cycles and options or choose the right one for your needs using Smart Cycle.

So quiet at 42 dBA, the InfoLight® bar shines below the handle so you know the dishwasher is running.

| General Properties | |
|----------------------------------|-----------------------------------|
| Number of wash cycles | 5 + 3 additional in Home Connect® |
| Number of options | 4 + 2 additional in Home Connect® |
| dBA | 42 |
| Wash system | PrecisionWash® with PowerControl™ |
| Drying system | CrystalDry™ |
| Third rack | Flexible 3rd Rack |
| Rack adjustability | Rackmatic® |
| Tub material | Stainless Steel |
| Control type | Touch Controls |
| Concealed water heating element | Yes |
| Leak protection system | 24/7 AquaStop® |
| Home Connect® (WiFi enabled) | Yes |
| NSF®-certified** sanitize option | Yes |
| Water softener | No |
| Five-level wash | Yes |
| Child Lock button suspension | No |
| Anti-Fingerprint Finish | N/A |
| Special features | CrystalDry™ Option, InfoLight® |
| Efficiency | |
| Water usage per cycle | 3.2 gal |
| ENERGY STAR® certified | Yes |
| Total annual energy consumption | 240 kWh |
| Capacity | |
| Number of place settings | 16 |



* Based on aggregate average drying performance of Bosch Dishwashers with CrystalDry™ on combined household load including plastics, glass, steel, and porcelain as compared to Bosch Dishwashers with PureDry®. Drying performance may vary by dish type.

**Compared to a Bosch dishwasher with 2 racks.

**Certification to NSF/ANSI Standard 184 for residential dishwashers.

| Technical Details | |
|--|---------------------------|
| Watts | 1440 W |
| Current | 12 Amps |
| Volts | 120 V |
| Frequency | 60 Hz |
| Power cord full length | 67" |
| Power cord install length from edge of unit when facing the door | Left – 45" Right – 56" |
| Minimum water pressure | 14 lb/sin |
| Length outlet hose | 78 3/4" |

Dimensions & Weight

| | |
|--------------------------------------|------------------------------|
| Overall appliance dimensions (HxWxD) | 33 7/8" x 23 9/16" x 23 3/4" |
| Required cutout size (HxWxD) | 33 7/8" x 24" x 24" |
| Adjustable feet | Yes |
| Net weight | 96 lbs |

Accessories—Optional

| | |
|--|------------|
| Junction Box | SMZPCJB1UC |
| Junction Box + Supply Hose Kit | SMZ3IN1UC |
| Supply Hose Kit with Elbow | SMZSH1ABUC |
| Drain Hose Extension Kit | SGZ1010UC |
| Dishwasher Accessory Kit | SMZ5000 |
| Flexible Silverware Basket | SMZ4000UC |
| Anti-Tarnish Silverware Cassette | SMZ5002UC |
| Edge Protector + Power Cord Clip Install Kit | SMZEPCC1UC |

Accessories: To purchase Bosch accessories, cleaners & parts please visit www.bosch-home.com/us/store or call 1-800-944-2904 (Mon to Fri 5 am to 6 pm PST, Sat 6 am to 3 pm PST).

Notes: All height, width and depth dimensions are shown in inches. BSH reserves the absolute and unrestricted right to change product materials and specifications, at any time, without notice. Consult the product's installation instructions for final dimensional data and other details prior to making cutout.

Warranties: Please see Use & Care manual or Bosch website for statement of limited warranty.

For more information on our entire line of products, go to www.bosch-home.com/us or call 1-800-944-2904

© BSH Home Appliances Corporation. All rights reserved. Bosch is a registered trademark of Robert Bosch GmbH.

24" Pocket Handle Dishwasher

800 Series – White SHP78CM2N



Installation Details

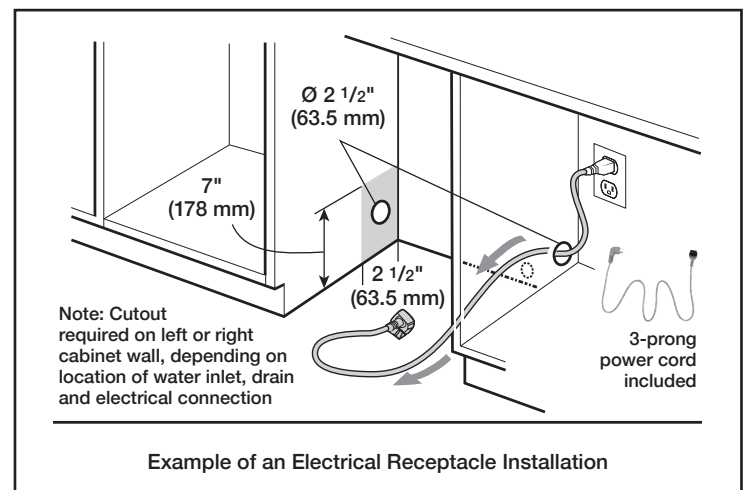
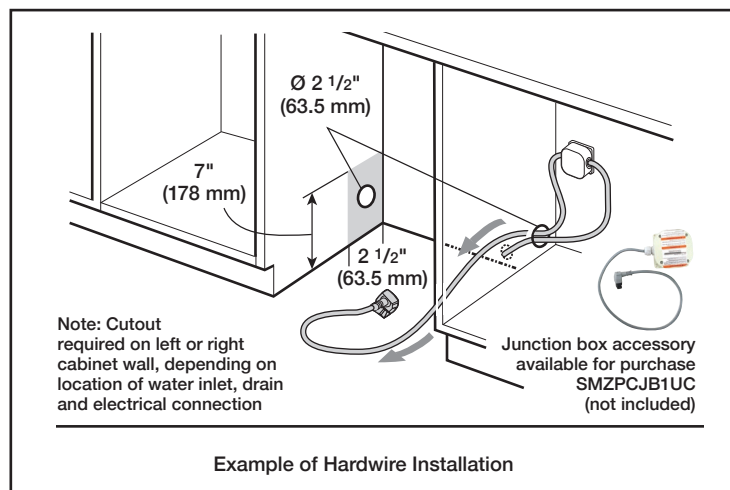
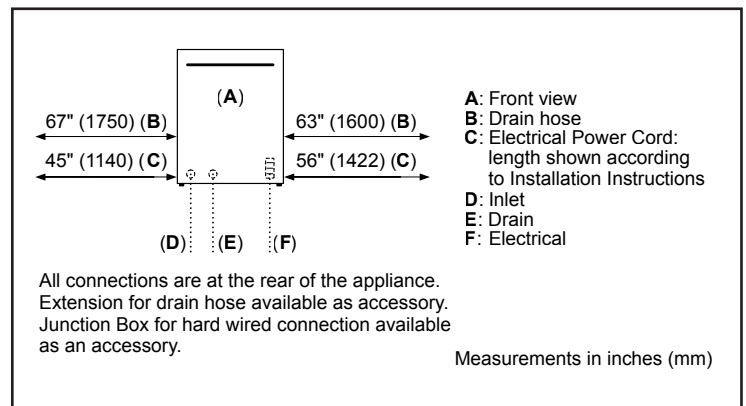
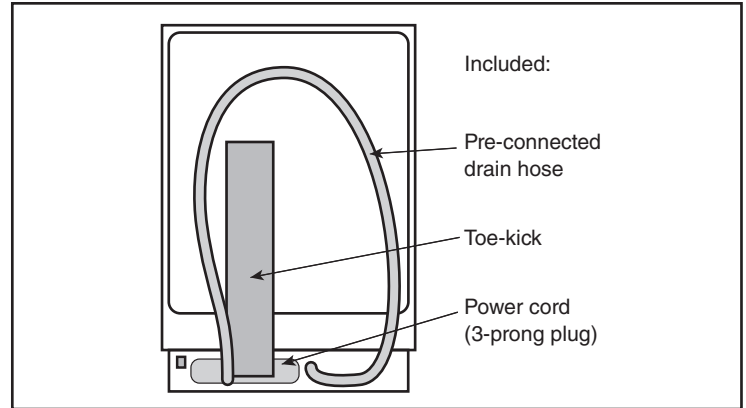
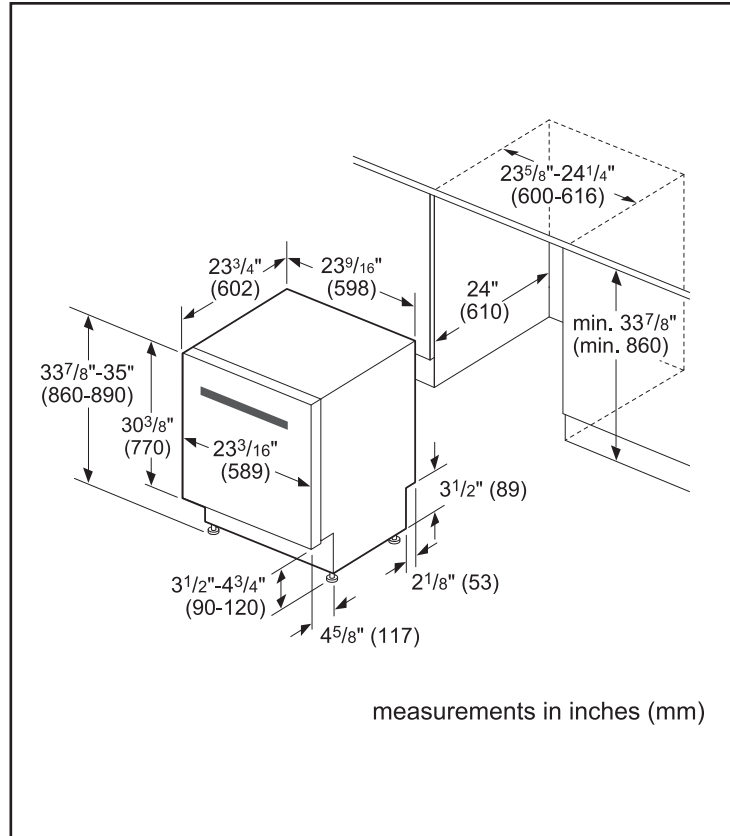

Accessories: To purchase Bosch accessories, cleaners & parts please visit www.bosch-home.com/us/store or call 1-800-944-2904 (Mon to Fri 5 am to 6 pm PST, Sat 6 am to 3 pm PST).

Notes: All height, width and depth dimensions are shown in inches. BSH reserves the absolute and unrestricted right to change product materials and specifications, at any time, without notice. Consult the product's installation instructions for final dimensional data and other details prior to making cutout.

Warranties: Please see Use & Care manual or Bosch website for statement of limited warranty.

For more information on our entire line of products, go to www.bosch-home.com/us or call 1-800-944-2904

© BSH Home Appliances Corporation. All rights reserved. Bosch is a registered trademark of Robert Bosch GmbH.

24" Pocket Handle Dishwasher

800 Series – White SHP78CM2N



BOSCH

Invented for life



Installation Details

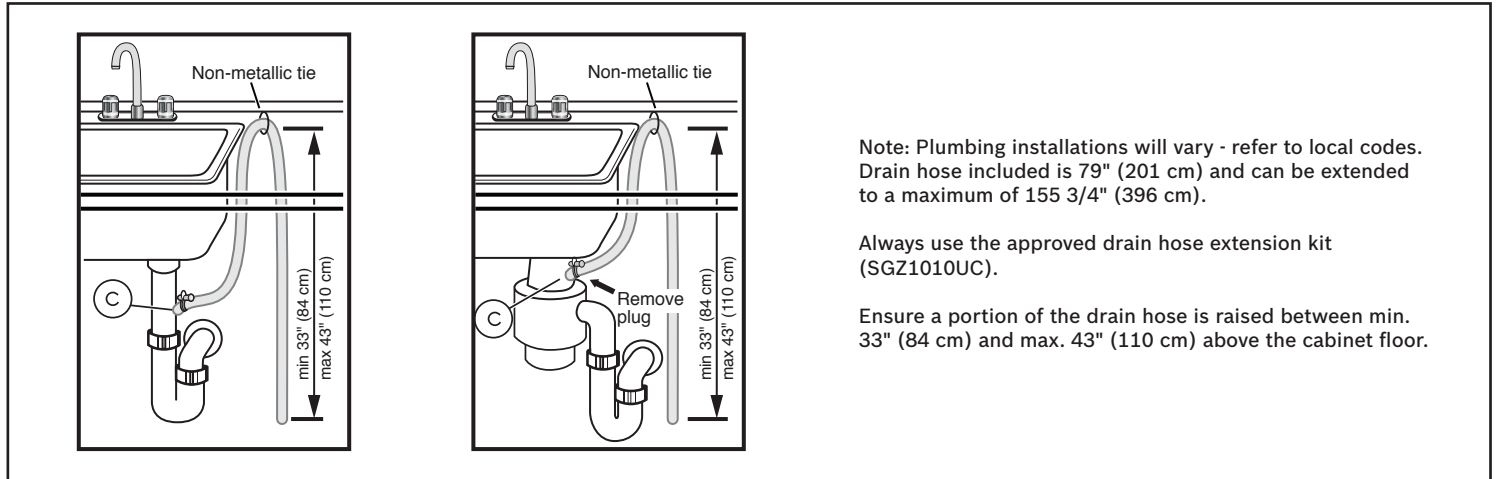

Accessories: To purchase Bosch accessories, cleaners & parts please visit www.bosch-home.com/us/store or call 1-800-944-2904 (Mon to Fri 5 am to 6 pm PST, Sat 6 am to 3 pm PST).

Notes: All height, width and depth dimensions are shown in inches. BSH reserves the absolute and unrestricted right to change product materials and specifications, at any time, without notice. Consult the product's installation instructions for final dimensional data and other details prior to making cutout.

Warranties: Please see Use & Care manual or Bosch website for statement of limited warranty.

For more information on our entire line of products, go to www.bosch-home.com/us or call 1-800-944-2904

© BSH Home Appliances Corporation. All rights reserved. Bosch is a registered trademark of Robert Bosch GmbH.