

# PRODUCT DIMENSIONS

SIDE VIEW

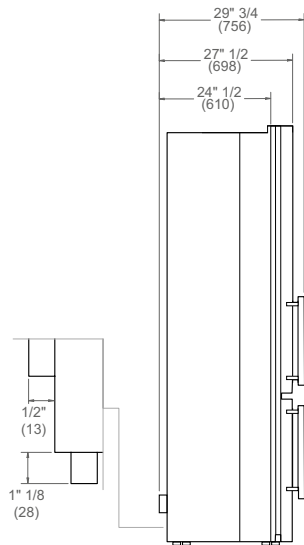

FRONT VIEW

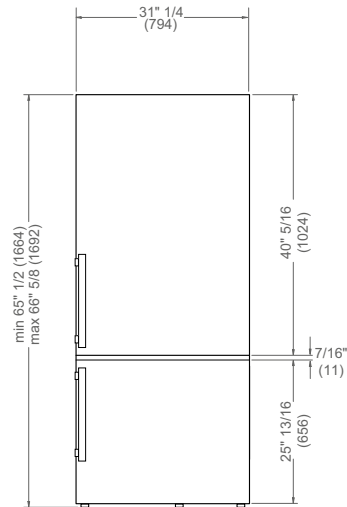

TOP VIEW

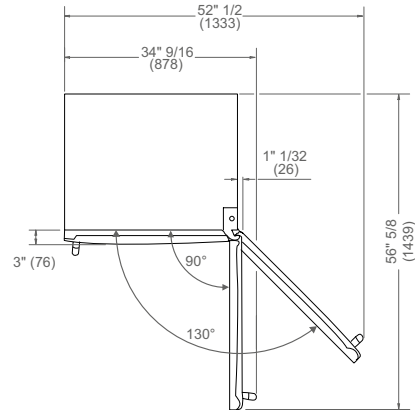

## CUTOUT DIMENSIONS (Counter-depth Installation)

SIDE VIEW

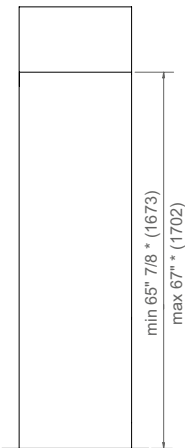

FRONT VIEW

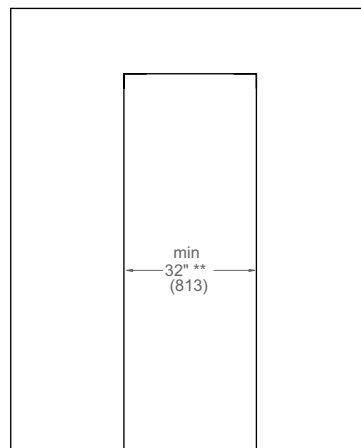

TOP VIEW

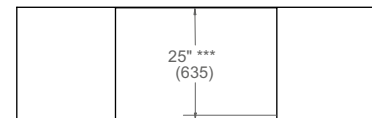

\* dimension with a minimum clearance of 3/8" (9,5 mm) on the top

\*\* dimension with a minimum clearance of 3/8" (9,5 mm) on both sides

\*\*\* dimension with a minimum clearance of 2" (50 mm) on the back

## ELECTRICAL CONNECTION



A properly-grounded, horizontally-mounted electrical receptacle should be installed according to this drawing.

Connection(s) placement within the opening may require additional cabinet depth.

TOP VIEW

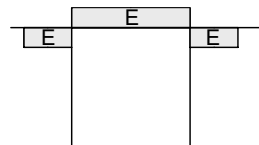

FRONT VIEW

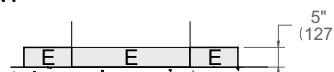

Dimensions in parentheses are millimeters unless otherwise specified.