

Blomberg®

seit 1883

Front-Loading Dryer

Owner's Guide &

Installation Instructions

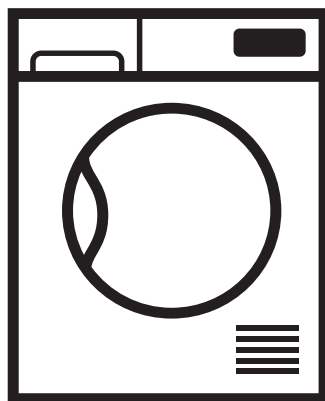

DHP 24400 W

DHP 24412 W



Read this page first.





Dear Customer,

We hope that your product, which has been manufactured in modern facilities and passed strict quality control procedures, will give you the best results. We also want to be sure that you use his dryer properly and safely. Read this entire manual before installing and operating the dryer and keep this guide for future reference.

- Keep this operating manual handy. You may need it in the future. If you sell or transfer the product to someone else, give them this manual.
- Please read all additional documentation supplied with this dryer.
- Please note that this operation manual may be applicable for several models. Differences between models will be identified in the manual.

Explanation of symbols

Throughout this Owner's guide the following symbols are used:

	Important information or useful hints about usage.
	Warning for hazardous situations with regard to life and property.
	Warning against electric shock.
	Warning against hot surfaces.
	Warning against fire hazard.
	Packaging materials of the product are manufactured from recyclable materials in accordance with our National Environment Regulations.

Do not dispose of the packaging wastes with the domestic waste or other wastes, discard them to the dedicated collection points designated by the local authorities.

TABLE OF CONTENTS

1 Your Dryer	4	5 Maintenance and cleaning	17
1.1 Overview.....	4	5.1 Control panel	17
1.2 Package Contents	5	5.2 Screen symbols.....	17
2 Important Safety Instructions	6	5.3 Preparing the dryer.....	18
3 Installation Instructions	10	5.4 Program selection.....	18
3.1 Electrical connection.....	10	5.5 Main programs.....	18
3.2 Grounding Instructions	11	5.6 Extra programs	18
3.3 Appropriate installation location.....	12	5.7 Program selection and consumption table.....	20
3.4 Minimum Installation Clearances.....	13	5.8 Auxiliary functions.....	21
3.5 Use on top of a washer.....	13	5.9 Warning symbols	21
3.6 Adjusting the feet.....	13	5.10 End duration	21
3.7 Destroying packaging material	13	5.11 Starting the program	22
3.8 Connecting to the drain	13	5.12 Child Lock.....	22
4 Preparation	15	5.13 Changing the program after it is started.....	22
4.1 Laundry suitable for drying in the dryer	15	5.14 Canceling the program	23
4.2 Laundry not suitable for drying in the dryer	15	5.15 Program end.....	23
4.3 Preparing laundry for drying	15	6 Technical Specifications	24
4.4 Things to be done for energy saving .	15	7 Maintenance and cleaning	25
4.5 Correct load capacity.....	16	7.1 Cleaning Lint Filter / Loading Door Inner Surface	25
		7.2 Cleaning the sensor.....	26
		7.3 Cleaning the filter drawer.....	26
		7.4 Cleaning the evaporator	28
		8 Troubleshooting	29
		9 Warranty Statement	31

1 Your Dryer

1.1 Overview

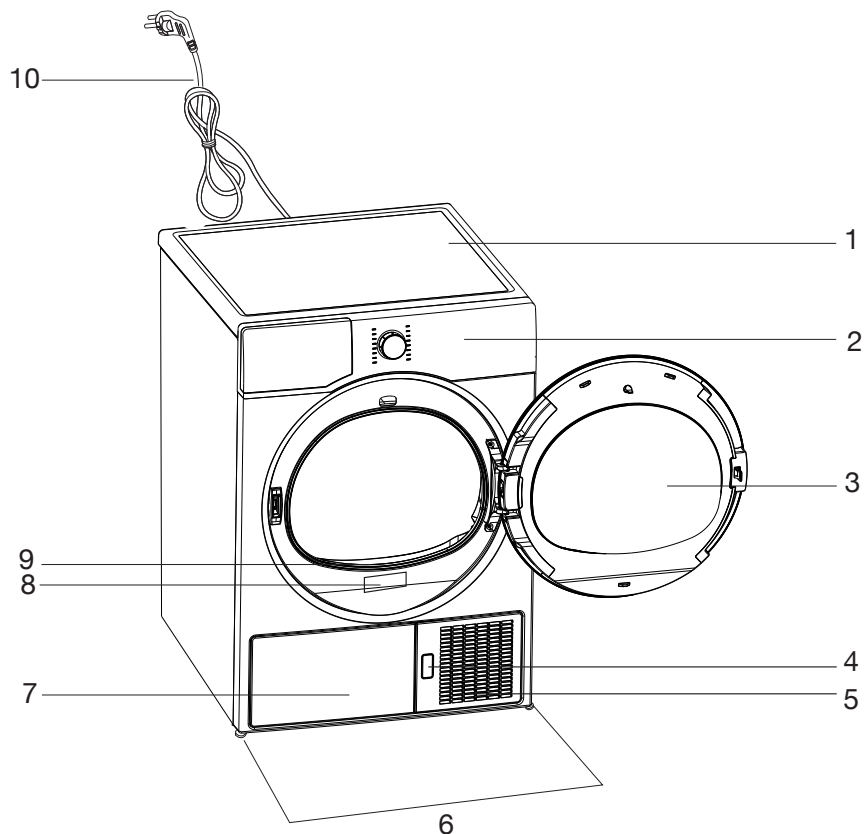

1. Top panel
2. Control panel
3. Loading door
4. Kick plate opening tab
5. Ventilation grids
6. Adjustable feet
7. Kick plate
8. Type label
9. Lint filter
10. Power cable

1.2 Package Contents

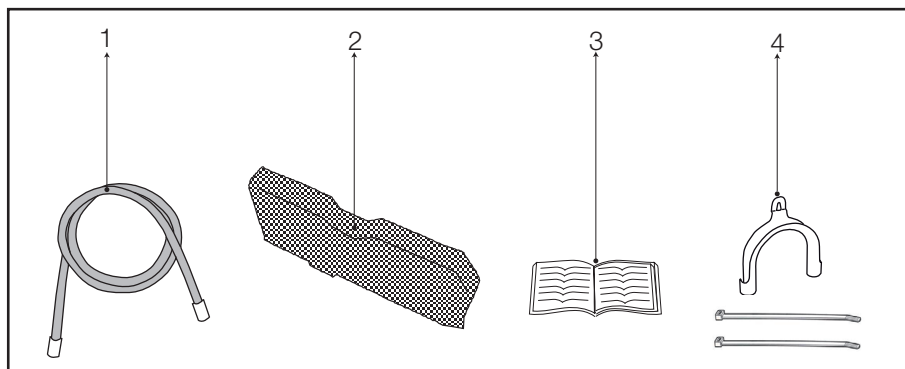

1. Water drain hose (2951261600)
2. Filter drawer spare sponge (2964840100)
3. User Manual (2960311018)
4. Drain connector (2828040100)

2 Important Safety Instructions



WARNING: To reduce the risk of fire or electric shock resulting in serious injury or death when using this appliance, follow the basic precautions including the following:

- Read all instructions before using the appliance. Failure to follow these instructions will increase the risk of fire or electric shock and will void the warranty.



This product has been designed for home use only.

- The appliance must be operated at temperatures between +5°C and +35°C. (41°F and +95°F)
- The appliance must not be installed behind a lockable door, a sliding door or a door with the hinges on the opposite side to that of the tumble dryer.
- Do not install or store this appliance where it will be exposed to weather.
- Do not tamper with the controls.
- Do not repair or replace any part of the appliance or attempt any servicing unless specifically recommended in the user-maintenance instructions or in published user-repair instructions that you understand and have the skills to carry out.
- Never wash the appliance with water.
- Never touch the plug with wet hands.
- Never pull from the cable to unplug the dryer.
- Do not operate the appliance if the power cord or plug is damaged.
- For malfunctions that cannot be solved by information in the operating manual: Turn off and unplug the appliance and call an authorized service provider.
- This appliance must be grounded. In the event of malfunction or breakdown, grounding will reduce the risk of electric shock by providing a path of least resistance

for electric current. This appliance is equipped with a cord having an equipment-grounding conductor and a grounded plug. The plug must be plugged into an appropriate outlet that is properly installed and grounded in accordance with all local codes and ordinances.



WARNING: Improper connection of the equipment-grounding conductor can result in a risk of electric shock. Check with a qualified electrician or service representative or personnel if you are in doubt as to whether the appliance is properly grounded.

- Power cord plug must be within easy reach after installation.
- To reduce the risk of fire or electric shock, do not use extension cords, multi-plugs or an adapter to connect the dryer to electrical mains.
- Do not modify the plug provided with the appliance: if it will not fit the outlet, have a proper outlet installed by a qualified electrician.
- If the power supply cord is damaged, it must be replaced by the manufacturer, its service agent or similarly qualified persons in order to avoid an electrical hazard.
- The appliance must not be operated unless it is repaired!
- Ventilation openings in the base must not be obstructed by carpets, etc.
- Exhaust air must not be discharged into a flue used for exhausting fumes from appliances burning gas or other fuels.
- Adequate ventilation must be provided to avoid the back flow of gases into the room from appliances burning other fuels, including open fires.
- Do not dry articles that have been previously cleaned in, washed in, soaked in or spotted with gasoline, dry-cleaning solvents or other flammable or explosive substances as they give off vapors that could ignite or explode.

- Do not use the tumble dryer if industrial chemicals have been used for cleaning what you want to dry.
- Do not dry unwashed items in the tumble dryer.
- Items such as foam rubber (latex foam), shower caps, waterproof textiles, rubber-backed articles and clothes or pillows fitted with foam rubber pads should not be dried in the tumble dryer.
- Do not use fabric softeners or products to eliminate static unless recommended by the manufacturer of the fabric softener or product.
- The appliance may only be used for the drying of textiles that are marked accordingly.
- Undergarments that contain metal reinforcements should not be placed in a tumble dryer. Damage to the tumble dryer can result if any of the metal reinforcement come loose during drying.
- Before loading check all garments for lighters, coins, metal pieces, needles, etc.
- The use of fabric softener sheets is not recommended.
- Do not place items exposed to cooking oils in your dryer. Items contaminated with cooking oils may contribute to a chemical reaction that could cause a load to catch fire. To reduce the risk of fire due to contaminated loads, the final part of a tumble dryer cycle occurs without heat (cool down period). Avoid stopping a tumble dryer before the end of the drying cycle unless all items are quickly removed and spread out so that the heat is dissipated.



WARNING: Never stop the tumble dryer before the end of the drying cycle unless all items are quickly removed and spread out to dissipate heat.

- Do not reach into the appliance if the drum is moving.
- Do not allow children to play on or in the appliance. Close supervision of children is necessary when the appliance is used near children.

- Keep pets away from the appliance during the drying cycle.
- Before the appliance is removed from service or discarded, remove the door to the drying compartment.
- Close the loading door when you leave the area where the dryer is located.
- This appliance is not intended for use by persons (including children) with reduced physical, sensory or mental capabilities, or lack of experience and knowledge, unless they are supervised or have been given instructions concerning the use of the appliance by a person responsible for their safety.
- Clean lint filter before or after each load.
- Keep area around the exhaust vent and adjacent surrounding areas free from the accumulation of lint, dust, and dirt.
- The interior of the appliance and exhaust ductwork should be cleaned periodically by qualified service personnel.
- Never use the dryer without the lint filter.
- When your dryer is not in use or after the laundry is taken out following the completion of drying process, turn off by using the On/Off button. In cases when the On/Off button is in the On position while the dryer is plugged in, keep the door of the dryer closed.
- For power saving in models with lamps, when your dryer is not in use, keep the door closed if the On/Off button is in the On position and the dryer is energized.



WARNING: This product can expose you to chemicals including Nickel (Metallic) which is known to the State of California to cause cancer. For more information go to www.P65Warnings.ca.gov
Note : Nickel is a component in all stainless steel and some other metal components.

SAVE THESE INSTRUCTIONS

3 Installation Instructions





WARNING - Risk of fire

- The clothes dryer (“appliance”) installation must be performed by a qualified installer.
- Install the appliance according to the manufacturer’s instructions and local codes.
- Do not install a clothes dryer with flexible plastic venting materials. If flexible metal (foil type) duct is installed, it must be of a specific type identified by the appliance manufacturer as suitable for use with clothes dryers. Flexible venting materials are known to collapse, be easily crushed, and trap lint. These conditions will obstruct the clothes dryer’s airflow and increase the risk of fire.
- To reduce the risk of severe injury or death, follow all installation instructions.

3.1 Electrical connection

Connect the appliance to a grounded outlet protected by a fuse or circuit breaker of suitable capacity.

 <p>4-wire receptacle (14-30R)</p>	<p>Dryer shipped with cord to fit this type 4-wire receptacle</p>
 <p>3-wire receptacle (10-30R)</p>	<p>If you have 3-wire receptacle, like this, a 3-wire dryer cord must be purchased locally.</p>



Neutral connection is not used in this product

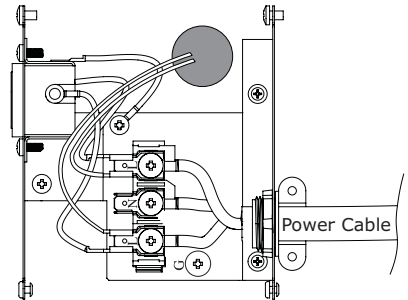

3-Wire Electrical Connection

If your receptacle is a 3-wire receptacle as shown below, you must obtain a 3-wire dryer cord. A dryer cord can usually be found at your local hardware supply, electrical supply or home center. Cord should have closed loop or upturned end wire terminating connectors. The cord kit must be marked “For Use with Clothes Dryers”.

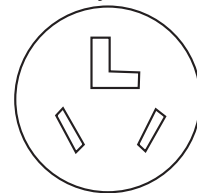

3- wire receptacle
(10-30R)

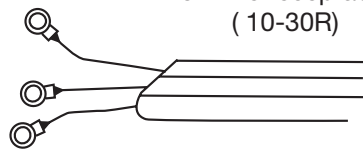

Typical 3- Wire Dryer Cord 240V/30 amp
NEMA 10-30 Type SRDT



If the dryer is installed in a mobile home, recreational vehicles, new branch-circuit installations or in areas where local codes do not permit grounding through the neutral conductor, only a 4-wire power supply cord shall be used.

To change the cord:

1. Make sure that the dryer is not plugged into any power outlet.



DO NOT plug end of dryer power cord into a live receptacle before connecting dryer power cord to dryer terminals and closing junction/splitter box as described below.



DO NOT repair old power supply cords. Power cord must be changed only by a qualified person. There is a risk of electric shock!

2. Remove the screw from the cover of the junction box located at the top rear of the dryer.
3. Remove the red, white and black wire from the terminal block.
4. Remove the green ground wire from the ground terminal.
5. Loosen the strain relief clamp holding the 4-wire cable.
6. Thread the 4-wire cable out through the strain relief clamp.
7. Thread the new 3-wire dryer cord through the strain relief clamp.
8. Attach the power cord Ground conductor (the center wire) to the terminal labeled N. Connect the terminal labeled N and the Ground terminal labeled G. Tighten the terminals so that they securely hold the conductors.
9. Attach the two remaining power cord outer conductors to the 2 terminals labeled L. Tighten both screws so that the power conductors are securely held in place.
10. Tighten the strain relief so that the power cord cannot be moved.
11. Replace the cover on the junction box and fasten in place.

The dryer is now ready to be plugged into the 3-wire receptacle of the proper rating.

The receptacle should be located so that the plug and receptacle will be accessible with the dryer in its installed position.

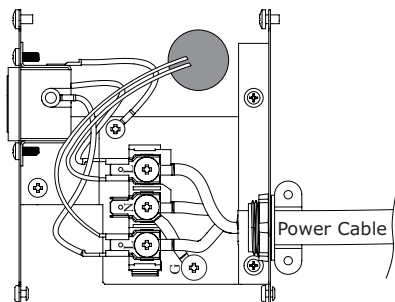

3.2 Grounding Instructions

This appliance must be grounded. In the event of malfunction or breakdown, grounding will reduce the risk of electric shock by providing a path of least resistance for electric current. This appliance is equipped with a cord having an equipment-grounding conductor and a grounding plug. The plug must be plugged into an appropriate outlet that is properly installed and grounded in accordance with all local codes and ordinances.

- Power cord plug must be within easy reach after installation.
- The voltage and the allowed fuse/breaker protection are specified in the section "Technical Specifications".
- The stated voltage must match your mains voltage.
- Connection via extension cords or multi-plugs should not be made.
- The main fuse/breaker and switches must have a contact distance of minimum 3 mm.



A damaged power cable must be replaced by a qualified electrician.



WARNING – Improper connection of the equipment-grounding conductor can result in a risk of electric shock. Check with a qualified electrician or service representative or personnel if you are in doubt as to whether the appliance is properly grounded. Do not modify the plug provided with the appliance: if it will not fit the outlet, have a proper outlet installed by a qualified electrician.



The appliance must not be operated unless it is repaired!
There is the risk of electric shock!

3.3 Appropriate installation location

- Install your appliance in environments that have no risk of freezing and in a stable and level position.
- Do not place your appliance on a long pile rug or on similar surfaces.
- Operate your appliance in a well-ventilated, dust-free environment.
- Do not block the air ducts in front of and under the dryer.



Make sure that your appliance is not placed on the power cable.



Keep at least 0.6" (1.5 cm) from the edges of other furniture.

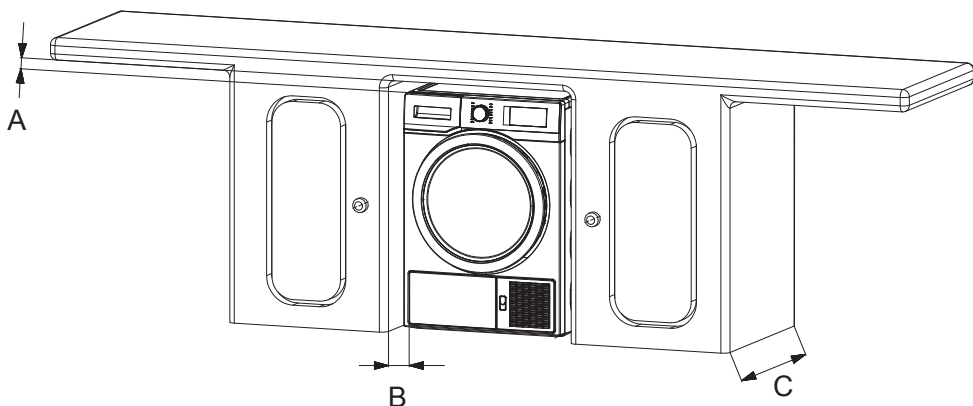

3.4 Minimum Installation Clearances

		Alcove or Built-under	Closet
A	Sides	0.5 in. (13 mm)	0.5 in. (13 mm)
B	Top	1 in. (25 mm)	1 in. (25 mm)
C	Rear	0.5 in. (13 mm)	0.5 in. (13 mm)
	Front	0.20 in. (5 mm)	0.20 in. (5 mm)

Ventilation Requirements

Closet door must have 2 openings, one located 3.2 inches (8 cm) from bottom of door having a minimum area of 16 sq. inches (103 cm²) and the other one located 3 inches (7.5 cm) from top of door having a minimum area of 46 sq. inches (294 cm²).

3.5 Use on top of a washer

- A stacking-kit (Part no: 298 540 0200) should be used between washer and dryer for use on top of a washer. The stacking-kit should be installed by the Authorized Service provider.
- Place the appliance on a solid floor. If it is to be placed on top of a washer, the approximate weight together may reach 397 lbs (180 kg) when they are full. Therefore, the floor must be capable of carrying the load placed on it!

3.6 Adjusting the feet

- In order to ensure that the dryer operates more silently and vibration-free, it must stand level and balanced on its feet. Balance the dryer by adjusting the feet.
- Turn the feet to left or right until the dryer stands level and firmly.

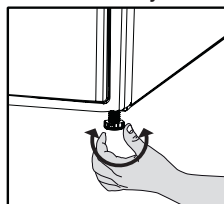

Never unscrew the adjustable feet from their housings.

3.7 Destroying packaging material

Packaging material can be dangerous to children. Keep the packaging materials out of the reach of children or dispose of them accordingly. Do not dispose of them together with normal domestic waste. Packaging materials of your appliance are manufactured from recyclable materials.

3.8 Connecting to the drain

In products equipped with condenser unit, water accumulates in the water tank during the drying cycle.

Connecting the water drain hose

- 1-2 Connect one end of the drain hose supplied with the dryer to the connection point from where you removed the hose of the product in previous step.
- 3 Connect the other end of the drain hose directly to the wastewater drain or to the washbasin.

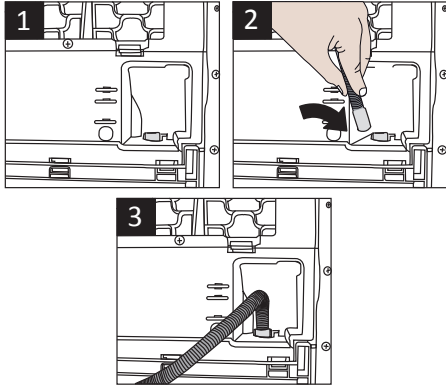

	Hose connection should be made in a safe manner. Your drain house will be flooded if the hose comes out of its housing during water discharge.
	Water drain hose should be attached to a height of maximum 80 cm.
	Make sure that the water drain hose is not stepped on and it is not folded between the drain and the dryer.

4 Preparation

4.1 Laundry suitable for drying in the dryer

Always obey the instructions given on the garment tags. Dry only the laundry having a label stating that they are suitable for drying in a dryer and make sure that you select the appropriate programme.

LAUNDRY DRYING SYMBOLS																					
	Drying Symbols		Suitable for dryer		No Iron		Sensitive / Delicate dry		Do not dry with dryer		Do not dry		Do not dry-clean								
	Drying Settings		At any temperature		At high temperature		At medium temperature		At low temperature		Without heating		Hang to dry		Lay to dry		Hang wet to dry		Lay in shadow to dry		Dry-cleanable
			Iron -		Iron at high temperature		Iron at medium temperature		Iron at low temperature		Do not iron		Iron without steam								
IRON	Dry or Steam			200 °C 392 °F		150 °C 302 °F		110 °C 230 °F													
	Maximum temperature																				

4.2 Laundry not suitable for drying in the dryer



Delicate embroidered fabrics, woolen, silk garments, delicate and valuable fabrics, airtight items and tulle curtains are not suitable for dryers.

4.3 Preparing laundry for drying

- Laundry may be tangled with each other after washing. Separate the laundry items before placing them into the dryer.
- Dry garments having metal accessories such as zippers, inside out.
- Fasten the zippers, hooks and buckles and button sheets.

4.4 Things to be done for energy saving

Following information will help you use the dryer in an ecological and energy-efficient manner.

- Spin your laundry at the highest speed possible when washing them. Thus, the drying time is shortened and energy consumption is reduced.
- Sort out the laundry depending on their type and thickness. Dry the same type of laundry together. For example thin kitchen towels and table clothes dries earlier than thick bathroom towels.
- Follow the instructions in the user manual for programme selection.
- Do not open the loading door of the dryer during drying unless necessary. If you must certainly open the loading door, do not to keep it open for a long time.

- Do not add wet laundry while the dryer is in operation
- Clean the lint filter before or after each drying cycle. **(See 7. Maintenance and cleaning)**
- Clean the filter drawer regularly either when the Filter Drawer Cleaning warning symbol appears or after every 3 drying cycles. **(See 7. Maintenance and cleaning)**
- Ventilate the room, where the dryer is located, well during drying.

4.5 Correct load capacity

Follow the instructions in the “Programme selection and consumption table”. Do not load more than the capacity values stated in the table.

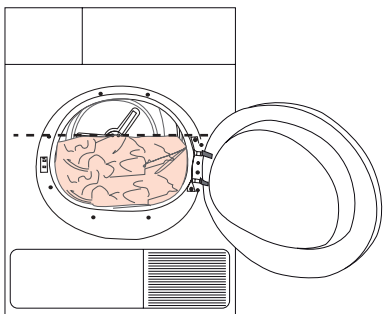

It is not recommended to load the dryer with laundry exceeding the level indicated in the figure. Drying performance will degrade when the dryer is overloaded. Furthermore, dryer and the laundry can get damaged.

Following weights are given as examples.

Home articles	Weight (g)*	Weight (lb)*
Cotton quit covers (double)	1500	3 ¼
Cotton quit covers (single)	1000	2 ¼
Bed sheets (double)	500	1 1/8
Bed sheets (single)	350	¾
Large tablecloths	700	1 ½
Small tablecloths	250	½
Tea napkins	100	¼
Bath towels	700	1 ½
Hand towels	350	¾
Garments	Weight (g)*	Weight (lb)*
Blouses	150	3/8
Cotton shirts	300	5/8
Shirts	200	½
Cotton dresses	500	1 1/8
Dresses	350	¾
Jeans	700	1 ½
Handkerchiefs (10 pieces)	100	¼
T-Shirts	125	¼

*Dry laundry weight before washing.
Approximate weights of average home laundry type.

5 Operating the product

5.1 Control panel

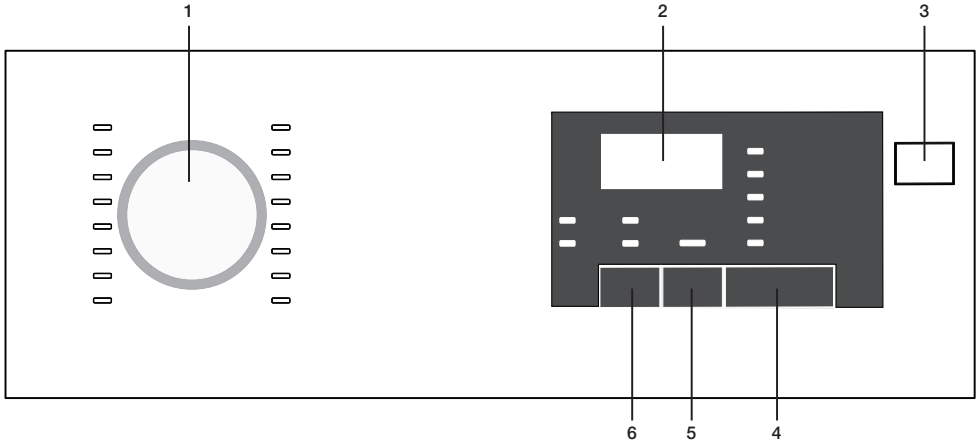

1. Program selection knob
2. Remaining duration indicator
3. On/Off button
4. Start/pause button
5. End duration button
6. Sound warning button

5.2 Screen symbols

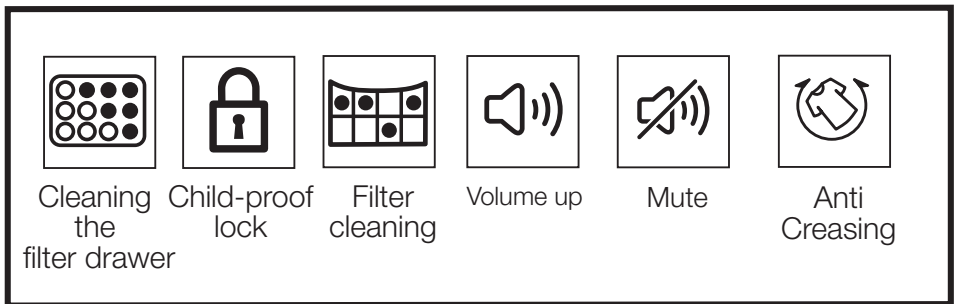

5.3 Preparing the dryer

1. Plug in the dryer
2. Place laundry inside the dryer.
3. Press the On/Off button.
4. When your dryer turns on for the first time, it turns on with the regular dry program.



Pressing the On/Off button doesn't mean the program starts. Press the Start / Pause button to start the program.

5.4 Program selection

1. Determine the appropriate program from the chart below containing the drying levels.
2. Select the program you desire using the Program Selection knob.

Cottons Extra Dry	Only cotton laundry is dried in normal temperature. Thick and multi-layered laundry (towels, sheets, jeans etc.) are dried so that they can be placed into wardrobe without ironing.
Regular dry	Normal laundry (tablecloths, underwear etc.) are dried so that they can be placed into wardrobe without ironing.
Damp Dry	Normal laundry (shirts, dresses etc) are dried ready for ironing.



For detailed program information see. „Program selection and consumption table“..

5.5 Main programs

The main programs are given below based on fabric type.

• Cotton

Dry durable laundry with this program. It dries in normal temperature. Recommended for use with your cotton laundry (sheets, bed covers, towels, bathrobes etc.)

• Synthetic

Dry laundry that is not very durable with this program. Recommended for use with your synthetic laundry.

5.6 Extra programs

The following extra programs are available in the dryer for special conditions.



In order to receive better results from dryer programs, your laundry should be washed with the appropriate program in your washer and wringed with recommended wringing revolution..

• Jeans

Use to dry jeans that are wringed with high rpm in washer.

• Jogging Wear

Use to dry laundry made from synthetic, cotton or mixed fabrics.

• Sensor Drying 45

You can use this program to dry cotton laundry that you had wringed in high rpm in your washer. It dries 1 kg of your Cotton laundry (3 shirts / 3 T-shirts) in 45 minutes.

• Wool

Use this programme to ventilate and soften the woollen laundry that can be washed in the washer. Do not use to dry the laundry completely. Take out and ventilate the laundry immediately after the programme is over.

• Silent

In this programme the level of noise emitted to the environment will be the lowest. Volume level will be fifty percent lower with respect to the 'wardrobe dry for cottons' programme.

• Baby Sanitize

Program used for baby clothing which can be dried according to the label on the clothing.

• Bulky

Dry only fibre quilts with dryerable label.

Load the quilt in the correct way to avoid damages on the dryer and the quilt. Take out the quilt cover before loading the quilt in the dryer. Fold the quilt in two before loading.

- Do not load more than 1 piece of fiber duvet for two persons (200x200 cm).
Do not dry items containing cotton such as quilts, pillows and etc.

- Do not dry items other than quilts such as carpets, rugs or mats. Permanent damage may arise in your dryer.

- **Quick Dry 30**

Dries shirts more delicately and thus causes less wrinkles for easy ironing.



Very little dampness might remain on the shirts after the program. It is recommended that you do not leave the shirts in the dryer.

- **Delicates**

You can dry your delicates suitable for drying or laundry that is recommended to hand wash (silk blouses, thin underwear etc.) in low temperature.



It is recommended to dry your delicates in laundry bag to prevent wrinkles and damage. When the program ends, take your laundry out of the dryer immediately and hang them to prevent wrinkles.

- **Air Fluff/No Heat**

It only performs ventilation for 10 minutes without blowing hot air. You can ventilate the cotton and linen clothing that has remained closed for a long duration and remove their odor.









- **Timed Dry**

You can select one of the 10 min., 20 min., 30 min., 40 min., 50 min., 60 min., 80 min., 100 min., 120 min., 140 min. and 160 min. timer programmes to achieve the desired final drying level at low temperatures.



On this program, the dries as long as the set duration, regardless of the drying level.

5.7 Program selection and consumption table

EN					
Programs		Weight (lb)	Spin speed in washing machine (rpm)	Drying time (minutes)	Energy Saver Cycle
Cottons / Coloreds					
	Extra dry	18	Medium	150	
	Regular dry	18	Medium	145	
	Damp dry	18	Medium	100	
Quick Dry 30		3	High	30	
Jeans		9	High	100	
Silent		18	Medium	220	
Jogging Wear		9	Medium	80	
Sensor Drying 45		2	High	45	
Delicates 		4	Low	35	
Baby Sanitize		7	Medium	65	
Bulky		6	Medium	130	
Wool		3	Low	120	
Synthetics					
	Regular dry	4	Low	55	
	Damp dry	4	Low	45	
Contains fluorinated greenhouse gases covered by the Kyoto Protocol. Hermetically sealed. R134a / 0,490 kg					

 EnergySaverCycle

Energy Saver Cycles provides the most energy savings.

5.8 Auxiliary functions

Sound warning cancel

Dryer makes sound warnings when the program is completed. If you don't want sound notifications, press the "Sound Notification" button.

When you press the sound notification button it lights up, and program does not make sound notifications when completed.



You can select this function before or after the program starts.

5.9 Warning symbols



Warning symbols may vary according to the specifications of your dryer.

Fiber filter cleaning

When the program is completed, a warning led lights up, which indicates that the filter has to be cleaned.

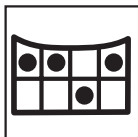

If the filter cleaning led blinks, see the „Troubleshooting“ chapter.

Cleaning the filter drawer

When the program is completed, a warning led lights up, which indicates that the filter has to be cleaned.

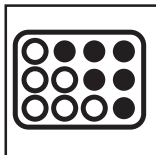

If the filter cleaning led blinks, see the „Troubleshooting“ chapter.

Loading door open

Start/Pause led blinks when the loading door of the dryer is open.

5.10 End duration

You can delay the end duration of the program for up to 24 hours with the end duration function.

1. Open the loading door and place your laundry.
2. Select the drying program.
3. Press the end duration selection button and set the delay duration you want. End duration led lights up. (End duration moves continuously when you keep pressing the button).
4. Press the Start / Pause button. End duration countdown begins. The “.” sign in the middle of the displayed delay duration blinks.



You can add or remove laundry for the duration of the end duration. The duration displayed on the screen is the sum of the normal drying duration and the end duration. At the end of the countdown the end duration led turns off, drying beings and drying led lights up.

Changing the end duration

If you want to change the duration during the countdown:

1. Cancel the program by pressing the On/Off button. Turn on the dryer again by pressing the On/Off button. When your dryer turns on for the first time, it turns on with the declaration (cotton wardrobe dryness) program.
2. Select the program you desire using the Program Selection knob.
3. Repeat the end duration operation for the duration you want.
4. Start the program by pressing the Start / Pause button.

Canceling the end duration function

If you want to cancel the end duration setting countdown and start the program right away:

1. Cancel the program by pressing the On/Off button. Turn on the dryer again by pressing the On/Off button. When your dryer turns on for the first time, it turns on with the declaration (cotton wardrobe dryness) program.
2. Select the program you desire using the Program Selection knob.
3. Start the program by pressing the Start / Pause button.

5.11 Starting the program

Start the program by pressing the Start / Pause button.



Start/Pause led and the Drying led light up, indicating the program started. The “:” sign in the middle of the remaining duration starts to blink.

5.12 Child Lock

The dryer features a child lock which prevents the dryer program flow from being affected when buttons are pressed during operation.

When the Child Lock is active, all buttons except for the On/Off button are deactivated. To activate the child lock, press the Sound Notification button and End Duration button simultaneously for 3 seconds.

The child lock should be deactivated to be able to start a new program after the current program ends or to be able to interfere with the current program. Keep the same buttons pressed for 3 seconds again to deactivate the child lock.

	The lock led on the screen lights up when the Child Lock is activated.
	Child Lock deactivates when the dryer is turned off and on again using the On/Off button.

A warning sound is heard when any button is pressed (except for On/Off button) or the Program Selection knob is turned while the child lock is active.

5.13 Changing the program after it is started





After the dryer starts running, you can change the program you selected to dry your laundry with a different program.

1. For example, to select Extra Dry program instead of the Iron Dryness, stop the program by pressing the Start / Pause button.
2. Turn the Program Selection knob to select the Extra Dry program.
3. Start the program by pressing the Start / Pause button.

Adding and removing laundry in stand-by mode

If you want to add or remove laundry after the drying program starts:

1. Press the Start/Pause button to take the dryer into Stand-by mode. Drying operation stops.
2. Open the loading door, add or remove laundry and close the loading door.
3. Start the program by pressing the Start / Pause button.

	The laundry adding made after the drying operation started may cause the dried laundry inside the dryer to mix with the wet laundry and the laundry to remain damp after the operation ends..
	Laundry adding and removing can be repeated as much as desired during drying operation. But this process would continuously interrupt the drying operation, and so would cause the program duration to lengthen and increase energy consumption. Thus, it is recommended to add laundry before the program starts.
	If a new program is selected by changing the position of the program selection knob while your dryer is in stand-by mode, the running program ends.
	Do not contact the inner surface of the drum when adding or removing laundry during a continuing program. The drum surface is hot.

5.14 Canceling the program

If you want to cancel the program and end the drying operation for any reason after the dryer starts running, press the On/Off button.



As it will be extremely hot inside the dryer when you cancel the program while the dryer is in operation; run the ventilation program to cool it down.

5.15 Program end

When the program ends, the Final/Wrinkle Prevention, Fiber Filter Cleaning and Water Tank Warning leds on the program follow up indicator light up. Loading door can be opened and dryer becomes ready for a second run.

Press the On/Off button to turn off the dryer.



In case the laundry is not removed after the program is completed, the wrinkle prevention program that lasts 2 hours start in order to prevent wrinkling of the laundry that remains inside the dryer.



Clean the fiber filter after each drying. (See. „Fiber filter and loading door inner surface“)



Empty the water tank after each drying. (See. „Emptying the water tank“)

6 Technical Specifications

Model	Heat Pump Dryer with electronic sensor control
Height (in)	33 5/16
Width (in)	23 3/4
Depth (in)	24 1/2
Height adjustment of feet (in)	1/5
Net weight (lbs)	122
Voltage / Frequency	208-240V ~ 60 Hz
Connected load	900 W - 4 A
Dry Load Capacity	8kg / 18 lb
Capacity	4,1 cu-ft

7 Maintenance and cleaning

Service life of product extends and frequently experienced problems will be reduced if it is cleaned at regular intervals.

7.1 Cleaning Lint Filter / Loading Door Inner Surface

Lint and fiber released from the laundry to the air during the drying cycle are collected in the Lint Filter.



Such fiber and lint are generally formed during wearing and washing.



WARNING: Always clean the lint filter and the inner surfaces of the loading door after each drying process.



You can clean the lint filter housing with a vacuum cleaner.

To clean the lint filter:

- Open the loading door.
- Remove the lint filter by pulling it up and open the lint filter.
- Clean lint, fiber, and cotton raveling by hand or with a soft piece of cloth.
- Close the lint filter and place it back into its housing.

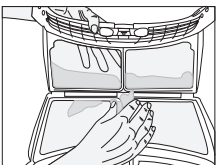
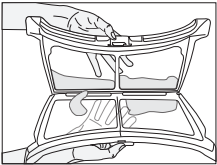
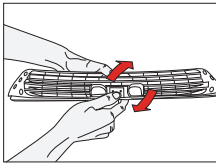
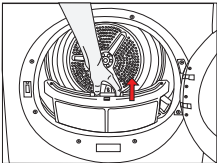

- A layer can build up on the filter pores that can cause clogging of the filter after using the dryer for a while. Wash the lint filter with warm water to remove the layer that builds up on the lint filter surface. Dry the lint filter completely before reinstalling it.

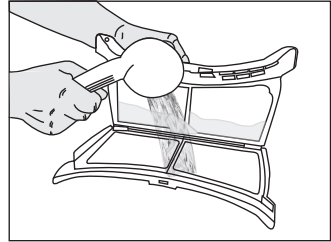

- Clean the entire inner surface of the loading door and loading door gasket with a soft damp cloth.

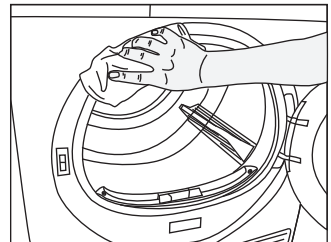
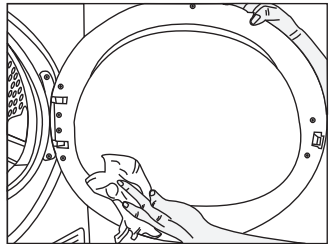

7.2 Cleaning the sensor

There are dampness sensors in the dryer that detect whether the laundry is dry or not.

To clean the sensors:

- Open the loading door of the dryer.
- Allow the dryer to cool down if it is still hot due to the drying process.
- Wipe the metal surfaces of the sensor with a soft cloth, dampened with vinegar and dry them.



Clean metal surfaces of the sensors 4 times a year.



Do not use metal tools when cleaning metal surfaces of the sensors.



WARNING: Never use solvents, cleaning agents or similar substances for cleaning due to the risk of fire and explosion!

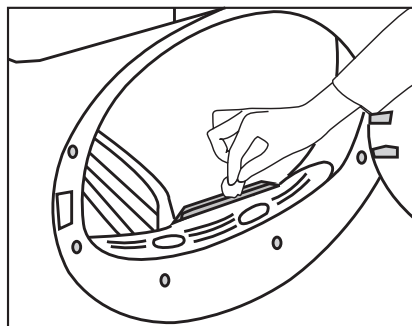

7.3 Cleaning the filter drawer

Lint and fiber that could not be captured by the lint filter are blocked in the filter drawer behind the kick plate. Filter Drawer Cleaning warning light will light up maximum at every 3 drying cycles as a reminder.

There is a two-level filter in the filter drawer. The first level is the filter drawer sponge and the second level is the filter cloth.

To clean the filter drawer:

- Press the kick plate button to open the kick plate.

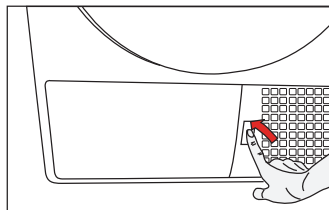

- Remove the filter drawer cover by turning it in the direction of arrow.

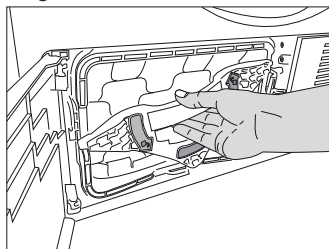

- Pull out the filter drawer.

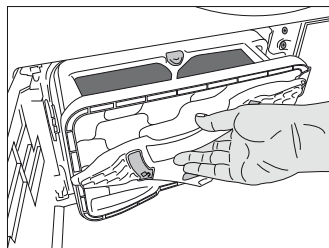

- Open the filter drawer by pressing the red button.

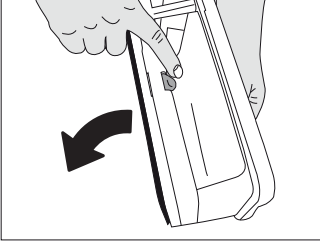

- Take out the filter drawer sponge.

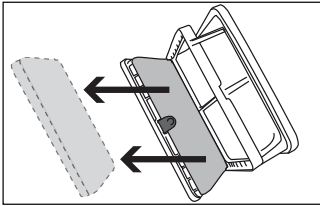

- Clean lint, fiber, and cotton raveling on the filter cloth by hand or with a soft piece of cloth.
- When you notice a layer that may lead clogging on the filter cloth, please clean the layer by washing in warm water. Let the filter cloth dry thoroughly before installing back the filter drawer.

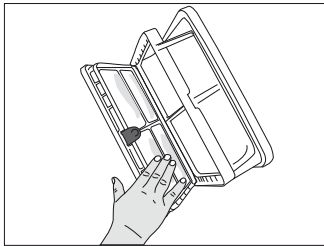

- Wash the filter drawer sponge by hand to remove the fiber and lint on the surface. After washing the sponge, squeeze it by hand and remove the excess water. Well-dry the sponge before storing it.



It is not necessary to clean the sponge if lint and fiber accumulation on it is not significant.

- Place the sponge back into its place.

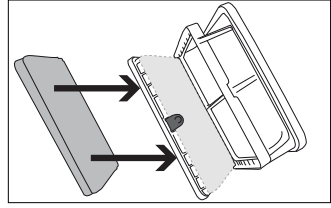

- Close the filter drawer as to lock the red button.

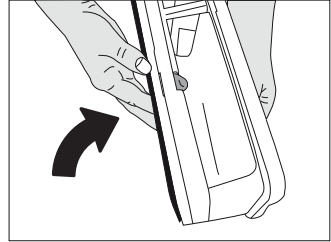

- Place the filter drawer back into its place, turn the filter drawer cover in the arrow direction and close it securely.

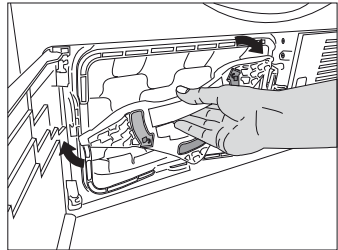

- Close the kick plate cover.

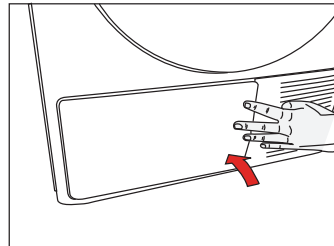

NOTICE: Drying without the filter drawer sponge in place will damage the dryer!



A dirty lint filter and filter drawer will cause longer drying periods and higher energy consumption.

7.4 Cleaning the evaporator

Clean the lint accumulated on the fins of the evaporator located behind the filter drawer with a vacuum cleaner.

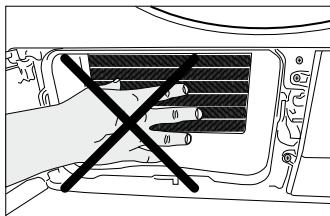

CAUTION: You can also clean by hand provided that you wear protective gloves. Do not attempt to clean with bare hands. Evaporator fins can harm your hand.

8 Troubleshooting

Drying process takes too much time.

- Pores of the lint filter are clogged. >>> Wash the lint filter with warm water.
- Filter drawer is clogged. >>> Clean the sponge and the filter cloth in the filter drawer.
- Ventilation grids on the front side of the machine are blocked. >>> Remove the objects (if any) that block ventilation in front of the ventilation grids.
- Ventilation is not sufficient since the room where the machine is installed is very small. >>> Open the door and window of the room to avoid the room temperature increase too much.
- Lime deposit has built up on the dampness sensor. >>> Clean the dampness sensor.
- Excessive laundry is loaded. >>> Do not load the dryer in excess.
- Laundry is not spun sufficiently. >>> Spin your laundry at a higher speed in your washing machine.

Laundry comes out wet at the end of drying.



After drying, the hot clothes feel damper than their actual dampness level.

- It is likely that the selected programme did not suit the laundry type.>>>Checking the care labels on clothes, select appropriate programme for the laundry type or use timer programmes in addition.
- Pores of the lint filter are clogged. >>> Wash the lint filter with warm water.
- Filter drawer is clogged. >>> Clean the sponge and the filter cloth in the filter drawer.
- Excessive laundry is loaded. >>> Do not load the dryer in excess.
- Laundry is not spun sufficiently. >>> Spin your laundry at a higher speed in your washing machine.

Dryer does not switch on or the programme does not start. Dryer does not start when it is set.

- It is not plugged in. >>> Make sure that the machine is plugged in.
- The loading door is ajar. >>> Make sure that the loading door is closed securely.
- Programme is not selected or the Start / Pause / Cancel button is not pressed. >>> Make sure that the programme is selected and the machine is not in Pause mode.
- Childproof Lock is activated. >>> Deactivate the Childproof Lock.

Programme is interrupted without any cause.

- Loading door is ajar. >>> Make sure that the loading door is closed securely.
- There was a power failure. >>> Press Start / Pause / Cancel button to start the programme.

Laundry has shrunk, become felted or deteriorated.

- A programme suitable for the laundry type is not used. >>> Check the garment tag and select a programme suitable for the fabric type.

Drum lighting does not turn on. (On models with lamp)

- Dryer is not switched on with the On / Off button. >>> Make sure that the dryer is switched on.
- Lamp is defective. >>> Call Authorized Service Agent to have the lamp replaced.

End/Anti-creasing symbol is on.

- Anti-creasing programme is activated in order to prevent laundry that has remained in the machine from creasing. >>> Turn off the dryer and take out the laundry.

End symbol is on.

- Programme is over. Turn off the dryer and take out the laundry.

Lint Filter Cleaning symbol is on.

- Lint filter is not cleaned. >>> Clean the lint filter.

Lint Filter Cleaning symbol is flashing.

- Filter housing is clogged with lints. >>> Clean the lint filter housing.
- A deposit has built up on the lint filter pores that may cause clogging. >>> Wash the lint filter with warm water.
- Filter drawer is clogged. >>> Clean the sponge and the filter cloth in the filter drawer.

Water leaks from the loading door

- Lint has accumulated on the inner surfaces of the loading door and on the surfaces of the loading door gasket. >>> Clean the inner surfaces of the loading door and the surfaces of the loading door gasket.

Loading door opens spontaneously.

- Loading door is ajar. >>> Push the loading door to close until you hear a locking sound.

Filter Drawer Cleaning warning symbol is flashing.

- Filter drawer is not cleaned. >>> Clean the sponge and the filter cloth in the filter drawer.



CAUTION: If you cannot eliminate the problem although you follow the instructions in this section, consult your dealer or the Authorized Service Agent. Never try to repair a nonfunctional product yourself.

9 Warranty Statement

WARRANTY STATEMENT FOR THE BLOMBERG DRYERS

The warranties provided by Blomberg in these statements only apply to Blomberg dryers sold to the original purchaser or homeowner in the US and Canada. The warranty is not transferable. To obtain warranty service, please contact our nearest distributor as listed by state. You will need your dryer model number, serial number, retailer name and address, where purchased and purchase date / installation date. This warranty gives you specific legal rights, and you may also have other rights, which vary from state to state.

1 year *** limited warranty from date of first installation Blomberg will repair or replace at no cost to the consumer any defective parts of the dryer if used under normal household conditions (warranty is void if the product is used commercially e.g., bed + breakfast, nursing home etc.). Service must also be performed by an authorized Blomberg service agency. (Cosmetic defects must be reported within 10 business days from installation)

The accessories have 1 year warranty but not labor. Consumer is responsible for labor to install accessory.

2 year * ++ limited warranty from date of first installation (Parts only) Blomberg will repair or replace any parts at no cost to the consumer if material defects or workmanship have caused the damage or failure of these components. Again the dryer must have been used under normal household conditions and not commercially as stated above (Labor charges are the responsibility of the consumer).

5 year * ++ limited warranty from date of first installation (parts only 2-5 years) Blomberg will repair or replace any circuit boards or dryer drum (excluding any plastic attachments) at no cost to the consumer if material defects or workmanship have caused the damage or failure of these components. The dryer must have been used under normal household conditions and not commercially (Labor charges are the responsibility of the consumer).

Lifetime limited warranty from date of first installation -++ (parts only) Blomberg will repair or replace to the original owner the stainless steel drum if rust through occurs under normal household use. Blomberg may, at its option, also replace the whole dryer with the same and/or equivalent model with equal or better functionality if the original model is no longer available. (Labor, removal and installation charges are the responsibility of the consumer.)

This product is fully tested and went through official quality assurance inspections before leaving the original manufacturing site. Warranty terms for this Blomberg household appliance is not valid if the product is altered, tampered, modified, additional parts assembled, fixed and re-packed by an authorized distributor, servicer, a third party retailer, reseller or by any other unauthorized person(s)

Disclaimers of warranties and exclusions:

Warranty does not cover service costs by an authorized service agent to correct installation, electrical and plumbing problems or educational instruction on the use of the dryer. The warranty also does not cover defects or damage caused by an act of god (such as storms, floods, fires, mudslides, etc.), damage caused by use of the dryer for purposes other than those for which it was designed, misuse, abuse, accident, alteration, improper installation, maintenance, travel fees, service calls outside normal service hours, unauthorized service work or servicers.

TO THE EXTENT PERMITTED BY LAW, THIS WARRANTY IS IN LIEU OF ALL OTHER EXPRESSED AND IMPLIED WARRANTIES, INCLUDING THE IMPLIED WARRANTIES OF MERCHANTABILITY AND FITNESS FOR A PARTICULAR PURPOSE. BLOMBERG UNDERTAKES NO RESPONSIBILITY FOR THE QUALITY OF THIS PRODUCT EXCEPT AS OTHERWISE PROVIDED IN THIS WARRANTY STATEMENT. BLOMBERG ASSUMES NO RESPONSIBILITY THAT THE PRODUCT WILL BE FIT FOR ANY PARTICULAR PURPOSE FOR WHICH YOU MAY BE BUYING THIS PRODUCT, EXCEPT AS OTHERWISE PROVIDED IN THIS WARRANTY STATEMENT.

Blomberg does not assume any responsibility for incidental or consequential damages. Such damages include, but are not limited to, loss of profits, loss of savings or revenue, loss of use of the dryer or any associated equipment, cost of capital, cost of any substitute equipment, facilities or services, downtime, the claims of third parties, and injury to property. Some states do not allow the exclusion or limitation of incidental or consequential damages, so the above limitations or exclusion may not apply to you.

* Installation date shall refer to either purchase date or 5 business days after delivery of the product to the home, whichever is later.

++ Parts replaced will assume the identity of the original parts + their original warranty.

There are No Other Warranties. This Warranty Statement is the complete and exclusive warranty from the manufacturer. No employee of Blomberg or any other party is authorized to make any warranty statements in addition to those made in this Warranty Statement.

HOW TO GET SERVICE

Please contact the Distributor for your State or Province as listed on the Distributor Contact List, or call our Toll Free Number at 1 800 459 9848 for direction to an Authorized Blomberg Service Agent or contact via <http://www.blombergappliances.com>

Blomberg®

seit 1883

www.blomberginternational.com
info@blomberginternational.com